

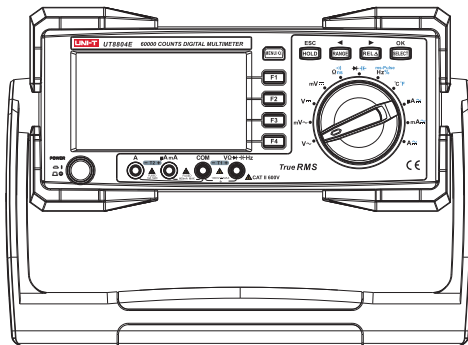

UNI-T®

UT8804E

Benchtop Color Display Digital Multimeter User Manual



 Warning: Do not use this product under CAT II, CAT III and CAT IV environments when the voltage being measured >600V.

I. Overview

UT8804E is a 60000-count benchtop digital multimeter (hereinafter referred to as the meter) with auto range, color display and true RMS measurement functions. Its circuit design adopts large scale integrated circuit (LSI) A/D conversion, microprocessor, multifunction measurement and high stable thin-film resistor manufacturing technology, which makes it a digital multimeter with superior performance. The meter can be used to measure AC/DC voltage, AC/DC, resistance, conductance, diode, continuity, capacitance, temperature, frequency, pulse width, etc. Besides, it also has data hold, max/min/mean value measurement, comparison function measurement, relative value measurement, peak detection, tendency chart capture, and up to 20,000 data recording/readback functions. The integrated 4.3-inch color display provides multi-level, all-round and clear display of measurement results with both readings and tendency charts.

This manual contains relevant safety and warning information. Please read the contents carefully and strictly follow all warnings and cautions.

 Warning: Before using the meter, please read the safety instructions carefully.

II. Unpacking Inspection

Open the packing box and take out the meter. Please double check whether the following items are deficient or damaged, and contact your supplier immediately if they are.

User manual -----	1 pc
Test leads-----	1 pair
Alligator clip short test leads-----	1 pair
K-type temperature probe-----	2 pcs
Power cable (AC 110V)-----	1 pc
Software application CD -----	1 pc
USB interface wire -----	1 pc

III. Safety Instructions

The meter strictly follows the EN 61010-1: 2010, EN 61326: 2013, RoHS, CAT II 600 V, double insulation standard and safety standard of pollution grade II.

Note: In case the meter is not used in accordance with the operating instructions, the protection provided by the meter may be weakened or lost.

1. Before using the meter, please check if there is any item which is damaged or behaving abnormally.

If any abnormal item (such as bare test lead, damaged housing case, broken LCD, etc.) is found, please do not use the meter. It is strictly prohibited to use a meter without shell cover. Otherwise, there is danger of electric shock.

- 2.If the test lead is damaged, it must be replaced with one of the same model or the same electrical specifications.
- 3.When measuring, do not touch any exposed wires, connectors, unused inputs or the circuits being measured.
- 4.When measuring the voltage higher than 48 V (DC) or 36 Vrms (AC), keep your fingers behind the finger guard ring of the test leads to prevent electric shock.
- 5.If the range of the voltage to be measured is unknown, the maximum range should be selected and then gradually decreased. Do not use the low pass filter option to verify if there is hazardous voltage, which may exceed the indicated value. First, measure the voltage without a filter to detect the presence of hazardous voltage. Then select the filter function.
- 6.Never input voltage and current which exceeds the rated range indicated on the meter housing.
- 7.Before switching the function knob to select the measuring range, make sure to disconnect the test leads from the measured circuit. Never change the range setting when measuring to avoid damage to the meter.
- 8.Do not use or store the meter in high temperature, high humidity, flammable, explosive and strong magnetic field environments.
- 9.Do not change the internal circuit of the meter to avoid damage to the meter and user.
- 10.After measurement, turn off the power. If the meter is not in use for a long time, please unplug the power cord.

Hazardous voltage

When the meter detects a value ≥ 30 V or voltage overload (OL), the  symbol is displayed as a warning of the underlying hazardous voltage.

IV. Comprehensive Index

1. Max voltage between input terminal and COM terminal: 1000V (DC/AC)
2. μ A, mA input terminal protection: (CE) F1, F600mA 1000V, Φ 6x32mm fast-acting fuse
3. 10A input terminal protection: (CE) F2, 11A H 1000V, Φ 10x38mm fast-acting fuse
4. Display: Full icon display; max value: 60,000; refresh rate: 2~3 times/s
5. Range: Auto/Manual
6. Polarity display: Auto
7. Overrange indication: OL
8. Operating temperature: 0~40°C (32°F~104°F)
9. Storage temperature: -10~50°C (14°F~122°F)
10. Relative humidity: $\leq 75\%$ at 0°C~30°C; $\leq 50\%$ at 30°C~40°C
11. Temperature coefficient: $0.1 \times (\text{specified accuracy})/^\circ\text{C}$ ($<18^\circ\text{C}$ or $\geq 28^\circ\text{C}$)
12. Electromagnetic compatibility:
RF=1V/m, overall accuracy=specified accuracy+5% of range
RF>1V/m, no specified calculation
13. Power supply: AC 100V/120V/220V/240V, 47~63Hz
Protection fuse being used: 0.25 A x 250 V
14. Dimensions: 320mm*265mm*110mm
15. Safety standard: IEC 61010: CAT II 600V

V. LCD Screen



Item	Function	Description
1	Menu	Menu functions such as measurement, storage, statistics and settings
2	Buzzer	Indicates that the buzzer of the meter is enabled (not related to the continuity test alarm)
3	Communication	Indicates activity on the communication link
4	Hold symbol	Indicates data hold mode
5	Small measurements	If the main and auxiliary display screens are covered by menu or pop-up information, the real-time input value is displayed here.
6	Date and time	Indicates the set time and date of the internal clock
7	Range indicator	Indicates the current range and range mode of the meter (auto or manual)
8	Lightning symbol	There is hazardous voltage at the input.
9	Simulation bar	Simulates and displays the input signal quickly
10	Auxiliary display	Displays auxiliary measurement information about the input signal

VI. Function Introduction



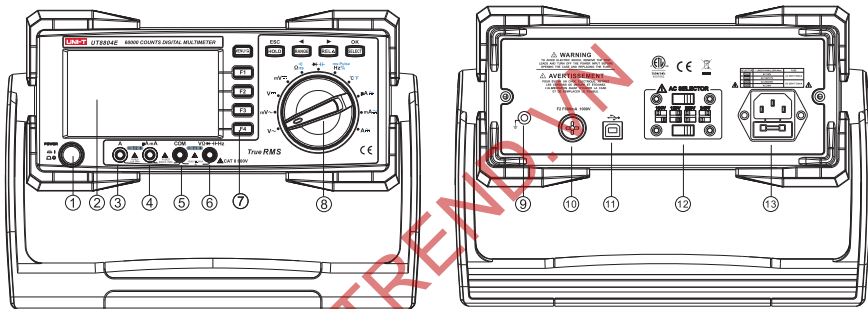



1. External Structure



1	Power switch	8	Function knob
2	TFT display screen	9	Grounding terminal
3	A current input jack	10	Fuse knob (F1 600mA)
4	μA and mA input jack	11	USB interface
5	COM jack	12	AC voltage selector
6	Input jack for other measurement	13	Socket
7	Function buttons		

2. Function Buttons

The nine buttons on the meter are used to activate the features of the function selected through the knob and browse menus. The buttons shown below are described in the table.

	<p>Open or close the menu by pressing this button. Long press this button for 1 second to switch backlight brightness.</p>
	<p>Use these buttons to select the corresponding menu functions.</p>
	<p>When the menu is displayed, this button is used to exit the submenu. Otherwise, for data hold.</p>
	<p>When the menu is displayed, this button is used to control the cursor to scroll up and select the relevant sub-functions and modes. Otherwise, it is used to switch the range mode of the meter to manual mode and then change between all available ranges in turn. To return to the auto range selection, press this button for 1 second.</p>
	<p>When the menu is displayed, this button is used to control the cursor to scroll down and select the corresponding sub-function menu. Otherwise, it is used for relative value measurement mode. To exit the relative value measurement mode, long press this button for 1 second.</p>
	<p>When the menu is displayed, this button is used to enter the submenu function and mode selected through the cursor. Otherwise, it is used for the composite function of the SELECT setting.</p>

3. Function Knob

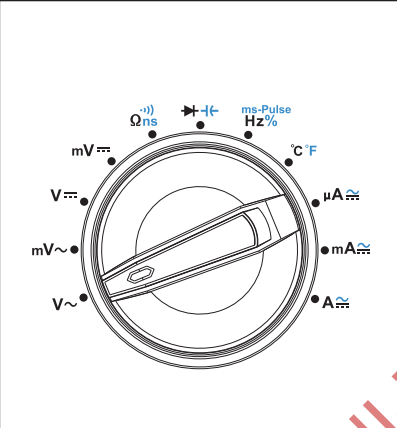

Position	Functions
V~	AC voltage measurement
mV~	AC and AC+DC millivolt measurement
V⋯	DC and AC+DC voltage measurement
mV⋯	DC millivolt measurement
Ωns	Resistance, continuity and conductance measurement
▶ ◀	Diode and capacitance measurement
ms-Pulse Hz%	Frequency, duty ratio and pulse width measurement
°C °F	Temperature measurement
μA ≈	AC, DC and AC+DC microampere measurement
mA ≈	AC, DC and AC+DC milliampere measurement
A ≈	AC, DC and AC+DC ampere measurement

4. Input Jacks for the Test Leads

Jacks	Description
A	This input jack is used to measure 0A to 10.00A current (20A overload lasts for up to 30 seconds, and then interrupts for 10 minutes) and frequency.
μA mA	This input jack is used to measure 0A to 600mA current and frequency.
COM	This common jack is used for all measurement.
VΩ▶←Hz	This input jack is used to measure voltage, continuity, resistance, diode, conductance, capacitance, frequency, cycle and duty ratio.

In addition to the above, the four jacks can be used for temperature measurement function through the corresponding adapter.

If the test leads are incorrectly inserted, "Lead Error!" will be displayed on the screen as a warning.

VII. Operating Instructions

1. Turning on the Meter Power

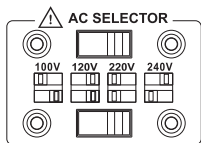

First, set the power. As shown on the left, flick the red selector to the corresponding 100V/120V/220V/240V power position correctly. Please do not make a mistake. Otherwise, the fuse in the power socket will be blown. After that, press the power switch to turn on the power.

2. AC Voltage Measurement

- 1) Insert the red test lead into the “V” jack, black into the “COM” jack.
- 2) Turn the function knob to the $V\sim$ position. And then connect the test leads with the power supply or the load in parallel (as shown below).

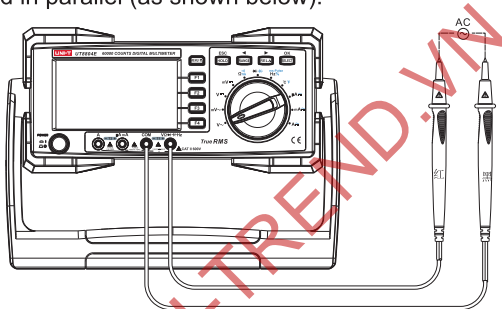

- 3) Read the measured voltage value directly from the display (true RMS for AC measurement).
- 4) Press the MENU button to open the main menu, press the F1 button to open the submenu of the measurement mode, and control the cursor to select voltage + frequency, peak value, low pass filtering, dBV, dBm and other measurement modes.
- 5) In the voltage + frequency measurement mode, the main display is voltage while the auxiliary display is frequency and cycle.
- 6) In the peak value measurement mode, the positive peak (Peak Max) and negative peak (Peak Min) are displayed.

- 7) In the low pass filtering measurement mode, the AC signal passes through a filter that intercepts voltage higher than 1 kHz. As shown below, the low pass filter can measure the signal on the composite sine wave generated by the inverter and the variable-frequency motor.

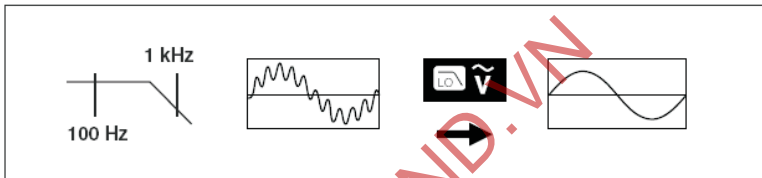

- 8) In the dBV measurement mode, the main display is dBV, the auxiliary display is the corresponding AC voltage value, and the simulation bar displays the AC voltage of the measured signal.
 $\text{dBV} = 20\lg(\text{input voltage (V)})$
- 9) In the dBm measurement mode, the main display is dBm, the auxiliary display is the corresponding AC voltage value and the reference impedance value, and the simulation bar displays the AC voltage of the measured signal. dBm is a value representing the absolute value of power, that is, decibels above one milliwatt in 600 ohms. When measuring, reference impedance (resistance) shall be used to calculate the dB value on the basis of 1 mW.
 Formula: $\text{dBmV} = 10\lg(\text{input voltage} * \text{input voltage} / R) (\text{mW})$; R is optional resistance (4Ω-1200Ω). The setting procedures are as follows:
- a) After entering the settings option of the main menu, control the cursor to select the “Set dBm Reference Value” submenu.

- b) After entering the “Set dBm Reference Value” submenu, press the F2 (“◀”) or F3 (“▶”) button to scroll between the ten defined reference values (4, 8, 16, 25, 32, 50, 75, 600, 1000 and Modify). When selecting the "Modify" menu option, press the F2 or F3 button to modify the number and the “◀” or “▶” button to select the editing position. Any reference impedance value from 4Ω to 1200Ω can be selected.
- c) Press the F1 button to confirm the selection.

⚠ Note:

- Do not input any voltage higher than 1000V. Otherwise, there is a risk of damaging the meter.
- Be cautious to avoid electric shock when measuring high voltage.
- In the low pass filtering measurement mode, the meter will switch to manual mode. Auto range is not available. Press the RANGE button to select the range.
- After finishing all measurement operations, disconnect the test leads from the measured circuit.
- The accuracy of non-sinusoidal waves must be adjusted as follows:
 - Add 1.0% when crest factor is 1.4~2.0
 - Add 2.5% when crest factor is 2.0~2.5
 - Add 4.0% when crest factor is 2.5~3.0

3. AC Millivolt Voltage Measurement

- 1) Insert the red test lead into the “V” jack, black into the “COM” jack.
- 2) Turn the function knob to the $mV\sim$ position. And then connect the test leads with the power supply or the load in parallel (as shown below).

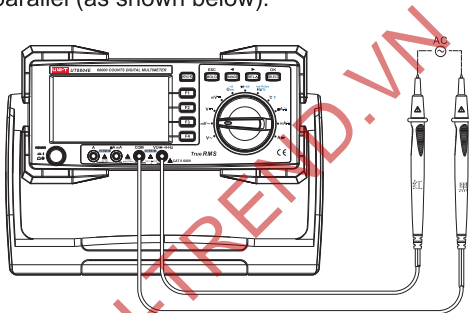

- 3) Read the measured voltage value directly from the display (true RMS for AC measurement).
- 4) Press the MENU button to open the main menu, press the F1 button to open the submenu of the measurement mode, and control the cursor to select voltage + frequency, peak value, AC+DC and other measurement modes.
- 5) In the voltage + frequency measurement mode, the main display is millivolt voltage while the auxiliary display is frequency and cycle.
- 6) In the peak value measurement mode, the positive peak (Peak Max) and negative peak (Peak Min) are displayed.

- 7) In the AC+DC measurement mode, the main display is AC+DC value, defined as $\sqrt{ac^2+dc^2}$, and the auxiliary display is AC component and DC component.

⚠ Note:

- Do not input any voltage higher than 1000V. Otherwise, there is a risk of damaging the meter.
- Be cautious to avoid electric shock when measuring high voltage.
- After finishing all measurement operations, disconnect the test leads from the measured circuit.
- The accuracy of non-sinusoidal waves must be adjusted as follows:
 - Add 1.0% when crest factor is 1.4~2.0
 - Add 2.5% when crest factor is 2.0~2.5
 - Add 4.0% when crest factor is 2.5~3.0

4. DC Voltage Measurement

- 1) Insert the red test lead into the “V” jack, black into the “COM” jack.
- 2) Turn the function knob to the **V_{DC}** position. And then connect the test leads with the power supply or the load in parallel (as shown below).

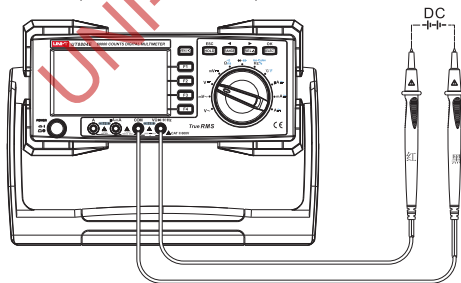

- 3) Read the measured voltage value directly from the display.
- 4) Press the MENU button to open the main menu, press the F1 button to open the submenu of the measurement mode, and control the cursor to select peak value, AC+DC and other measurement modes.
- 5) In the peak value measurement mode, the positive peak (Peak Max) and negative peak (Peak Min) are displayed.
- 6) In the AC+DC measurement mode, the main display is AC+DC value, defined as $\sqrt{ac^2+dc^2}$, and the auxiliary display is AC component and DC component.

⚠ Note:

- Do not input any voltage higher than 1000V. Otherwise, there is a risk of damaging the meter.
- Be cautious to avoid electric shock when measuring high voltage.
- After finishing all measurement operations, disconnect the test leads from the measured circuit.

5. DC Millivolt Voltage Measurement

- 1) Insert the red test lead into the “V” jack, black into the “COM” jack.
- 2) Turn the function knob to the mV position. And then connect the test leads with the power supply or the load in parallel (as shown below).

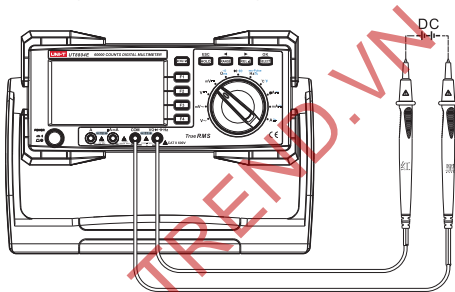

- 3) Read the measured voltage value directly from the display.
- 4) Press the MENU button to open the main menu, press the F1 button to open the submenu of the measurement mode, and control the cursor to select the peak value measurement mode.
- 5) In the peak value measurement mode, the positive peak (Peak Max) and negative peak (Peak Min) are displayed.

⚠ Note:

- Do not input any voltage higher than 1000V. Otherwise, there is a risk of damaging the meter.
- Be cautious to avoid electric shock when measuring high voltage.
- After finishing all measurement operations, disconnect the test leads from the measured circuit.

6. AC current Measurement

- 1) Insert the red test lead into the “ μA mA” or “A” jack, black into the “COM” jack.
- 2) Turn the function knob to the μA \sim , mA \sim or A \sim position, press the SELECT button to select the AC needed measuring, and then connect the test leads with the circuit to be measured in series (as shown below).

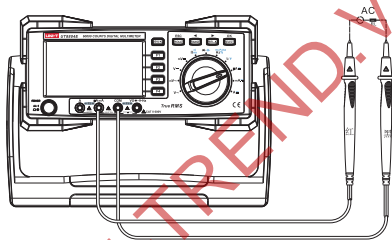

- 3) Read the measured current value directly from the display (true RMS for AC measurement).
- 4) Press the MENU button to open the main menu, press the F1 button to open the submenu of the measurement mode, and control the cursor to select current + frequency, peak value and other measurement modes.
- 5) In the current + frequency measurement mode, the main display is current while the auxiliary display is frequency and cycle.
- 6) In the peak value measurement mode, the positive peak (Peak Max) and negative peak (Peak Min) are displayed.

⚠ Note:

- Before connecting the meter in series with the circuit to be measured, switch off the power supply of the circuit, and fully discharge all high-voltage capacitors.
- Use the correct input port and setting when measuring. If the current cannot be estimated, start the measurement from the large current range.
- When the red test lead is inserted into the current input port, do not connect the probes to any circuit in parallel to avoid damage to the meter.
- After finishing all measurement operations, switch off the power supply, and then disconnect the test leads from the measured circuit.
- The accuracy of non-sinusoidal waves must be adjusted as follows:
 - Add 1.0% when crest factor is 1.4~2.0
 - Add 2.5% when crest factor is 2.0~2.5
 - Add 4.0% when crest factor is 2.5~3.0

7. DC current Measurement

- 1) Insert the red test lead into the “ $\mu\text{A mA}$ ” or “A” jack, black into the “COM” jack.
- 2) Turn the function knob to the μA , mA or A position, press the SELECT button to select the DC needed measuring, and then connect the test leads with the circuit to be measured in series (as shown below).

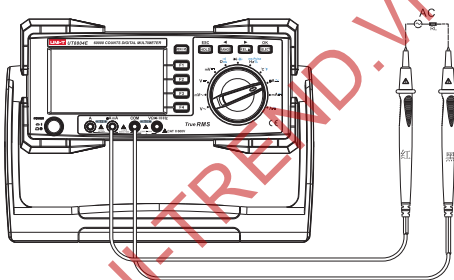

- 3) Read the measured current value directly from the display.
- 4) Press the MENU button to open the main menu, press the F1 button to open the submenu of the measurement mode, and control the cursor to select peak value, AC+DC and other measurement modes.
- 5) In the peak value measurement mode, the positive peak (Peak Max) and negative peak (Peak Min) are displayed.
- 6) In the AC+DC measurement mode, the main display is AC+DC value, defined as $\sqrt{ac^2+dc^2}$, and the auxiliary display is AC component and DC component.

⚠ Note:

- Before connecting the meter in series with the circuit to be measured, switch off the power supply of the circuit, and fully discharge all high-voltage capacitors.
- Use the correct input port and setting when measuring. If the current cannot be estimated, start the measurement from the large current range.
- When the red test lead is inserted into the current input port, do not connect the probes to any circuit in parallel to avoid damage to the meter.
- After finishing all measurement operations, switch off the power supply, and then disconnect the test leads from the measured circuit.

8. Resistance Measurement

- 1) Insert the red test lead into the “ Ω ” jack, black into the “COM” jack.
- 2) Turn the function knob to the Ω_{ns} position, press the SELECT button to select the Ω setting for resistance measurement, and then connect the test leads with the load to be measured in parallel (as shown below).

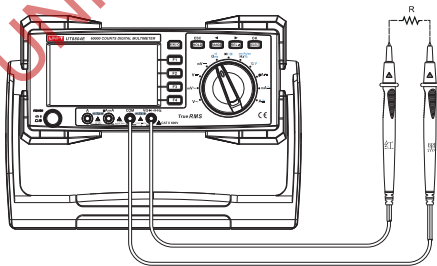

3) Read the measured resistance value directly from the display.

⚠ Note:

- If the measured resistor is open or the resistance exceeds the maximum range, the “OL” symbol will be displayed on the screen.
- Before measuring the resistance online, switch off the power supply of the circuit, and fully discharge all capacitors.
- When measuring low resistance, the test leads will produce 0.1Ω~0.2Ω measurement error. To obtain accurate measurement, short the test leads and press the Δ button to use REL function.
- If the resistance is not less than 0.5Ω when the test leads are shorted, please check if the test leads are loose or abnormal.
- When measuring high resistance above 1MΩ, it is normal to take a few seconds to steady the readings. To obtain steady readings, the short test leads can be used for measurement.
- Do not input voltage higher than AC 30Vrms (peak value 42V) or DC 60V. Otherwise there is a risk of injury to personal safety.
- After finishing all measurement operations, disconnect the test leads from the measured circuit.

9. Conductance measurement

- 1) Insert the red test lead into the “ Ω ” jack, black into the “COM” jack.
- 2) Turn the function knob to the Ω_{ns} position, press the SELECT button to select the 60nS setting for conductance measurement, and then connect the test leads with the load to be measured in parallel (as shown below).

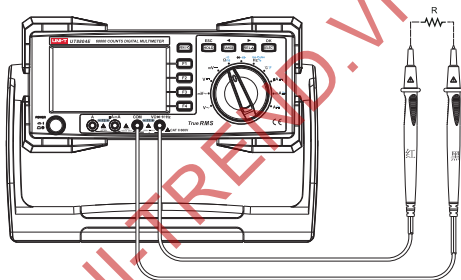

- 3) Read the measured conductance value directly from the display.

⚠ Note:

- Before measuring the resistance online, switch off the power supply of the circuit, and fully discharge all capacitors.
- Do not input voltage higher than AC 30Vrms (peak value 42V) or DC 60V. Otherwise there is a risk of injury to personal safety.
- After finishing all measurement operations, disconnect the test leads from the measured circuit.

10. Continuity Measurement

- 1) Insert the red test lead into the “ Ω ” jack, black into the “COM” jack.
- 2) Turn the function knob to the Ω_{ns} position, press the SELECT button to select the continuity measurement, and then connect the test leads with the load to be measured in parallel (as shown below). If the resistance is $<10\Omega$, the buzzer goes off continuously; If the resistance is $>50\Omega$, the buzzer does not go off.

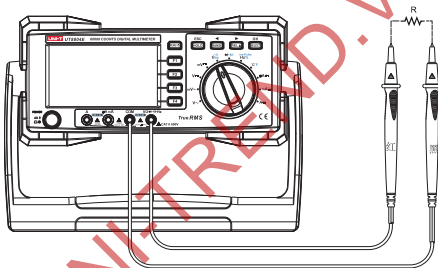

- 3) Read the measured resistance value directly from the display.

⚠ Note:

- Before measuring the resistance online, switch off the power supply of the circuit, and fully discharge all capacitors.
- Do not input voltage higher than AC 30Vrms (peak value 42V) or DC 60V. Otherwise there is a risk of injury to personal safety.
- After finishing all measurement operations, disconnect the test leads from the measured circuit.

11. Capacitance Measurement

- 1) Insert the red test lead into the “ \rightarrow ” jack, black into the “COM” jack.
- 2) Turn the function knob to the $\rightarrow \leftarrow$ position, press the SELECT button to select the capacitance measurement, and then connect the test leads with the capacitor to be measured in parallel (as shown below).

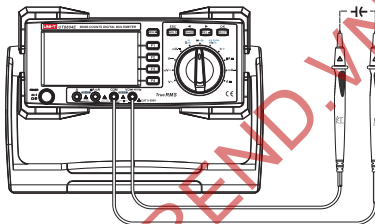

- 3) Read the measured capacitance value directly from the display.

⚠ Note:

- If the measured capacitor is shorted or the capacitance exceeds the maximum range, the “OL” symbol will be displayed on the screen.
- For small capacitance measurement, the REL function should be used to avoid the influence coming from distributed capacitance so as to obtain the correct reading.
- If the measured capacitance is over $600\mu\text{F}$, it will take a long time to obtain the correct reading.
- Before measuring, fully discharge all capacitors (especially for capacitors with high voltage) to avoid damage to the meter and user.
- Do not input voltage higher than AC 30Vrms (peak value 42V) or DC 60V. Otherwise there is a risk of injury to personal safety.
- After finishing all measurement operations, disconnect the test leads from the measured capacitor.

12. Diode Measurement

- 1) Insert the red test lead into the “ \rightarrow ” jack, black into the “COM” jack. The polarity of the red test lead is “+” and that of the black test lead is “-”.
- 2) Turn the function knob to the $\rightarrow \leftarrow$ position, press the SELECT button to select the diode measurement (\rightarrow), and then connect the test leads with the diode to be measured in parallel (as shown below). Read the approximate forward PN junction voltage of the measured diode directly from the display.

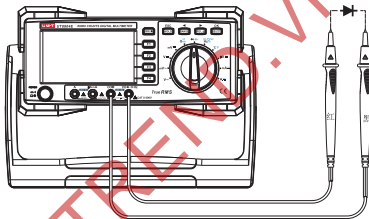

- 3) Short beep indicates the normality of the PN junction; continuous beep indicates the short circuit (less than 0.1V) of the PN junction. The typical voltage of silicon PN junction is about 0.5 to 0.8 V.

⚠ Note:

- If the diode is open or its polarity is reversed, the “OL” symbol will be displayed on the screen.
- Before measuring the diode online, switch off the power supply of the circuit, and fully discharge all capacitors.
- The OCV for diode measurement is about 3V.
- Do not input voltage higher than AC 30Vrms (peak value 42V) or DC 60V. Otherwise there is a risk of injury to personal safety.
- After finishing all measurement operations, disconnect the test leads from the measured circuit.

13. Frequency/Duty Ratio/Pulse Width Measurement

- 1) Insert the red test lead into the “V” jack, black into the “COM” jack.
- 2) Turn the function knob to the $\frac{\text{ms-Pulse}}{\text{Hz\%}}$ position, press the SELECT button to select the frequency (Hz), duty ratio (%) or pulse width (ms-Pulse) measurement, and then connect the test leads with the signal source to be measured in parallel (as shown below).

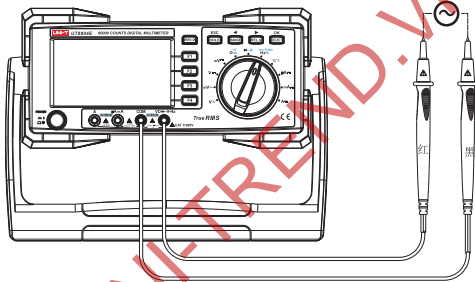

- 3) Read the measured frequency value, duty ratio or pulse width directly from the display.

⚠ Note:

- In the duty ratio and pulse width measurement mode, the simulation bar displays the frequency of the measured signal.
- Do not input voltage higher than AC 30Vrms to avoid injury to personal safety.
- After finishing all measurement operations, disconnect the test leads from the measured circuit.

14. Temperature Measurement

- 1) Turn the function knob to the “°C/°F” position, press the SELECT button to select °C or °F, insert the temperature adapter into the four jacks (as shown below), and then connect the two temperature probes with the adapter to detect the surface of the object to be measured.

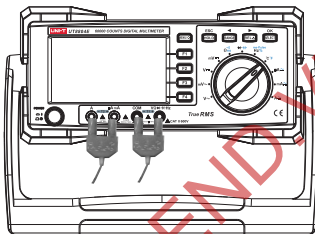

- 2) Read the two measured temperature values (°C or °F) directly from the display.
- 3) Press the MENU button, select the “Measurement” menu, and control the cursor to choose from the following four options:
 - T1, T2: The main display is the temperature value of T1 channel, and the auxiliary display is the temperature value of T2 channel.
 - T2, T1: The main display is the temperature value of T2 channel, and the auxiliary display is the temperature value of T1 channel.
 - T1-T2: The main display is the difference (the temperature value of T1 channel- the temperature value of T2 channel), and the auxiliary display is the temperature values of T1 and T2 channel.
 - T2-T1: The main display is the difference (the temperature value of T2 channel- the temperature value of T1 channel), and the auxiliary display is the temperature values of T1 and T2 channel.The above options need to be confirmed by pressing the F1 button.

⚠ Note:

- The ambient temperature of the meter should not exceed the range of 18-28 °C; otherwise it will cause measurement error, especially in low temperature environment.
- After finishing all measurement operations, remove the temperature probes.
- Point mode K-type thermocouple (only applicable to measuring temperature below 230 °C)

15. Max/Min Value Measurement

After entering the "Statistics" menu, control the cursor to activate the max/min value measurement. The main display is the real-time measured value, and the auxiliary display is the corresponding measurement elapsed time, start date and start time of the max/mean/min value. Press the MENU button, and select the "Reset" menu to restart the max/min value measurement. Press the F4 button to exit the max/min value measurement.

16. Relative Value Measurement

Short press the REL button to enter the relative value measurement mode. At this time, the main display is measured value - base value, while the auxiliary display is relative value and real-time measured value. Long press the REL button to exit the relative value measurement mode.

17. Comparison Mode Measurement

After entering the "Statistics" menu, control the cursor to select the "Comparison Mode" menu to enter the measurement interface of the comparison mode. Before starting the mode, users need to set the following options:

1) Qualified condition

Control the cursor to the Qualified condition column, press the OK button to turn the background blue, and then press the F2 (“◀”) or F3 (“▶”) button to select one of the following four options.

- Internal (>Low Value <High Value)
- External (<Low Value >High Value)
- Greater than (>Value)
- Less than (<Value)

The above settings need to be confirmed by pressing the F1 button. To cancel the setting, press the F4 button.

2) Buzzer sound

Control the cursor to the Buzzer sound column, press the OK button to turn the background blue, and then press the F2 (“◀”) or F3 (“▶”) button to select one of the following three options.

- Pass
This option means that the buzzer sounds when the comparison result is PASS.
- Fail
This option means that the buzzer sounds when the comparison result is FAIL.
- Off
Turn off the buzzer.

The above settings need to be confirmed by pressing the F1 button. To cancel the setting, press the F4 button.

3) Lower limit/Upper limit/Comparison value

Control the cursor to the Lower limit/Upper limit/Comparison value column, press the OK button to turn the background blue, then press the F2 or F3 button to modify the number, and press the “◀” or “▶” button to select the editing position. After setting, press the F1 button to confirm it. To cancel the setting, press the F4 button.

After finishing the above settings, select the “Start” menu to start the comparison mode measurement. Press the F4 button to exit the comparison mode measurement.

18. Measurement Data Recording

Note: During the storage, recording and deletion process, please do not power/turn off the meter at will, otherwise it will easily cause data loss or even damage to the storage space. If the storage space is abnormal, try formatting the memory.

After entering the "Storage" menu, control the cursor to select the following options.

1) Save

Press the F1 button and select the “Save” menu to record the current measurement data once (up to 20,000 records).

2) View save

Control the cursor to select the “View save” menu, and press the F1 or OK button to enter the view interface of the single recorded data. The “” symbol will be displayed at the top right. Press the “◀” button to view the recorded data upwards, and press the “▶” button to view the recorded data downwards. Press the OK button to make the interface of whether to delete the current recorded data pop up. Select the “Yes” menu to delete it, and select the “No” menu to exit the interface. As shown below: in addition to displaying the recorded data, the bottom left corner displays the position and total number of it, and the bottom right corner displays the date and time of it. Press the ESC button to exit.



No.	Description
1	View symbol
2	Recorded data
3	Position and total number of the recorded data
4	Date and time of the recorded data

3) Delete all save

Control the cursor to select the “Delete all save” menu, and press the F1 or OK button to make the interface of whether to delete pop up. Select the “Yes” menu to delete all the recorded data, and select the “No” menu to exit the interface.

4) Record

Control the cursor to select the “Record” menu and press the F1 or OK button to confirm it. Before starting recording, control the cursor to select the following three options.

- Record name

Press the OK button to name the recording item. At this time, the background of the editing position is indicated by blue. Press the “◀” or “▶” button to select the editing position, and press the F1 button to select the “Mode” menu (input mode: uppercase, lowercase, number or symbol). After confirming the mode, press the F2 or F3 button to modify the name. Press the OK button to confirm the naming, while press the F4 button to exit and cancel the current setting.

- Record gap

Press the OK button to set the continuous record gap. At this time, the background of the editing position is indicated by blue. Press the “◀” or “▶” button to select the editing position, and press the F2 or F3 button to enter different numbers. The record gap can be set to 1Sec~60Min. Press the F1 or OK button to confirm the setting, while press the F4 button to exit and cancel the current setting.

- Record duration

Press the OK button to set the continuous record duration. At this time, the background of the editing position is indicated by blue. Press the “◀” or “▶” button to select the editing position, and press the F2 or F3 button to enter different numbers. Duration can be set for days, hours and minutes. The maximum duration is 99 days 23 hours and 59 minutes. Press the F1 or OK button to confirm the setting, while press the F4 button to exit and cancel the current setting.

After finishing the above settings, press the F1 button to select the “Start” menu to start continuous recording. As shown below, the “REC” symbol will be displayed on the screen and the red dot will flash. The related display information is as follows:



No.	Information	Description
1	Main display	Displays real-time input values
2	Number of the data	Total number of the recorded events currently
3	Elapsed time	Displayed in hour: minute: second format
4	Remaining time	Record duration minus elapsed time, displayed in hour: minute: second format
5		
6	Max value	Records the max value of the measured data
7	Mean value	Records the mean value of the measured data
8	Min value	Records the min value of the measured data
9	Record name	Name of the current record
	Start	Start time and date of the recording period

To stop manually, press the OK button to make the interface of whether to stop recording pop up. Select the “Yes” menu by pressing the F2 button to stop recording data, while select the “No” menu by pressing the F4 button to exit the interface and continue recording.

5) View record

Control the cursor to select the “View record” menu, and press the F1 or OK button to enter the view interface. The “” symbol will be displayed at the top right. The relevant basic information is as shown below:

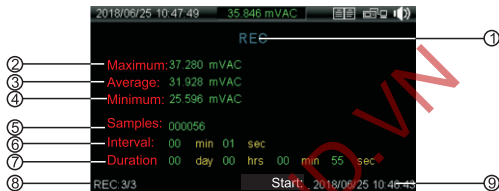

No.	Information	Description
1	Name	Name of the recorded event
2	Max value	Max value of this recorded data
3	Mean value	Mean value of the sum of this recorded data
4	Min value	Min value of this recorded data
5	Number of the data	Total number of this recorded event
6	Record gap	Interval time, displayed in minute: second format
7	Record duration	Actual duration after continuous recording stops
8	REC	Position and total number of this recorded event
9	Start	Start time and date of the recording period

Press the “◀” button to display the basic information of the last recorded event, and press the “▶” button to display the basic information of the next recorded event. Press the ESC button to exit the view interface.

Press the OK button to enter the tendency chart interface of this event. The display information of the tendency chart interface is as shown below:

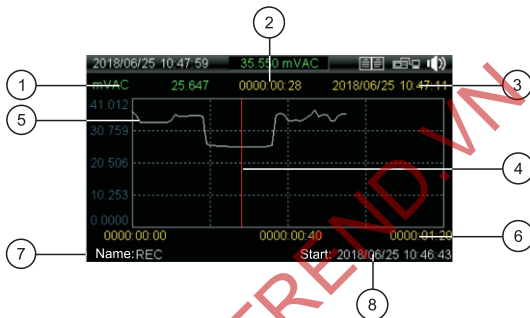

No.	Description
1	Measured value corresponding to the cursor
2	Elapsed time of the measured value corresponding to the cursor
3	Date and time of measurement corresponding to the cursor
4	Cursor
5	Trendline
6	X-axis time stamp, displayed in elapsed time
7	Name of the recorded event
8	Start time and date of the recording period

To view the tendency chart, short press or long press the “◀” button to move the cursor to the left. For each short press, the cursor moves one datum or one pixel to the left. For long press, the cursor accelerates to the left. Short press or long press the “▶” button to move the cursor to the right. For each short press, the cursor moves one datum or one pixel to the right. For long press, the cursor accelerates to the right.

Press the MENU button to make four types of menus (vertical magnification, vertical reduction, horizontal magnification and horizontal reduction) pop up. Press the F1 or F2 button to make the curve chart be zoomed vertically. Press the F3 or F4 button to make the curve chart be zoomed horizontally. Press the MENU button again to exit the menu.

To delete this recorded event, press the OK button in the environment of tendency chart interface to make the interface of whether to delete this recorded event pop up. Select the “Yes” menu to delete this recorded event, while select the “No” menu to exit the interface.

6) Delete all record

Control the cursor to select the “Delete all record” menu, and press the F1 or OK button to make the interface of whether to delete pop up. Select the “Yes” menu to delete all the recorded data, and select the “No” menu to exit the interface.

19. Backlight Control

If the light is not enough to see the display screen, long press the  button for 1 second to switch the backlight brightness.

20. Settings

Select the "Settings" menu to set and view the related information of the meter, and control the cursor to select the related information of the menu item below.

1) Language

Select the "Setup" menu to make a small window pop up, which is indicated by blue background. Press the F2 or F3 button to select a different language, and press the F1 button to confirm the modification. Press the F4 button to exit the small window.

2) Button sound

Select the "On" menu to turn on the button sound, and select the "Off" menu to turn off the button sound.

3) Mis-insertion Alarm for Test Leads

Select the "On" menu to turn on the mis-insertion alarm for test leads, and select the "Off" menu to turn off the mis-insertion alarm for test leads.

4) Communication Transmission

Select the "On" menu to turn on the communication transmission and the  symbol will be displayed at the top left.

Select the "Off" menu to turn off the communication transmission and the  symbol at the top left will be blanked.

5) Time and Date

Select the "Setup" menu to make the time and date editing window pop up. At this time, the background of the editing position is indicated by blue. Press the "◀" or "▶" button to select the editing position, and press the F2 or F3 button to enter different numbers. Press the F1 button to confirm the modification, while press the F4 button to exit the window.

6) Set dBm Reference Value

Select the "Setup" menu, and press the F2 ("◀") or F3 ("▶") button to scroll between the ten defined reference values (4, 8, 16, 25, 32, 50, 75, 600, 1000 and Modify). When selecting the "Modify" menu option, press the F2 or F3 button to modify the number and the "◀" or "▶" button to select the editing position. Any reference impedance value from 4Ω to 1200Ω can be selected. Press the F1 button to confirm the modification.

7) Storage formatting

Select the "Start" menu to make the formatting warning window pop up. Select the "Yes" menu to format the storage, and select the "No" menu to cancel the formatting and exit the window.

8) Factory Reset

Select the "Reset" menu to make the factory reset warning window pop up. Select the "Yes" menu to restore factory settings, and select the "No" menu to cancel the factory reset and exit the window.

9) About the Meter

Select the "About" menu to view the product model, version, serial number and available memory space.

VIII. Technical specifications

Accuracy: \pm (% of reading + digits), 1 year warranty; if the ambient temperature changes by $\pm 5^{\circ}\text{C}$, the accuracy will not be used until 2 hours later.

Ambient temperature: $23^{\circ}\text{C} \pm 5^{\circ}\text{C}$

Ambient humidity: $\leq 75\%$ RH

Temperature coefficient: $0.1 \times$ (specified accuracy)/ $^{\circ}\text{C}$ ($< 18^{\circ}\text{C}$ or $> 28^{\circ}\text{C}$)

1. AC Voltage

Range	Resolution	Accuracy			
		45 ~ 1kHz	1k ~ 10kHz	10k ~ 20kHz	20k ~ 100kHz
60mV	0.001mV	45 ~ 1kHz	1k ~ 10kHz	10k ~ 20kHz	20k ~ 100kHz
		$\pm(0.6\%+60)$	$\pm(1.2\%+60)$	$\pm(3\%+60)$	$\pm(4\%+60)$
600mV	0.01mV	45 ~ 1kHz	1k ~ 10kHz	10k ~ 20kHz	20k ~ 100kHz
		$\pm(0.3\%+30)$	$\pm(1.2\%+40)$	$\pm(3\%+40)$	$\pm(4\%+40)$
6V	0.0001V	45 ~ 1kHz	1k ~ 10kHz	10k ~ 20kHz	20k ~ 100kHz
		$\pm(0.3\%+30)$	$\pm(1.2\%+40)$	$\pm(3\%+40)$	$\pm(4\%+40)$
60V	0.001V	45 ~ 1kHz	1k ~ 10kHz	10k ~ 20kHz	20k ~ 100kHz
		$\pm(0.3\%+30)$	$\pm(1.2\%+40)$	$\pm(3\%+40)$	$\pm(4\%+40)$
600V	0.01V	45 ~ 1kHz	1k ~ 10kHz	10k ~ 20kHz	20k ~ 100kHz
		$\pm(0.4\%+30)$	$\pm(1.2\%+40)$	$\pm(3\%+40)$	For reference only
1000V	0.1V	45 ~ 1kHz	1k ~ 5kHz	5k ~ 10kHz	10k ~ 100kHz
		$\pm(0.6\%+30)$	$\pm(3\%+40)$	$\pm(6\%+40)$	For reference only

- Input impedance: About 10M Ω
- Overload protection: 1000V
- Display: True RMS, applicable to 10% ~ 100% of the range

2. DC Voltage

Range	Resolution	Accuracy
60mV	0.001mV	$\pm(0.025\%+20)$
600mV	0.01mV	$\pm(0.025\%+5)$
6V	0.0001V	
60V	0.001V	
600V	0.01V	$\pm(0.03\%+5)$
1000V	0.1V	

- Input impedance: About 10M Ω
- Overload protection: 1000V
- REL function should be used to compensate the bias for 60mV setting.

3. AC Voltage+ DC Voltage

Range	Resolution	Accuracy		
60mV	0.001mV	50~1kHz	1k~10kHz	10k~35kHz
		$\pm(1\%+80)$	$\pm(3\%+40)$	$\pm(6\%+40)$
600mV	0.01mV	50~1kHz	1k~10kHz	10k~35kHz
		$\pm(1\%+80)$	$\pm(3\%+40)$	$\pm(6\%+40)$
6V	0.0001V	50~1kHz	1k~10kHz	10k~35kHz
		$\pm(1\%+80)$	$\pm(3\%+40)$	$\pm(6\%+40)$
60V	0.001V	50~1kHz	1k~10kHz	10k~35kHz
		$\pm(1\%+80)$	$\pm(3\%+40)$	$\pm(6\%+40)$
600V	0.01V	50~1kHz	1k~10kHz	10k~35kHz
		$\pm(1\%+80)$	For reference only	For reference only
1000V	0.1V	50~1kHz	1k~10kHz	10k~35kHz
		$\pm(1.2\%+80)$	For reference only	For reference only

- Input impedance: About 10M Ω
- Overload protection: 1000V
- Display: True RMS, applicable to 10% ~100% of the range

4. AC

Range	Resolution	Accuracy	
		45~1kHz	1k~10kHz
600μA	0.01μA	±(0.6%+40)	±(1.2%+40)
		45~1kHz	1k~10kHz
6000μA	0.1μA	±(0.6%+20)	±(1.2%+40)
		45~1kHz	1k~10kHz
60mA	0.001mA	±(0.6%+40)	±(1.2%+40)
		45~1kHz	1k~10kHz
600mA	0.01mA	±(0.6%+20)	±(1.2%+40)
		45~1kHz	1k~10kHz
10A	0.001A	±(1%+20)	±(3%+40)
		45~1kHz	1k~10kHz

- Display: True RMS, applicable to 10% ~100% of the range
- Overload protection:
 μA, mA range: 0.6A H 1000V fast-acting fuse (Φ6x32mm)
 10A range: 11A H 1000V fast-acting fuse (Φ10x38mm)
- When the measured current is close to 20A, each measurement time should be less than 30s and the rest interval should be more than 10 minutes!

5. DC

Range	Resolution	Accuracy
600 μ A	0.01 μ A	$\pm(0.08\%+20)$
6000 μ A	0.1 μ A	$\pm(0.08\%+10)$
60mA	0.001mA	$\pm(0.08\%+20)$
600mA	0.01mA	$\pm(0.15\%+10)$
10A	0.001A	$\pm(0.5\%+10)$

- Overload protection:
 μ A, mA range: 0.6A H 1000V fast-acting fuse (Φ 6x32mm)
 10A range: 11A H 1000V fast-acting fuse (Φ 10x38mm)
- When the measured current is close to 20A, each measurement time should be less than 30s and the rest interval should be more than 10 minutes!

6. AC+DC

Range	Resolution	Accuracy	
		50~1kHz	1k~10kHz
600μA	0.01μA	±(0.8%+40)	±(2.0%+40)
		50~1kHz	1k~10kHz
6000μA	0.1μA	±(0.8%+20)	±(2.0%+40)
		50~1kHz	1k~10kHz
60mA	0.001mA	±(0.8%+40)	±(2.0%+40)
		50~1kHz	1k~10kHz
600mA	0.01mA	±(0.8%+20)	±(2.0%+40)
		50~1kHz	1k~10kHz
10A	0.001A	±(1.2%+20)	±(3%+40)
		50~1kHz	1k~10kHz

- Display: True RMS, applicable to 10% ~100% of the range
- Overload protection:
 μA, mA range: 0.6A H 1000V fast-acting fuse (Φ6x32mm)
 10A range: 11A H 1000V fast-acting fuse (Φ10x38mm)
- When the measured current is close to 20A, each measurement time should be less than 30s and the rest interval should be more than 10 minutes!

7. Resistance

Range	Resolution	Accuracy
600Ω	0.01Ω	In the REL state: $\pm(0.05\%+10)$
6kΩ	0.0001kΩ	$\pm(0.05\%+2)$
60kΩ	0.001kΩ	
600kΩ	0.01kΩ	
6MΩ	0.0001MΩ	$\pm(0.3\%+10)$
60MΩ	0.001MΩ	$\pm(2\%+10)$

- Overload protection: 1000V
- The humidity should be <50% for 60MΩ setting.

8. Conductance

Range	Resolution	Accuracy
60nS	0.01nS	$\pm(2\%+10)$

- Overload protection: 1000V
- The humidity should be <50%.

9. Capacitance

Range	Resolution	Accuracy
6nF	0.001 nF	$\pm(3\%+10)$
60nF	0.01nF	$\pm(2.5\%+5)$
600nF	0.1nF	$\pm(2\%+5)$
6 μ F	0.001 μ F	
60 μ F	0.01 μ F	
600 μ F	0.1 μ F	
6mF	1 μ F	$\pm(5\%+5)$
60mF	10 μ F	Not specified

- Overload protection: 1000V
- Display: 6000 count

10. Temperature

Range	Resolution	Accuracy
-40°C~40°C	1°C	$\pm(2.0\%+30)$
40°C~400°C		$\pm(1.0\%+30)$
100°C~1000°C		$\pm 2.5\%$
-40°F~104°F	1°F	$\pm(2.5\%+50)$
104°F~752°F		$\pm(1.5\%+50)$
752°F~1832°F		$\pm 2.5\%$

- Overload protection: 1000V
- Dual channel temperature measurement
- Temperature sensor: Point mode K-type thermocouple (only applicable to measuring temperature below 230 °C)

11. Frequency

Range	Resolution	Accuracy
60Hz	0.001 Hz	$\pm(0.02\%+8)$
600Hz	0.01 Hz	$\pm(0.01\%+5)$
6kHz	0.0001kHz	
60kHz	0.001kHz	
600kHz	0.01kHz	
6MHz	0.0001MHz	
60MHz	0.001MHz	

- Overload protection: 1000V
- Input amplitude requirements:
 10Hz~30MHz: $600\text{mV} \leq a \leq 30\text{V}_{\text{m}}$
 >30MHz: Not specified

12. Duty Ratio

Range	Resolution	Accuracy
10%~90% (10Hz~2kHz)	0.01	$\pm(1.2\%+30)$

- Overload protection: 1000V
- Rise time: < 1 μ s, the signal is centered on the triggering level.

13. Pulse Width

Range	Resolution	Accuracy
250m	S0.001mS~0.01mS	±(1.2%+30)

- Overload protection: 1000V
- Rise time: < 1 μ s, the signal is centered on the triggering level.
- 10 Hz~200 kHz: Pulse width > 2 μ s

The pulse width range is determined by the frequency of the signal.

14. Continuity Measurement

Range	Resolution	Remark
	0.01 Ω	The OCV is about 3V; Short circuit alarm: If the resistance is <10 Ω , the buzzer goes off continuously; If the resistance is >50 Ω , the buzzer does not go off. Open circuit alarm: If the resistance is >50 Ω , the buzzer goes off continuously; If the resistance is <10 Ω , the buzzer does not go off.

- Overload protection: 1000V

15. Diode Measurement

Range	Resolution	Remark
	0.0001V	The OCV is about 3V and the measurable forward voltage drop value of the PN junction is about \leq 3V. When the buzzer is activated, short beep indicates the normality of the PN junction; continuous beep indicates the short circuit of the PN junction. The typical voltage of silicon PN junction is about 0.5 to 0.8 V.

- Overload protection: 1000V

IX. Maintenance

1. General Maintenance

Clean the meter casing with a damp cloth and mild detergent regularly. Do not use abrasives, isopropyl alcohol or solvents. Dirt or moisture on the terminals will affect the readings and incorrectly activate the mis-insertion alarm. Please follow the steps below to clean the terminals:

- 1) Turn off the meter and remove all test leads.
- 2) Remove the dirt from the terminals.
- 3) Soak a clean cotton swab with mild detergent and water. Clean each terminal with the swab and dry it with canned compressed air to force the detergent and water out of the terminal.
- 4) If there is any malfunction, stop using the meter and send it for maintenance.
- 5) The calibration and maintenance must be implemented by qualified professionals or designated departments.

2. Power supply setting

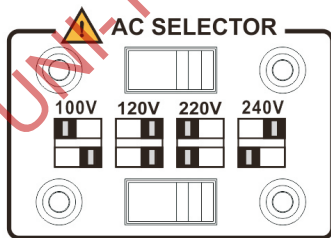

- 1) Flick the red selector to the corresponding position.
- 2) Four options (100V/120V/220V/240V) can be set.

3. Fuse replacement

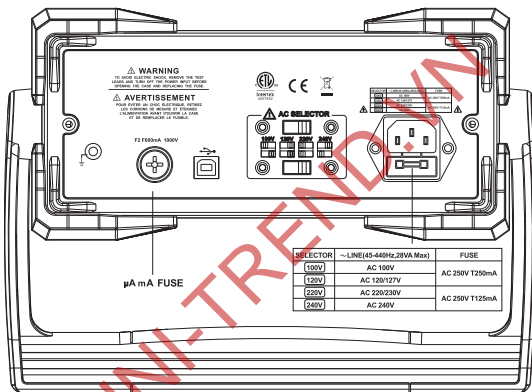

- 1) Switch off the power supply.
- 2) Open the fuse housing with a flathead screwdriver.
- 3) Replace the fuse with new one.

The contents of this manual are subject to change without notice.

UNI-TREND.VN

UNI-T®

UNI-TREND TECHNOLOGY (CHINA) CO., LTD.

No6, Gong Ye Bei 1st Road,
Songshan Lake National High-Tech Industrial
Development Zone, Dongguan City,
Guangdong Province, China
Tel: (86-769) 8572 3888
<http://www.uni-trend.com>

