

# UT501E

## Fast Insulation Resistance Tester

### User Manual



## Preface

Thank you for purchasing this brand new product. In order to use this product safely and correctly, please read this manual thoroughly, especially the Safety Instructions part.

After reading this manual, it is recommended to keep the manual at an easily accessible place, preferably close to the device, for future reference.

## Limited Warranty and Liability

Uni-Trend guarantees that the product is free from any defect in material and workmanship within one year from the purchase date. This warranty does not apply to damages caused by accident, negligence, misuse, modification, contamination or improper handling. The dealer shall not be entitled to give any other warranty on behalf of Uni-Trend. If you need warranty service within the warranty period, please contact your seller directly.

Uni-Trend will not be responsible for any special, incidental or subsequent damage or loss caused by using the device.

UNI-TREND.VN

## Contents

1. Overview.....	1
2. Functions.....	1
3. Technical Specifications.....	2
3.1 Specifications for Insulation Resistance Test.....	2
3.2 Specifications for AC/DC Voltage Test.....	3
3.3 Specifications for Low Resistance Test.....	3
3.4 Other Specifications.....	4
4. Accessories.....	5
5. Safety Information.....	5
6. Electrical Symbols.....	6
7. External Structure.....	7
8. Button Descriptions.....	8
9. LCD Display.....	9
10. Button Functions.....	10
11. Operate the Tester.....	12
12. Battery Charging.....	14
13. Basic Measurements.....	15
13.1 Insulation Resistance Measurement.....	15
13.2 Continuous Measurement.....	16
13.3 Time-Set Measurement.....	17
13.4 Comparative Measurement.....	18
13.5 Voltage Measurement.....	20
13.6 Low Resistance Measurement.....	22
13.7 Save/Delete Data.....	24
13.8 USB and Bluetooth communications.....	26
14. Bluetooth and USB communications.....	28
15. Maintenance.....	29

## 1. Overview

UT501E is Fast Insulation Resistance Tester (UT500 series) has such core functions as fast insulation resistance measurement, low resistance measurement, automatic AC/DC voltage identification, and more. It also has multiple auxiliary functions including automatic discharge, automatic PI and DAR, time-set measurement, comparative measurement, Bluetooth and USB communications, remote-controlled test, etc.

The Tester is suitable for fast insulation resistance measurement of electrical equipment or materials such as component, switch, appliance, and others. UT501E is an ideal tool for insulation test and calibration of various electrical equipment on production.

## 2. Functions

1. Fast insulation resistance measurement (Output voltage: 100V, 125V, 250V, 500V, 1000V; Short-circuit current: <2mA)
2. AC/DC voltage measurement (Identify AC/DC voltage automatically; Measurement range: 30.0V~600V)
3. Low resistance measurement (Open-circuit voltage: >5V approx.; Current: max. 200mA approx.; Measurement range: 0.00Ω~400Ω)
4. Maximum insulation resistance range: 4000MΩ
5. Manual backlight (Long press the down arrow button to turn on/off the backlight)
6. Automatic discharge (The Tester will automatically discharge the high voltage to ensure safety when the insulation resistance measurement is stopped)
7. Automatic DAR and PI (Automatic operation of the measurement result is performed when continuous insulation resistance measurement is performed and the time is satisfied. The displayed value is switched manually)
8. Time-set measurement (The time is set manually. When the test is started, the set time starts countdown)
9. Comparative measurement (The comparative value is set manually. The comparative result is displayed as "PASS" and "FAIL")
10. Audible and visual alarm (The buzzer alarms and the red warning light is turned on when the insulation resistance measurement is started)
11. Remote-controlled test lead measurement (Press the button at the remote-controlled test lead to start or stop the insulation resistance test or low resistance test)
12. Zeroing adjustment (For low resistance measurement, short the test lead and short press the "Zero" button to clear the residual reading; short press again to exit the zeroing mode)
13. Overrange indication (For high or low resistance measurement: "> maximum value" is displayed. For voltage measurement: "OL V/-OL V" is displayed)
14. Voltage detection (If a voltage of >about 30V is present at the insulation testing terminal, the buzzer alarms and the measurement is forbidden)

15. Low resistance alarm (The buzzer sounds continuously if the insulation resistance is  $<4\text{M}\Omega$  or the low resistance is  $<20\Omega$ )
16. Data hold (Hold the data automatically when the insulation resistance test or low resistance test is stopped)
17. Data storage (Short press the “Save” button to the present data. Maximum 99 sets of data can be saved)
18. Analog bar graph (The analog bar graph indicates measurement range when the insulation resistance measurement is performed)
19. Displaying battery power (The battery power indicator shows the remaining power)
20. Auto power off (The Tester powers off automatically in 10 min of inactivity)
21. Bluetooth APP and USB: Long press the “▲” button to start uploading the USB data, long press the up “▲” again (with the symbol “USB” blinking), and long press the “OK” button to upload all storage data, then the USB symbol stops flashing when the data upload is completed. After that, long press the “▲” button to start the Bluetooth communication, and long press the “▲” button again to start uploading the USB data and Bluetooth communication at the same time, then long press the “▲” button again to exit uploading USB data and Bluetooth communication mode.
22. Safety lock (The “TEST” button can be rotated and locked in insulation resistance measurement or low resistance measurement mode)
23. High-definition segmented LCD
24. Power supply: Li-ion battery (11.1V/2600mAh)
25. Charging adapter (12.6V/0.8A@10.0W)

### 3. Technical Specifications

- Error limit:  $\pm(a\%$  of reading + b digits); one-year warranty
- Ambient temperature:  $23\pm 5^\circ\text{C}$
- Ambient humidity: 45~75%RH
- External electric field: No electric field (Earth magnetic field)
- Battery voltage: Effective range of battery
- Temperature coefficient: For tests out of specified temperature range (i.e.,  $>28^\circ\text{C}$  or  $18^\circ\text{C}$ ), the testing error is increased by  $\pm 0.25\%$  per degree Celsius.

#### 3.1 Specifications for Insulation Resistance Test

Voltage rating	100V	125V	250V	500V	1000V
Measurement range	0.10M $\Omega$ ~4000M $\Omega$ (The buzzer alarms if the resistance is less than about 4.00M $\Omega$ )				
Open-circuit voltage	100V~110V	125V~138V	250V~275V	500V~550V	1kV~1.1kV
Nominal current	1.0~1.1mA @100K $\Omega$	1.0~1.1mA @125K $\Omega$	1.0~1.1mA @250K $\Omega$	1.0~1.1mA @500K $\Omega$	1.0~1.1mA @1M $\Omega$
Short-circuit	Less than 2mA approx.				

current				
Accuracy	0.10~20.0MΩ ±(2%+6)	0.20~40.0MΩ ±(2%+6)	0.50~200MΩ ±(2%+6)	1.00~1000MΩ ±(2%+6)
	20.1~200MΩ ±(5%+6)	40.1~500MΩ ±(5%+6)	201~2000MΩ ±(5%+6)	1001~4000MΩ ±(5%+6)
Resolution	0.01MΩ (0.10~9.99 MΩ) 0.1 MΩ (10.0~99.9 MΩ) 1 MΩ (100~4000 MΩ)			

- 1MΩ (Mega ohm) = 1000KΩ = 10<sup>6</sup> Ω
- Overrange indication: "> Maximum value" is displayed.
- Note: For insulation resistance measurement, a large offset value may occurs if the measured capacitive reactance is greater than about 100nF.

### 3.2 Specifications for AC/DC Voltage Test

AC voltage	Measurement range	30.0~600V (50Hz/60Hz)
	Resolution	0.1V (30.0~99.9V); 1V (100~600V)
	Accuracy	±(2%+3)
DC voltage	Measurement range	±(30.0~600V)
	Resolution	0.1V (30.0~99.9V); 1V (100~600V)
	Accuracy	±(2%+3)
Overrange indication	"OL V" or "-OL V" is displayed	

### 3.3 Specifications for Low Resistance Test

Measurement range	0.01Ω~400Ω (The buzzer alarms if the resistance is less than about 20.0Ω)
Resolution	0.01Ω (0.01~9.99Ω); 0.1Ω (10.0~99.9Ω); 1Ω (100~400Ω)
Testing current	>200mA
Accuracy	±(2%+8)
Overrange indication	">420Ω" is displayed

### 3.4 Other Specifications

Power supply	Rechargeable lithium battery (11.1V/2600mAh)
Charging adapter	12.6V/0.8A@10.0W
Insulation output voltage	100V, 125V, 250V, 500V, 1000V
Output voltage accuracy	+ (0%~10%)
Insulation resistance measurement range	0.10MΩ~4000MΩ
Short-circuit current	<2mA
Continuous measurement	√ (Default measurement mode)
Time-set measurement	√
Comparative measurement	√
Remote-controlled measurement	√
Automatic AC/DC voltage identification	√
External voltage detection	√ (If a voltage of >about 30V is present at the insulation measurement terminal, the buzzer alarms and the measurement is forbidden.)
Measurement time recording	√
High voltage warning	If the safety voltage is exceeded, the high voltage warning symbol will appear.
Automatic discharge	√
Manual backlight	√
Data storage function	√ (Maximum 99 sets of data can be saved)
Communication function	Upload the data to PC via USB cable (Unidirectional)
	Communicate with APP via Bluetooth (Bidirectional)
Displaying battery power	√ (Displaying remaining battery power and indicating low battery power)
Auto power off	√ (The Tester powers off automatically in 10 min of inactivity)
Dimensions	158mm (L) × 105mm (W) × 71mm (D)
Weight	0.5KG (including battery)
Supplied test leads	Remote-controlled test lead: 1 pc Red test lead: 1 pc Black test lead: 1 pc

	Alligator clip: 2 pcs Pen-shaped test probe: 2 pcs
Operating altitude	≤2000m (Indoor use)
Drop proof	1 m (without the testing function being affected)
IP rating	IP54 (Overall protection with cover closed)
Pollution degree	Class II
Operating environment	0°C~35°C; <75%RH (No condensation)
Storage environment	-20°C~60°C; <80%RH (No condensation)

## 4. Accessories

Please carefully check if any accessory below is missing or damaged.

1. User manual: 1 pc
2. Warranty certificate/Quality certificate: 1 pc
3. Test lead (Red, black, and remote-controlled leads): 3 pcs in total
4. Alligator clip: 2 pcs
5. Pen-shaped test probe: 2 pcs
6. Type-C USB cable: 1 pc
7. Lithium battery charger (Model: XZF-A1260800-H; Specification: 12.6V/0.8A): 1 pc
8. Lithium battery pack (Embedded in the Tester. Model: UT-M19; Specification: 11.1V/2600mAh): 1 pc
9. Charging adapter (Optional; Model: UT-W13)
10. Lanyard 1pc

Please contact your local distributor if any accessory is missing or damaged.

## 5. Safety Information

The Tester is designed, manufactured and calibrated in accordance with IEC 61010 Safety Standard (Safety Requirements of Electronic Products) and Double Insulation. To avoid electric shock or personal injury, please carefully read the safety information and precautions in the User Manual before first use.





### Warning

- Please keep the User Manual with you for reference at any time.
- Use the Tester according to the operating instructions.
- Wear insulating gloves before use.
- Do not perform measurement in circuit of over 600VAC or 600VDC.
- Do not test in environments with flammable and explosive substances. Spark can cause explosion!
- Do not use if the surface of the Tester or the operator's hands are wet.



- For voltage test, please pay attention to avoid shorting the metal part with test leads, otherwise it may cause personal injury.
- Do not exceed the maximum range during measurement.
- Do not press the “TEST” button before connecting the test leads.
- Do not open the battery during measurement.
- Do not touch the measured circuit during or after insulation resistance test, otherwise it may cause electric shock.
- If any dirt or carbide, which can degrade the insulation performance, occurs at the test leads or terminals, please stop test immediately.
- Do not short or connect the test leads during insulation resistance test, as incorrect operation may cause the test to be interrupted or damage the Tester or the measured object. The top end of the test lead will produce electrical discharge when the test lead is shorted or connected, please note that appropriate electrical discharge may deteriorate the product performance
- Please check the Tester and test leads before use to prevent any damage or other problems. Stop using the Tester if the test leads and the insulation of the Tester case are damaged, the LCD cannot display anything, or the Tester is perceived as malfunctioned.
- It is forbidden to use the Tester without the battery cover closed in place, otherwise it may produce a risk of electric shock.
- Please grip the test lead behind the finger guard during measurement. To avoid electric shock, please do not contact bare electric wire, connector, alligator clip, etc.
- Please set the rotary switch to correct position. Do not turn the rotary switch during measurement to avoid damage to the Tester.
- If the symbol “” is displayed on the LCD, please charge or replace the battery to ensure measurement accuracy. Remove the battery if the Tester is not used for a long time. Please power off the Tester before opening the battery cover.
- Do not alter the internal wiring of the Tester.
- Do not use or keep the Tester in environments with high temperature and humidity, explosive and flammable substances, or strong electromagnetic fields
- Please clean the Tester case with damp cloth and mild detergent. Do not use abrasives or solvents.

## 6. Electrical Symbols

	Risk of electric shock!
	Direct Current
	Alternating Current
	Caution or warning
	Battery power

## 7. External Structure

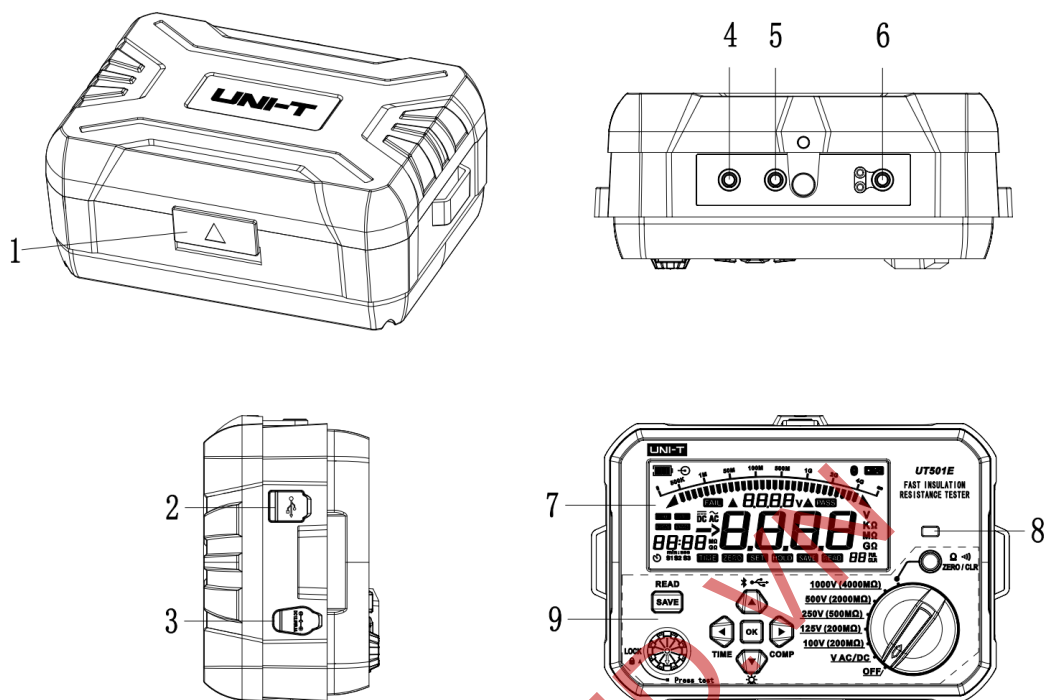

7.1 External structure

1	Opening of flap over of protective cover
2	USB: Type-C USB data transmission port
3	Lithium battery charging port (12.6V/0.8A)
4	$\Omega$ /Continuity: Low resistance (continuity) measurement terminal (single-ended red lead)
5	COM terminal: High/low resistance and voltage measurement terminal (single-ended black lead)
6	Insulation/V: High resistance and voltage measurement terminal (single-ended red lead and remote-controlled test)
7	High-definition segmented LCD
8	Red warning light (indication of insulation measurement or overvoltage)
9	Functional buttons and rotary switch positions

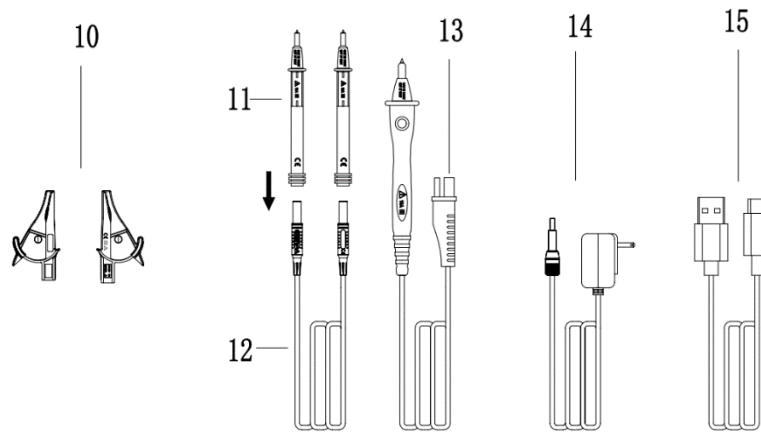

Figure 7.2 Auxiliary clips, probes, leads, charger and USB cable

10	Alligator clips (red, black)
11	Pen-shaped test probe
12	Red and black test leads (silicone)
13	Remote-controlled test lead (with “TEST” button on it)
14	Dedicated lithium battery charger
15	USB Type-C cable (for communication with PC)

## 8. Button Descriptions

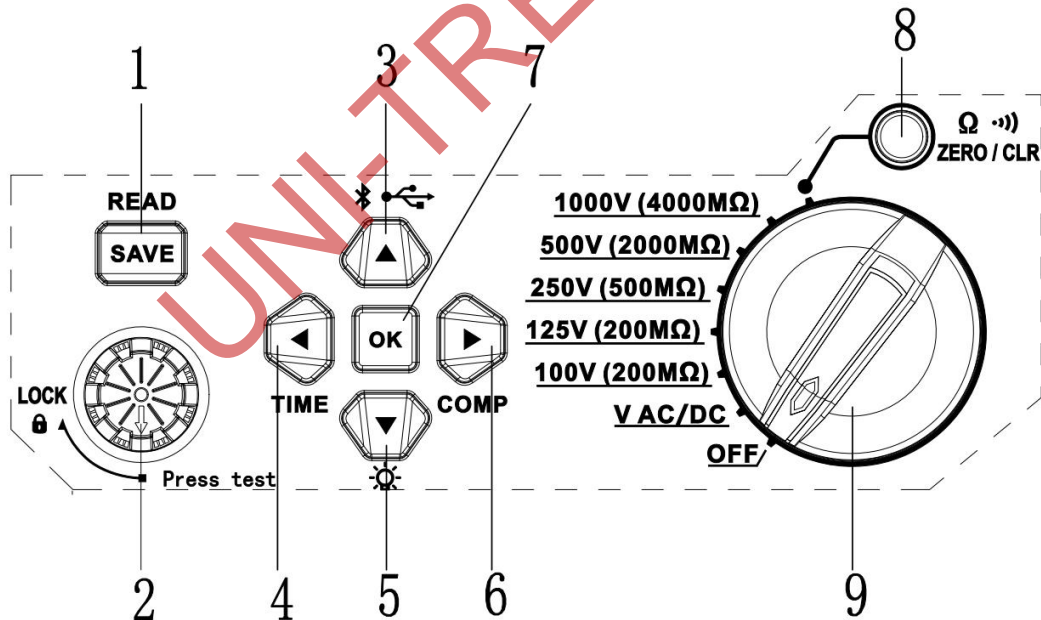

Figure 8.1 Functional buttons and rotary switch positions

1	Save/Read button
2	TEST button (Press to test; turn to lock)
3	Up arrow button; Turn on/off Bluetooth and USB

4	Left arrow button; Enter/Exit time-set measurement
5	Down arrow button; Turn on/off the backlight
6	Right arrow button; Enter/Exit comparative
7	OK button (Confirm the set value and deletion)
8	Zero residual reading; Clear data; Turn on/off the buzzer warning
9	OFF: Power off the Tester
	VAC/DC: AC/DC voltage test
	100V (200MΩ): 100V insulation resistance test
	125V (200MΩ): 125V insulation resistance test
	250V (500MΩ): 250V insulation resistance test
	500V (2000MΩ): 500V insulation resistance test
	1000V (4000MΩ): 1KV insulation resistance test
Ω: Low resistance test (Continuity measurement)	

### 9. LCD Display

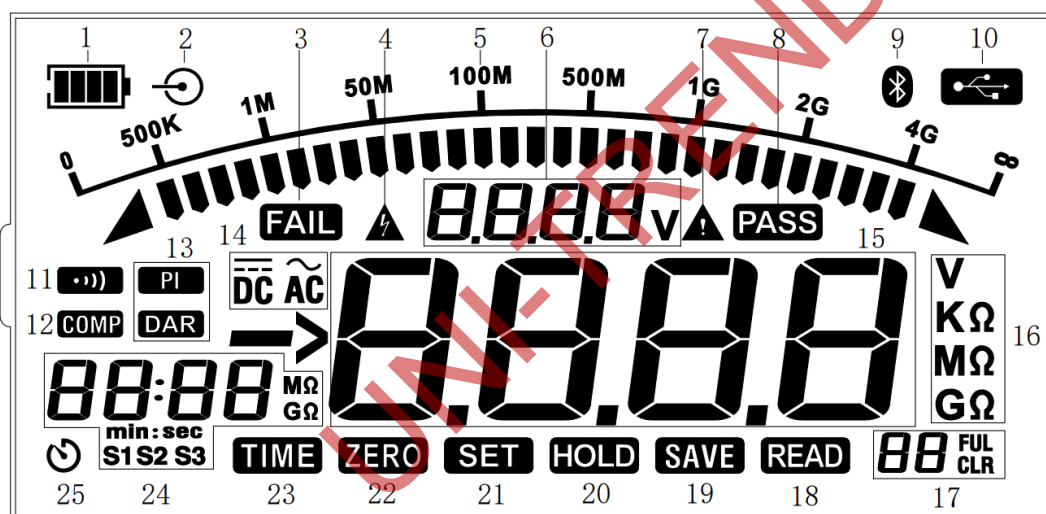

Figure 9.1 All segments are displayed on the LCD

1	Battery power symbol (Remaining battery power is displayed when the Tester is turned on)
2	Charger symbol (This symbol is displayed the charger is connected)
3	Comparative measurement is FAIL (The measured value is less than the set value).
4	This symbol appears when external voltage or high voltage is
5	Analog bar graph (Insulation resistance measurement; Displaying resistance range)
6	Voltage at the selected position, output voltage in real time, DAR,

7	Dangerous operation (This symbol appears when external voltage is detected)
8	Comparative measurement is PASS (The measured value is greater than or equal to the set value).
9	Bluetooth symbol (Bluetooth communication is started)
10	USB symbol (USB communication is started)
11	Buzzer alarm symbol (Buzzer alarm is started)
12	Comparative measurement symbol (Enter the comparative measurement mode)
13	DAR and PI symbols (Automatic operation of measurement result; result reading)
14	Alternating/Direct current symbol ("AC" is displayed for alternating current and "DC" for direct)
15	Measured value (Insulation resistance, low resistance, and voltage)
16	Measurement units (Resistance and voltage units)
17	Number of groups of saved data (or the group No.)
18	Read data (This symbol appears in data reading mode)
19	Save data (This symbol flashes once every time one group of data)
20	Hold the interface automatically (The interface is held and this symbol appears when the measurement is completed)
21	Setting symbol (This symbol is displayed when entering the value setting mode)
22	Zeroing symbol (It appears when performing low resistance measurement and zeroing operation)
23	Time-set measurement symbol (This symbol appears when entering the time-set measurement mode)
24	Time setting; Comparative value setting; Displaying continuous time
25	Time-set shutdown symbol (It appears when the Tester is turned on)

## 10. Button Functions

### • OFF Position

Set the rotary switch to any positions other than "OFF" to power on the Tester. Set the rotary switch to "OFF" to power off the Tester. The Tester powers off automatically in 10 minutes of inactivity.

### • Fast Insulation Resistance Measurement Position

Set the rotary switch to 100V (200M $\Omega$ ), 125V (200M $\Omega$ ), 250V (500M $\Omega$ ), 500V (2000M $\Omega$ ), or 1000V (4000M $\Omega$ ) position to enter the continuous insulation resistance measurement mode at corresponding position.

### • AC/DC Voltage Measurement Position

Set the rotary switch to V AC/DC position to enter the AC/DC voltage measurement mode. At this

position, the Tester can automatically measure and identify the AC/DC voltage and polarity.

- **Low Resistance Position**

Set the rotary switch to “Ω” position to enter the low resistance measurement (continuity measurement) mode.

- **SAVE/READ Button**

When short pressing this button, the present data is saved, the symbol “SAVE” blinks once, and the number of groups of saved data is displayed (maximum 99 groups of data can be saved). If the number of groups of saved data are full, then the number of groups will be displayed as “99” (with the symbol “FULL” displayed).

When long pressing this button, the Tester enters the data reading mode, and the symbol “READ” and the corresponding group No. of saved data will be displayed.

- **TEST Button**

In insulation resistance measurement mode or low resistance measurement mode, press this button to start test or turn it to lock. This button is disabled when performing external voltage detection, AC/DC voltage measurement or Bluetooth connection or if abnormal situation occurs.

- **Up Arrow Button (▲)**

Short press: In data reading mode, short press this button to read the next group of saved data. In time-set or comparative measurement mode, short press to increase by 1 for the corresponding digit place when setting the time value or comparative value manually.

Long press: In power-on state, long press this button in any mode to start Bluetooth communication and uploading USB data.

- **Down Arrow Button (▼)**

Short press: In data reading mode, short press this button to read the previous group of saved data. In time-set and or comparative measurement mode, short press to decrease by 1 for the corresponding digit place when setting the time value or comparative value manually.

Long press: In power-on state, long press this button in any mode to turn on/off the backlight.

- **Left Arrow Button (◀)**

In insulation resistance measurement mode: When entering time-set or comparative measurement and setting time value or comparative value, short press this button to switch the digit place leftwards.

In insulation resistance measurement mode, long press this button to enter time-set measurement (with the symbols “TIME” and “SET” and the default time “10:00” displayed, to indicate the Tester is in time setting state). Press the OK button when the time is set. Please perform time-set measurement after the symbol “SET” is closed. Long press again to exit time-set measurement and save the set time.

### ● Right Arrow Button (▶)

In insulation resistance measurement mode: When entering time-set or comparative measurement and setting time value or comparative value, short press this button to switch the digit place rightwards.

In insulation resistance measurement mode, long press this button to enter comparative measurement (with the symbols “COMP” and “SET” and the default time “10:00” displayed, to indicate the Tester is in comparative value setting state). Press the OK button when the comparative value is set. Please perform comparative measurement after the symbol “SET” is closed. Long press again to exit comparative measurement and save the comparative value.

### ● OK Button

1. In insulation resistance measurement mode: When entering time-set or comparative measurement, short press the OK button to confirm the final set value or enter the data setting state again.
2. In “one-button” USB upload mode, long press the OK button to upload all saved data.
3. To delete a group of data or all data in the data reading mode, please short press the OK button to complete the data deletion.

Note:

- 1) Short press: <0.5 s; Long press: >1 s
- 2) The Tester beeps twice to indicate the button is disabled and once to enabled.

## 11. Operate the Tester

(1) Open the protective cover, set the rotary switch to any position other than “OFF” (with all segments displayed and the backlight on), then (1 s later) the Tester enters the mode selected by the rotary switch and the backlight turns off automatically 5 seconds later. Please check if the Tester powers on normally and if any segment is missing. In case the Tester is faulty, please get technical support to solve the fault.

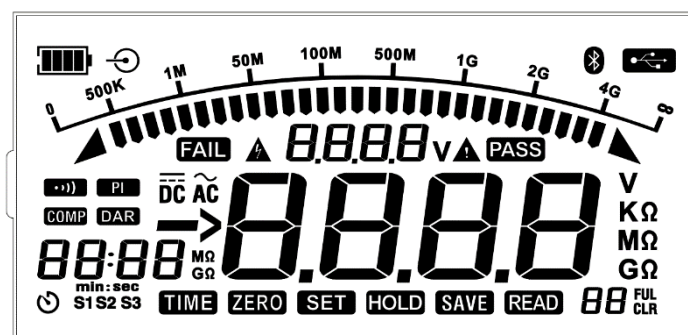



Figure 11.1 All segments are displayed on the LCD

(2) If the symbol “” appears and blinks, then the battery power is almost used up, please charge or replace the battery in time. Do not measure insulation resistance and low resistance if the symbol

“” is displayed on the LCD, as shown in Figures 11.2 and 11.3.

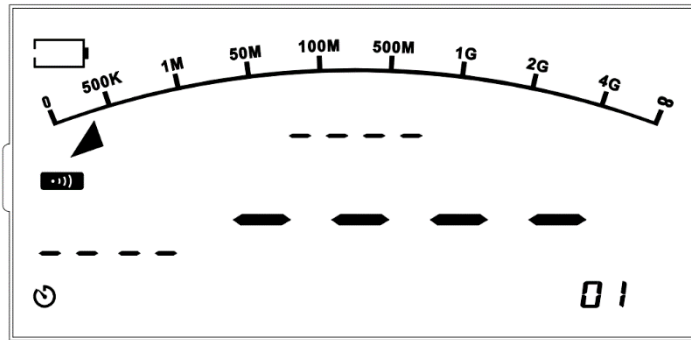

Figure 11.2 Insulation resistance measurement is forbidden

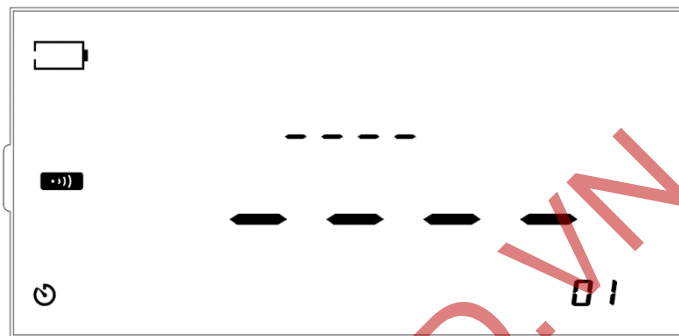







Figure 11.3 Low resistance measurement is forbidden

Power identifier and voltage mapping table : (the segmented critical point voltage has about 5% accuracy error)

Battery	Battery voltage
	<9.9V (Blink at 2 Hz and then power off in 3
	9.9~10.4V
	10.4~11.0V
	11.0~11.5V
	>11.5V

**Note:** Do not perform measurement when the Tester is charged, otherwise all measurement functions will be turned off.

(3) If the test lead is damaged, broken, streaked or cracked, please stop use and contact your distributor or purchase new test leads from nearby franchised stores

(4) If the test leads are not damaged, connect the black test lead to the COM terminal, then connect the red test lead or remote-controlled test rod to the Insulation/V terminal.

(5) Connect the alligator clip or pen-shaped testing probe to the same-color test leads (connect according to corresponding color).

(6) For insulation resistance measurement, short the red and black test leads, then press the TEST button to measure if the internal resistance of the test lead is about 0 MΩ (as shown in Figure 11.4). If the measurement result is far greater than 0 MΩ, please check again if the test lead is connected



to the terminal correctly and if the test lead is damaged internally.

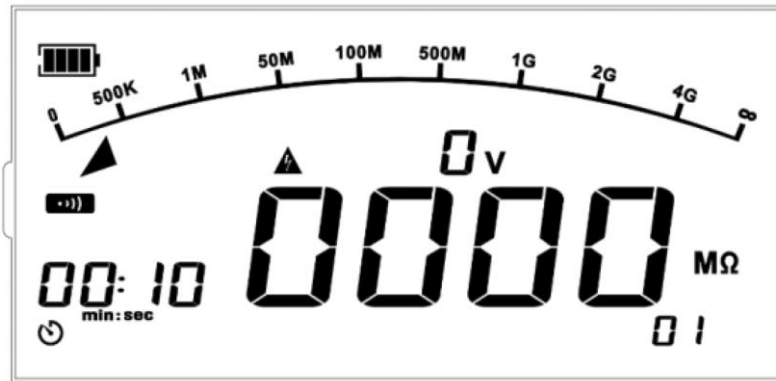







Figure 11.4 Test lead shorted

## 12. Battery Charging

The Tester is embedded with a rechargeable lithium battery pack (11.1V, 2600mAh), please charge the Tester with the supplied dedicated lithium battery charger (12.6V, 0.8A), as shown in Figure 12.1. Alternatively, remove the lithium battery pack and charge it with the UT-W13 Charging Stand (optional), as shown in Figure 12.2.

When charging the Tester in power-on state, the battery power symbols (“”, “”, “” and “”) are shown cyclically. The symbol “” is displayed when fully charged) and the charging indicator will appear on the LCD. When charging the battery pack with the charging stand, the charging indicator will light up (In red: charging; In green: fully charged; In red and green alternately: critical state).

**Note:** To check if the battery is fully charged, please power on the Tester and then observe the charging indicator.

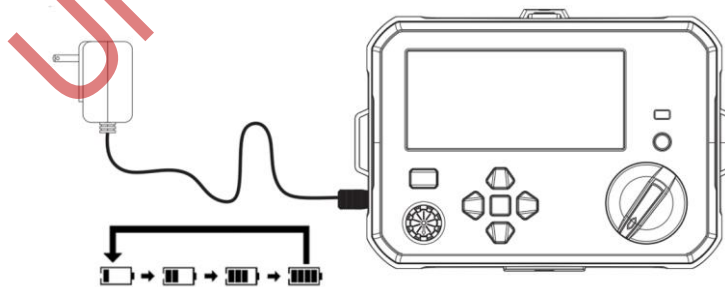

Figure 12.1 Tester charging

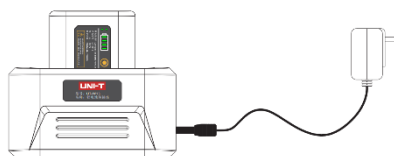

Figure 12.2 Charge the battery pack with the charging stand (UT-W13 Charging Stand: Optional)

**Note:** To avoid electric shock, please power off the Tester and disconnect all test leads before

removing the lithium battery pack.

## 13. Basic Measurements

### 13.1 Insulation Resistance Measurement

#### Warning:

- ⚠ Please wear insulated gloves (corresponding to measurement category) and take protective measures before making connection and measurement.
- ⚠ Before test, please make sure that no voltage is present at the measured object, and please do not measure the insulation resistance of energized equipment or circuit.
- ⚠ Please be careful to operate the Tester, since there is high voltage output! Make sure that the test leads contact the measured object well. Your hands shall be away from the test clips before pressing the TEST button to perform test.
- ⚠ Do not short the two test leads or measure insulation resistance during test (in high voltage output state), otherwise it can cause personal injury, fire, or damage to the Tester.
- ⚠ The measurement time shall not be longer than 10 s in the following cases: Measure resistance of lower than 0.10 MΩ at 100 V or 125V range, 0.25 MΩ at 250 V, 0.5 MΩ at 500 V, or 1 MΩ at 1000V.

Formula:  $R = \frac{U}{I}$  (Ohm's law)

R: Measured insulation resistance

U: Output voltage

I: Current of measured loop

Connect red test lead or remote-controlled test lead to "Insulation/V" terminal, and black to "COM". As shown in Figure 13.1.

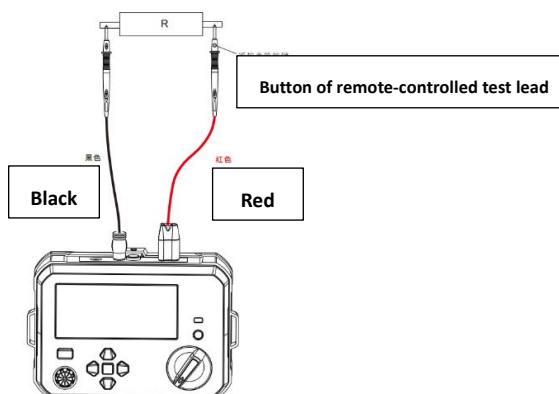

Figure 13.1 Connection of insulation resistance measurement

### 13.2 Continuous Measurement

Power on the Tester, then set the rotary switch to corresponding high voltage position (the Tester enters the corresponding continuous insulation resistance measurement mode, as shown in Figure 13.2). Please connect the test leads and the measured object, and then start test.

Note: By default, the time-set switch will be turned on after boot-up. The backlight needs to be turned on/off manually. When the test is stopped, the Tester holds the interface automatically with the symbol “HOLD” displayed.

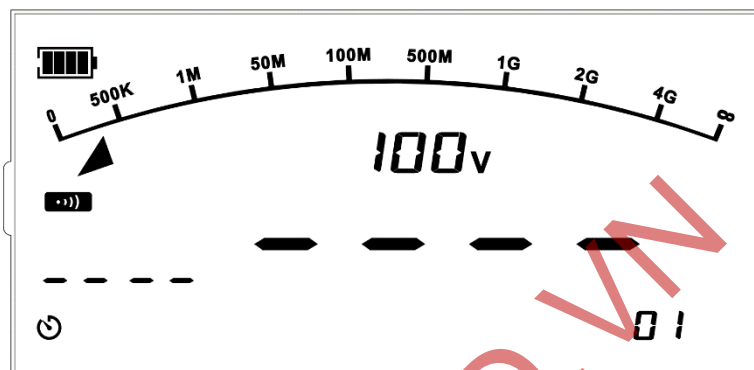

Figure 13.2 The Tester enters the continuous measurement mode at 100 V range after boot-up

Press the TEST button to start test, then the buzzer sounds, the red warning light is turned on, and the LCD shows the real-time battery power, high voltage warning symbol (blinks at 2 Hz), real-time high output voltage, tested insulation resistance, analog bar graph, continuous measurement time (start counting time when the test button is enabled), and other data or symbols, as shown in Figure 13.3.

**Note:** When the time condition is satisfied, the tester will automatically perform the operation of “Dielectric Absorption Ratio” (Default: 60s:15s; The time cannot be set) and “Polarization Index” (Default: 10min:1min; The time cannot be set), which will not displayed on the LCD directly. Please press the up/down arrow button to switch between the reading and the real-time output voltage, and to display corresponding symbol “DAR” or “PI”.

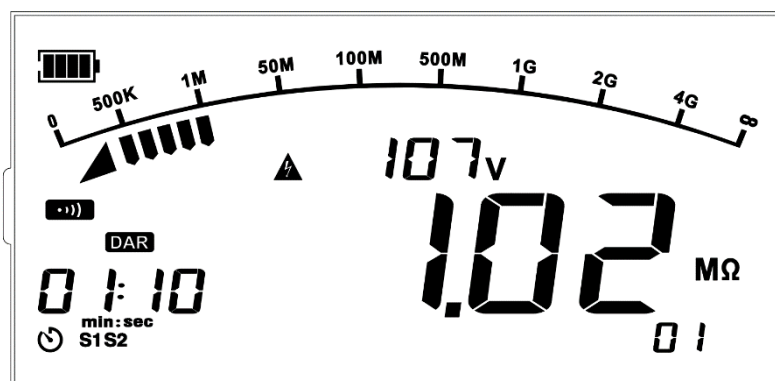

Figure 13.3 Start continuous test at 100V

Release the TEST button to stop measurement, then the high voltage output is turned off, the red indicator light is turned off, the buzzer sounds, and the Tester discharges electricity automatically. The LCD holds the present measurement value and other data, with the symbol “HOLD” displayed. As shown in Figure 13.4.

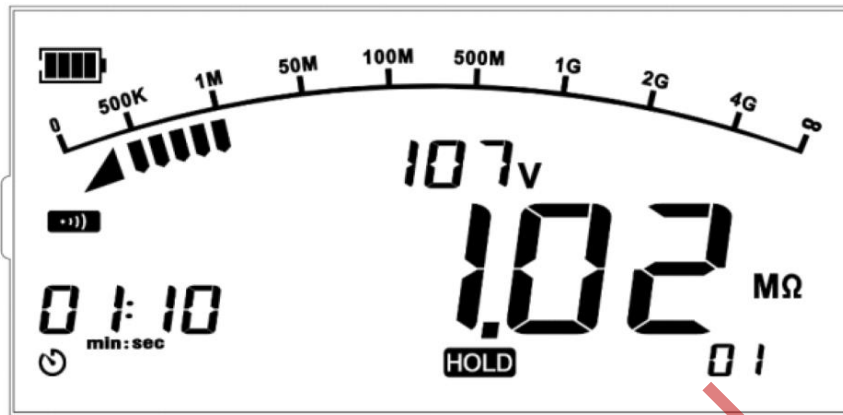

Figure 13.4 Stop continuous test at 107V

### 13.3 Time-Set Measurement

In insulation resistance measurement mode and without high voltage output, long press the left arrow button to enter the time-set measurement mode (with the default time “10:00” flashing and the symbols “TIME” and “SET” displayed), long press the OK button to complete the time setting in the time setting state (with the symbol “SET” off), then press the TEST button to start the time-set measurement (the countdown time is displayed and the symbol “TIME” blinks). When the countdown time is up (“00:00”), the test is stopped automatically, then long press again the left arrow button to exit the time-set measurement (the time will be saved). As shown in Figure 13.5.

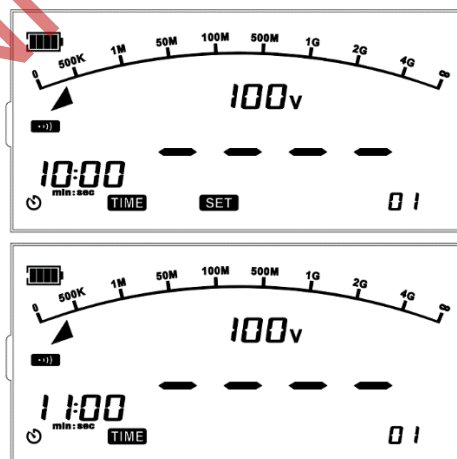

Figure 13.5 Time setting

Press the TEST button to start test, then the buzzer sounds, the red warning light is turned on, the symbol “TIME” flashes, and the LCD shows the battery power, high voltage warning symbol, buzzer symbol, real-time high output voltage, tested insulation resistance, analog bar graph, countdown time, etc. As shown in Figure 13.6.

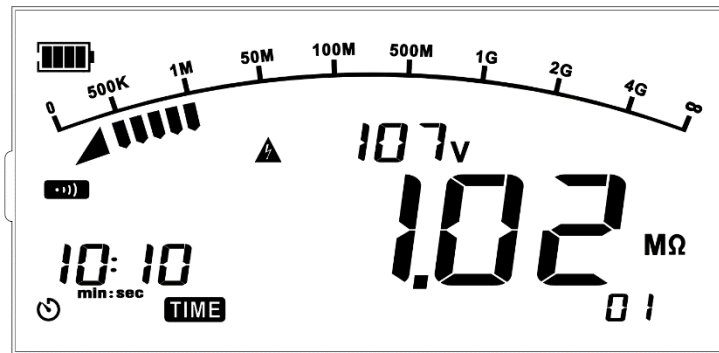

Figure 13.6 Start time-set measurement

When the time is up (“00:00”), the time-set measurement is stopped, the buzzer alarm is turned off, the red warning light is turned off, the Tester discharges electricity automatically, and the LCD holds the measurement value and other data automatically, as shown in Figure 13.7.

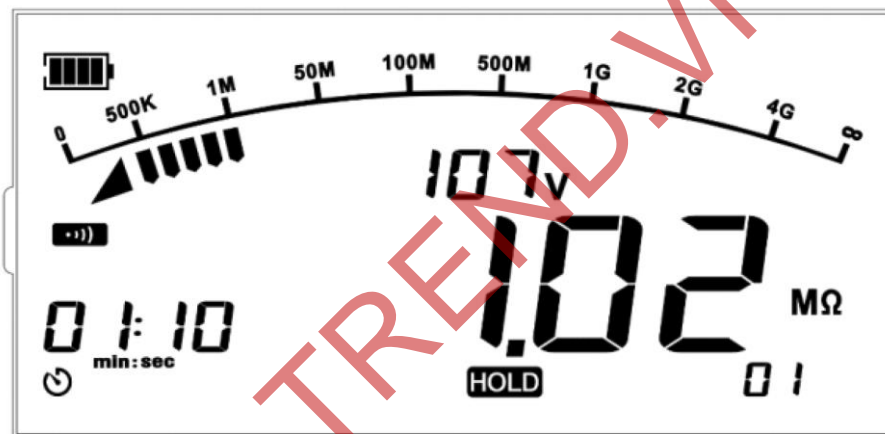

Figure 13.7 Stop time-set measurement

### 13.4 Comparative Measurement

In insulation resistance measurement mode and without high voltage output, long press the right arrow button to enter the comparative measurement mode (with the default comparative value “10MΩ” flashing and the symbols “COMP” and “SET” displayed), long press the OK button to complete the comparative value setting in the comparative value setting state (with the symbol “SET” off), press the TEST button to start comparative measurement (If the measured value is greater than the set value, the symbol “PASS” appears; otherwise “FAIL” appears), then long press again the right arrow button to exit the comparative measurement (the comparative value will be saved). As shown in Figure 13.8.

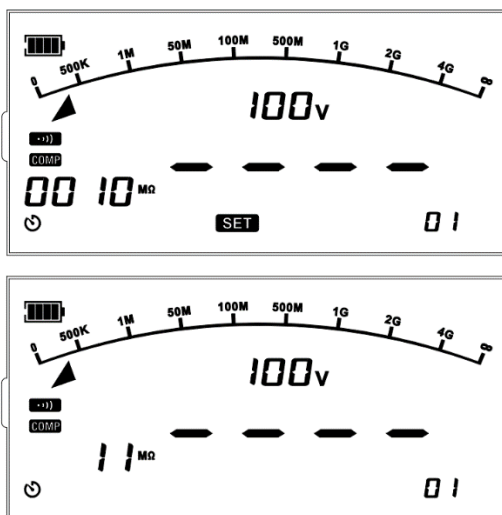

Figure 13.8 Setting of comparative measurement

Press the TEST button to start test, then the buzzer sounds, the red warning light is turned on, and the LCD shows the battery power, high voltage warning symbol, buzzer symbol, real-time high output voltage, tested insulation resistance, analog bar graph, “COMP” symbol, and other symbols. If the measured value is less than the set value, the symbol “FAIL” appears; otherwise “PASS” appears. As shown in Figure 13.9.

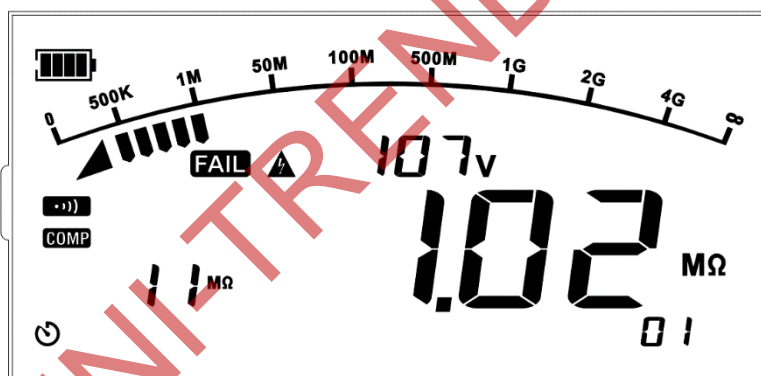

Figure 13.9 Comparative measurement at 1.00 MΩ is FAIL

Release the TEST button to stop the measurement, then the Tester turns off the output voltage, buzzer alarm and red warning light, discharges electricity automatically, and holds the measurement data and other data. As shown in Figure 13.10.

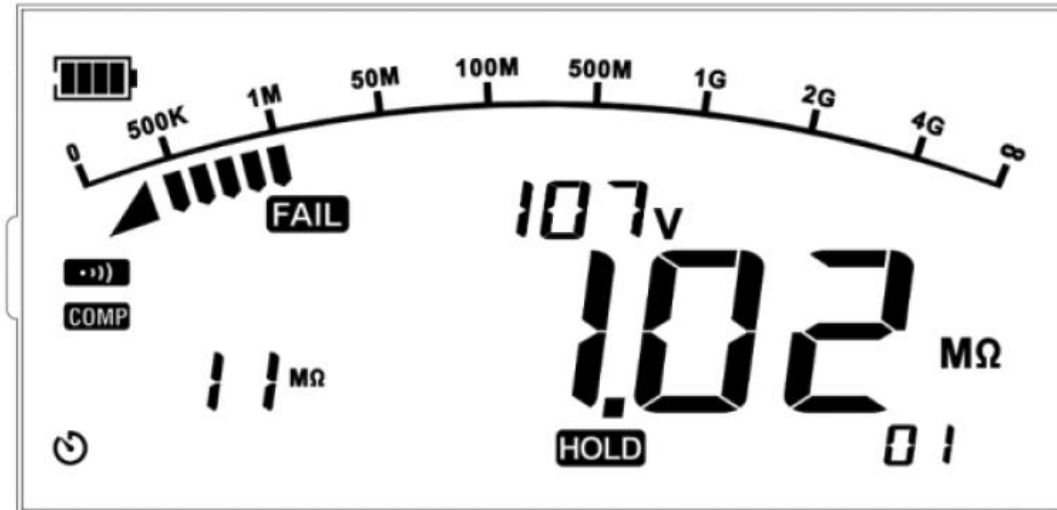

Figure 13.10 The failed comparative measurement at 1.00MΩ is completed

### 13.5 Voltage Measurement

Rotate the cutter to "VAC/DC" to enter the AC/DC voltage measurement mode (Figure 13.11). No external input voltage

Or the input voltage is not within the valid measurement range, the interface displays "LO V"; when the input voltage is within the valid measurement range, the instrument automatically recognizes the AC/DC and DC polarity and displays "VAC/DC".

When the input voltage is within the valid measurement range, the instrument automatically recognizes the AC/DC and DC polarity and displays the measured voltage value and the voltage attribute icon "AC" or "DC" or "-DC".

"-DC" and the high voltage warning symbol; when the device detects that the voltage exceeds the measurement range, the interface displays "OL V" or "-OL V".



Figure 13.11 Voltage measurement (Default interface)

#### Warning:

⚠ Do not measure voltage of >600VAC or >±600VDC. Higher voltage (5%) may be displayed,

but it may present a risk of damage to the Tester.

- ⚠ Please pay particular attention to avoid electric shock for high voltage measurement.
- ⚠ After all measurement operations are completed, please disconnect the test leads with the measured object and remove the test leads from the input terminal of Tester.

Connect the red test lead to the red clip or insert the red test rod to the “Insulation/V” terminal, and connect the black test lead to the black clip or insert the black test rod to the “COM” terminal. As shown in Figure 13.12.

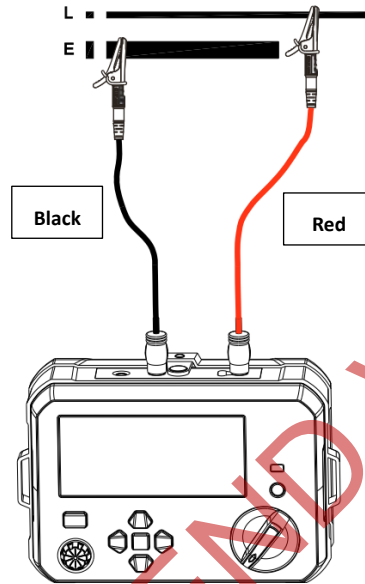

Figure 13.12 Connection of AC/DC voltage measurement

Connect the Tester to a loop with voltage of AC 150 V through the red and black test leads, as shown in Figure 13.13.



Figure 13.13 150VAC voltage measurement

Connect the Tester to a loop with voltage of AC 630 V through the red and black test leads, then the Tester indicates the measured voltage exceeds the range, as shown in Figure 13.14.



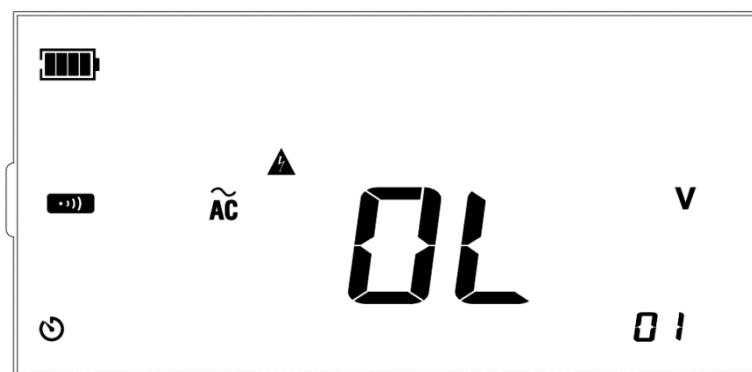

Figure 13.14 The measured AC voltage exceeds the range

### 13.6 Low Resistance Measurement

Set the rotary switch to “Ω” to enter the low resistance measurement mode (as shown in Figure 13.15). Please zero the error of test leads before test to ensure an accurate measured resistance. Make sure the test leads are not energized, short the red and black test leads, press the TEST button (with a small resistance of test leads displayed), then press the ZERO button to zero the resistance of test leads (with the symbol “ZERO” displayed, as shown in Figure 13.17); short press again to exit the zeroing mode (with the symbol “ZERO” off). Resistance of <math><20\Omega</math> can be zeroed. Make sure that the measured object is not energized before test, connect the test leads to the measured object, and then press the TEST button (with the measured value and terminal voltage displayed). If the measured resistance is <math><20\Omega</math>, the buzzer sounds continuously; if the measured resistance exceeds the range, “>420Ω” is displayed on the LCD.

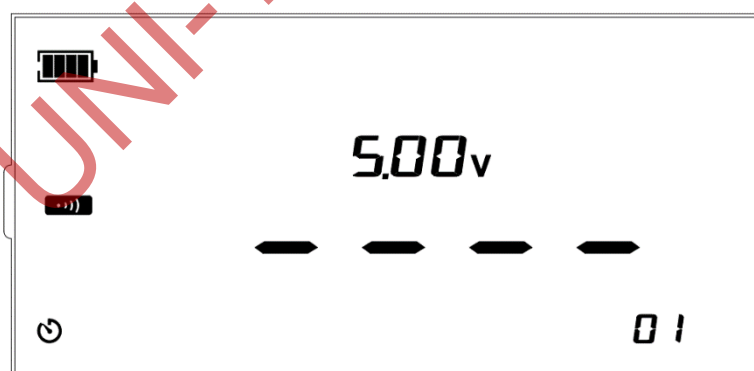

Figure 13.15 Low resistance measurement (Default interface)

Short the red and black test leads, then press the TEST button. The measured resistance is the actual internal resistance of test leads, as shown in Figure 13.16.



Figure 13.16 Test leads are shorted

The measurement will be affected by the internal resistance of test leads, thus please zero the internal resistance. Short press the ZERO button to zero the resistance (with the symbol “ZERO” displayed), as shown in Figure 13.17.

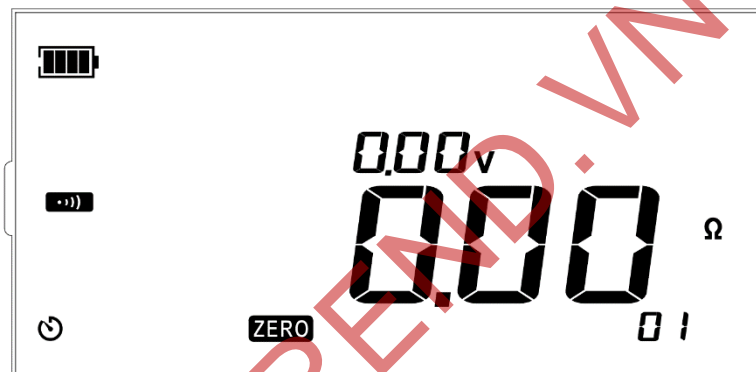

Figure 13.17 Resistance of shorted test leads is zeroed

Zero the internal resistance of test leads, connect the 4Ω resistance to the Tester through the red and black test leads, then the actual measured resistance is displayed on the LCD, as shown in Figure 13.18.

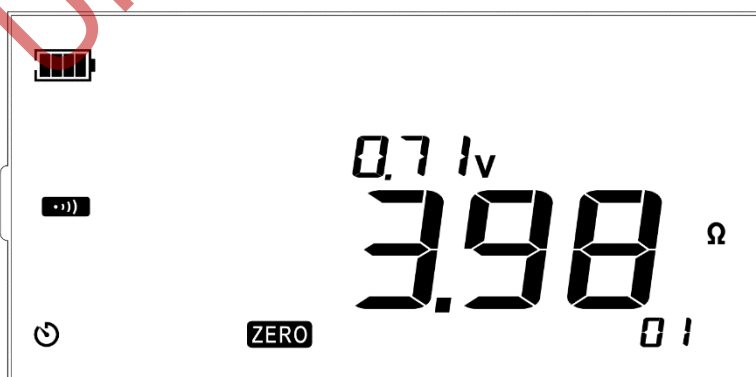

Figure 13.18 4Ω resistance measurement (Internal resistance zeroed)

Connect the 500Ω resistance to the Tester through the red and black test leads, then perform measurement. The measured resistance exceeds the range (with “>420Ω” displayed), as shown in Figure 13.19.



Figure 13.19 Low resistance exceeds the range

Connect the red test lead to the red clip or insert the red test rod to the “Ω/Continuity” terminal, and connect the black test lead to the black clip or insert the black test rod to the “COM” terminal. As shown in Figure 13.20.

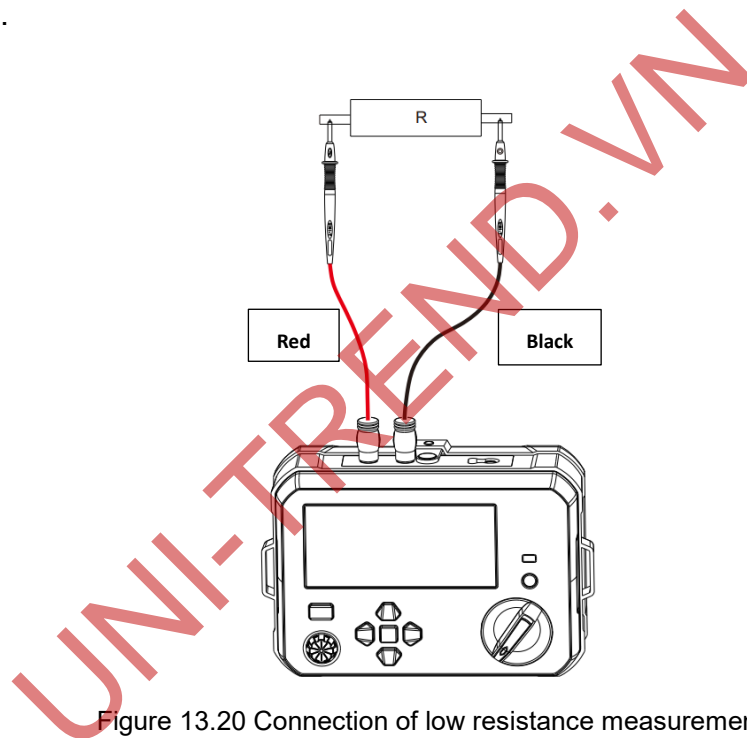

Figure 13.20 Connection of low resistance measurement

## 13.7 Save/Delete Data

In measurement mode, short press the SAVE button to save the current data (with the symbol “SAVE” blinking once, as shown in Figure 13.21). The symbol “FUL” will be displayed when 99 groups of data are saved (as shown in Figure 13.22). To save new data when the data storage is full, please delete the old data.

Long press the SAVE button to enter the data reading mode (with “READ” displayed), then the last group of saved data is displayed by default (as shown in Figure 13.20). Short press the up/down arrow button to read the saved data.

Short press the CLEAR button (with “CLR” displayed), then short press the OK button to delete the current data. Short press the CLEAR button again to cancel the deletion of current data (with “CLR” off).

Long press the CLEAR button (with “CLR” displayed), then short press the OK button to delete all saved data. Short press the CLEAR button again to cancel the deletion of all saved data (with “CLR” off).

Long press the SAVE button to exit the data reading mode (with “RAD” displayed).

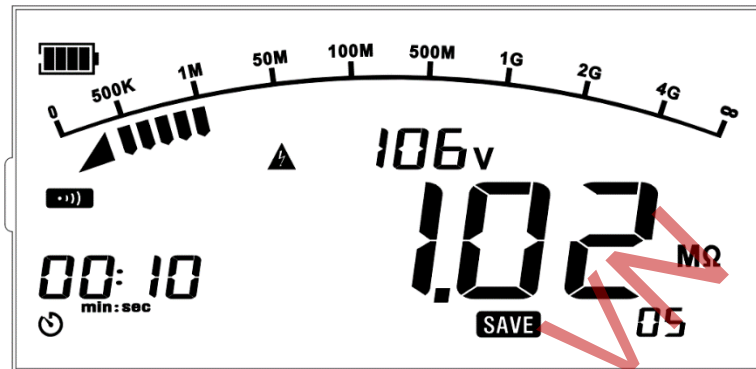

Figure 13.21 Save the current data in insulation measurement mode

Short press the SAVE button to save the current data (with the number of groups of saved data increased by 1). When the number of groups of saved data reaches 99, the interface will be displayed as shown in Figure 13.22.

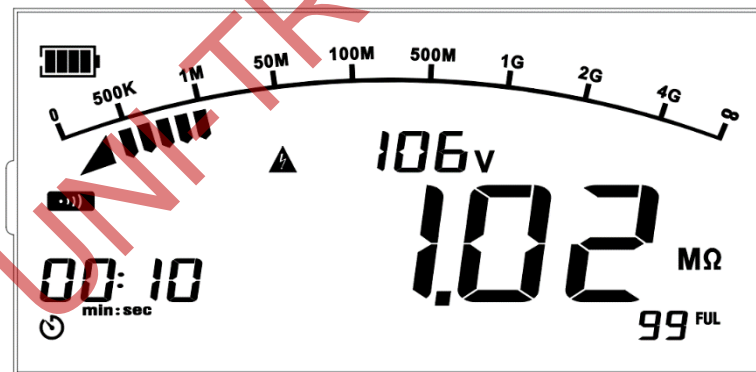

Figure 13.22 99 groups (full) of data are saved

Long press the SAVE button to enter the data reading mode (with “READ” displayed). When the data of group 05 is read, the interface will be displayed as shown in Figure 13.23.

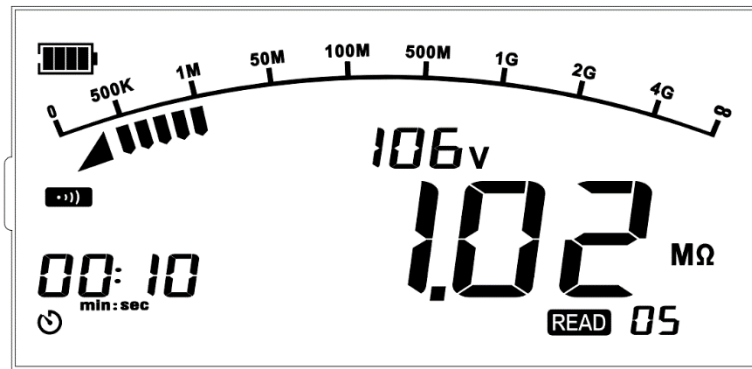

Figure 13.23 The data of group 05 is read

Short press the CLEAR button to enter the state of deleting the data of group 05, or long press to enter the state of deleting all saved data, as shown in Figure 13.24.

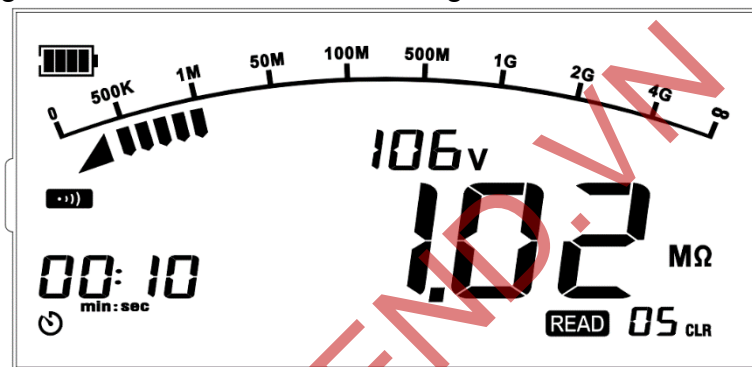

Figure 13.24 To delete the data of group 05 or all data

Long press the CLEAR button to enter the state of deleting all saved data, then press the OK button to confirm the deletion, as shown in Figure 13.25.

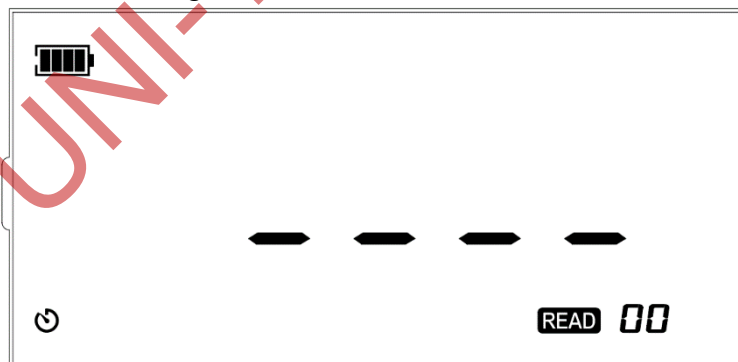

Figure 13.25 All saved data are deleted

### 13.8 USB and Bluetooth communications

Long press the up arrow button in any mode to enter the real-time USB upload mode (with the USB symbol displayed), then the current data is transmitted to the PC in real time.

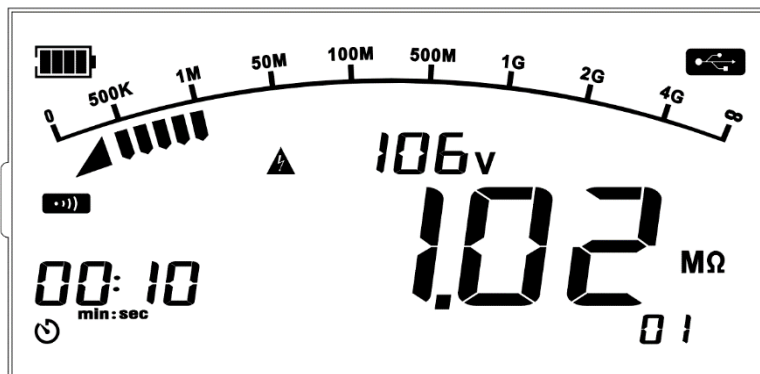

Figure 13.26 Real-time USB transmission in insulation measurement mode

Long press the up arrow button again to enter the one-button USB upload mode (with the USB symbol flashing at 2 Hz), then long press the OK button to upload all saved data. After successful load, the USB symbol stops flashing and the Tester enters the real-time upload mode. As shown in Figure 13.27.

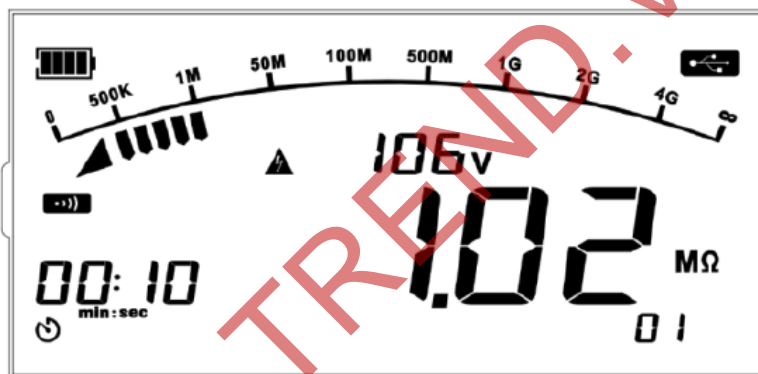

Figure 13.27 One-button USB upload in insulation measurement mode

Long press the up arrow button three times in any mode to enter the Bluetooth communication mode (with the Bluetooth symbol displayed), then the Tester communicates with the APP and transmits the current data. The Tester can be controlled and operated via the APP. As shown in Figure 13.28.

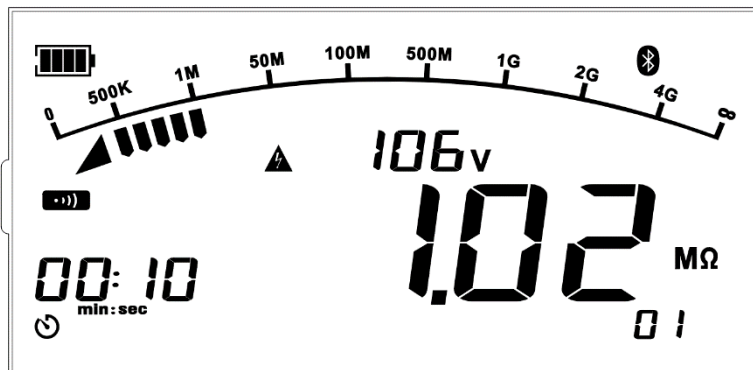

Figure 13.28 Bluetooth communication in insulation measurement mode

Long press the up arrow button again to turn on the USB and Bluetooth communication functions at the same time (with the USB and Bluetooth symbols displayed), then long press the up arrow button again to exit the USB and Bluetooth communications. As shown in Figure 13.29.

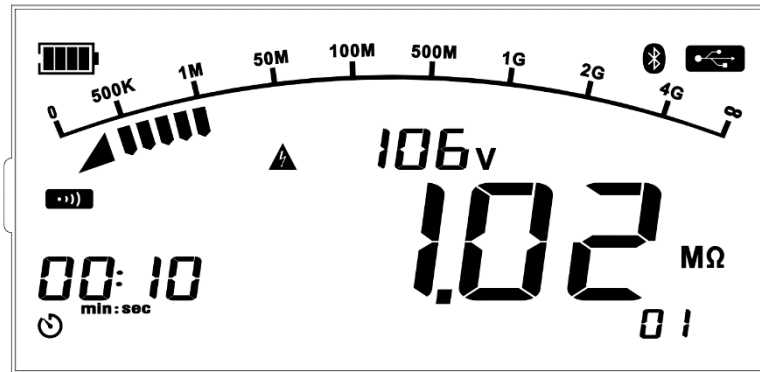

Figure 13.29 USB and Bluetooth communications in insulation measurement mode

## 14. Bluetooth and USB communications

The Tester supports Bluetooth and USB communication functions.  
Bluetooth software

### 14.1 Introduction

The Bluetooth software is a mobile APP and supports iOS 10.0 or newer and Android 5.0 or newer currently.

### 14.2 Download (iDMM2.0)

#### For Android:

Method 1: Search "iDMM2.0" from the official website of Uni-Trend.

Method 2: Open the mobile browser and scan the QR code below (Do not scan by WeChat).

Method 3: Search "iDMM2.0" at Google Play, Tencent My App, HUAWEI APP store, MI APP store, VIVO APP store, and OPPO APP store.

Method 1 or 2 is highly recommended for downloading latest software.

#### For IOS:

Method 1: Search "iDMM2.0" at "App Store".



For Android



For IOS

### 14.3 Use

a) Open the Bluetooth functions of both the Tester and mobile phone, tap the “iDMM2.0” APP icon on your phone desktop to open the software, then the software enters the navigation interface and searches nearby Bluetooth-enabled meters automatically. After that, select the corresponding meter and make connection. Alternatively, scan the QR code at the meter to make direct connection. In connected state, data communication, measurement result display, button control and other operations can be achieved.

b) “iDMM2.0” APP has multiple functions including Bluetooth communication, data recording, device management, report generation, data sharing, data synchronizing, and more. For the operating instructions about these functions, please refer to the “iDMM2.0” User Manual (Tap the menu button, “Setting” button, then “Help Guide” button for the User Manual)

### 14.4 Uninstallation

Uninstall the software through the uninstallation function of mobile phone.

## 15. Maintenance

#### Clean the casing:

1. Wipe the casing using soft cloth or sponge moistened with clear water.
2. Do not immerse the Tester into water!
3. Please dry the Tester before storage.
4. The calibration or maintenance shall be performed by professional personnel or designated servicing center.

***The contents of the manual are subject to change without further notice!***

WARNING: Cancer and reproductive harm-See [www.P65Warnings.ca.gov](http://www.P65Warnings.ca.gov) for more information