



P/N:11040110XXXXX  
2024.12.13  
REV.5

# UNI-T®



## UT253A/UT253B

### Operating Manual



Large Jaw Leakage Current Clamp Meter

## Contents

| TITLE  | PAGE |
|--|------|
| Warnings   | 2    |
| I. Introduction                                      | 4    |
| II. Model Comparison                                 | 5    |
| III. Electrical Symbols                              | 6    |
| IV. Technical Specifications                         | 7    |
| V. Meter Description                                 | 10   |
| VI. Operating Instructions                           | 12   |
| 1. Power On/Off                                      | 12   |
| 2. Backlight Control                                 | 12   |
| 3. Data Hold and Save                                | 12   |
| 4. Data Access and Exit                              | 13   |
| 5. Data Transmission to PC                           | 13   |
| 6. Data Delete                                       | 14   |
| 7. Leakage Current, Current and Voltage Measurements | 14   |
| VII. Battery Replacement                             | 18   |
| VIII. Packing List                                   | 19   |

### ⚠ Warnings

**Thank you for purchasing UNIT large jaw leakage current clamp meter .  
In order to use the product properly, please follow instructions  
below:**

- — — **Read user's manual carefully.**
- — — **Strictly observe safety rules and notes mentioned in this manual.**
- ◆ Please use the meter carefully under any circumstance.
- ◆ Pay attention to word labels and symbols on front and back panels
- ◆ Clamp jaw should be kept clean, regularly maintained and prevented from any severe strike
- ◆ Do not place and store the meter on sites exposed to high temperature, humidity, moisture condensing or strong sunshine
- ◆ Please timely change battery when low battery is indicated.
- ◆ Remove the battery away if the meter is not in use for a long time.

- ◆ Please ensure right polarity is selected when changing battery.
- ◆ Only authorized staff is allowed to use, discharge and repair the meter.
- ◆ Stop using the meter and pack immediately for authorized treatment if further operation will cause potential risks.
- ◆ “ ⚠ ” danger symbol is used on the meter and in the manual to require the operator should observe safety rules
- ◆ “ ☠ ” extreme danger mark is used in the manual to require the operator should strictly conform to the safety rules

## I. Introduction

UNIT large jaw leakage current clamp meter, supported by latest CT and digital integration technologies and coupled with large diameter clamp(80mm × 80mm, able to enclose  $\phi$  80mm cable or 96mm × 4mm flat steel ground wire) and automation function, is professional tool for measuring leakage current, current and voltage. It can simultaneously measure one-way leakage current and three-way voltages and offer simultaneous display on the screen, which all together allow users to operate easily and quickly. The meter is widely used in electric power, communications, meteorology, railway, oil field, construction, metrology, R&D institutes, mining, ect.







This kind of meter is designed with clamp iron core made with special alloy and latest magnetic screening technology, which make it able to avoid magnetic interference from outside and ensure high accuracy, stability and

reliability all the year around. It contains USB interface that allows its maximum storage of 99 sets of data to transfer into PC, thus facilitating further operations such as on-line monitoring, history lookup, dynamic display, history data recall, save and printing. Other functions such as backlight and data hold together with those mentioned above turn the meter a necessary tool for electrical safety testing.

## II. Model Comparison

| Model  | Range        | Resolution | Jaw Size    |
|--------|--------------|------------|-------------|
| UT253A | 0.00mA~1200A | 0.01mA     | 80mm × 80mm |
| UT253B | 0.0mA~2000A  | 0.1mA      | 80mm × 80mm |

### III. Electric Symbols

|   |   |
|---|---|
|  | Extreme danger! To avoid personal injury or accidents due to electric shock, observe safety rules strictly. |
|  | Danger! To avoid personal injury or accidents due to electric shock, please follow safety regulations.      |
|  | Warning! Conform to safety notes, otherwise it may cause personal injury or damage to the meter.            |
|  | Dual insulation   |
|  | Alternating Current (AC)  |
|  | Direct Current (DC)   |

### IV. Technical Specifications

|                    |  |
|--------------------|--|
| Functions          | to measure leakage current, current and three-phase AC voltage                     |
| Power              | 6V DC(LR6×4 Alkaline dry battery,12 hours of battery life)                         |
| Measuring Mode     | Clamp-shape CT, integral mode  |
| Jaw Size           | 80mm×80mm (Able to clamp $\phi$ 80mm conductor or 96mm×4mm flat steel ground line) |
| Range              | Current: AC 0.00mA~1200A   |
| Resolution         | Current: AC 0.01mA   |
| Conductor Location | Placed at the center of clamp jaw  |
| Data Save          | Maximum 99 sets, indicated by “ FULL ” flash icon.                                 |
| USB Port           | Yes, for data transmission to PC for further data analysis                         |

|  |  |
|--|--|
| Measuring Accuracy<br>(23°C ± 3°C, < 70%<br>RH, conductor located<br>at the center of jaw) | 0.00mA~300A: ±1.5% ± 3dgt<br>300A~1200A: ±2% ± 3dgt<br>1200A~2000A: ±3% ± 3dgt |
| Communication Line   | USB type, 1.8 meters long  |
| Frequency  | Self-identification between 50Hz and 60Hz                                      |
| Function Switchover  | Automatic  |
| Sample Rate  | about 2 times per second   |
| Circuit Voltage  | To measure AC voltage below 600V   |
| Display Mode   | LCD<br>Display Zone: 47 X 28.5mm   |
| Dimensions   | ( Long × wide × thick)275mm × 145mm × 40mm                                     |
| Backlight  | Controlled by <b>LIGHT</b> button  |
| Data Hold  | Data maintained: Indicated by “HOLD” icon                                      |

|                                 |   |
|---------------------------------|---|
| Overload Display                | Out of range: indicated by “OL” icon  |
| Auto Power Off                  | Automatically 15minutes later after power on, to conserve power energy              |
| Battery Voltage                 | Low battery icon displays with battery voltage below 5.2V, please change batteries. |
| Weight                          | The meter: 830g(battery and accessories included)                                   |
| Operating Temperature/ Humidity | -10°C ~ 40°C; < 80%rh   |
| Storage Temperature/ Humidity   | -10°C ~ 60°C; < 70%rh   |
| Insulation Strength             | AC 2kV/rms(Between iron core and housing)   |
| Safety Standards Followed       | IEC1010-1, IEC1010-2-032, Pollution Class 2, CAT III(600V)                          |

## V. Meter Description

1. Clamp Jaw
2. Function Buttons
3. LCD display
4. USB port
5. Trigger
6. Screws
7. Battery cover
8. Screw (to lock battery cover, 1pc)

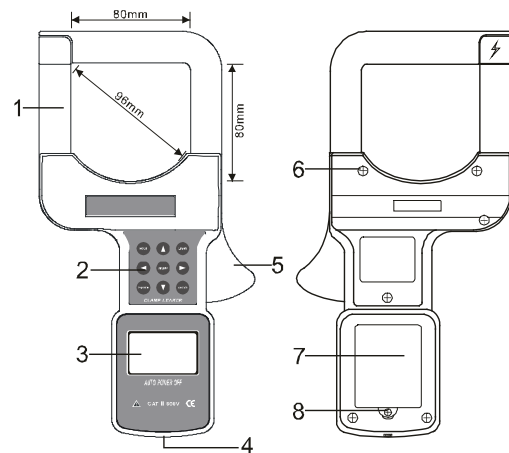

## VI. Operating Instructions

### 1. Power on/off

Press **POWER** button to power on, display LCD and enter into measuring mode, repress to turn off the meter. The meter will automatically switch off 15 minutes later after power on. You should change the battery if dark LCD appears after power on and may be caused by low battery voltage.

Under data save status, you need to press **HOLD** button to cancel the operation before press **POWER** button to power off the meter.

### 2. Backlight Control

Use **LIGHT** button to control backlight, suitable for dark sites and at night. The default is backlit status after power on.

### 3. Data Hold and Save

Under measuring mode, press **HOLD** button to maintain displayed data, indicated by “HOLD” icon, and repress to cancel the operation. The meter

will automatically number current data at the time of saving, indicated by group number such as “SAVE NO.: 001” . Maximum data storage is 99 sets and is achieved when “FULL” icon shows

### 4. Data Access and Exit

Under measuring mode, Press **MENU** to access data research with indication of “READ” icon. You can start data research from “R: 001” , press “ **Up** ” button to increment by 1, **down** button to increment by 10 and **MENU** button to exit this status and return to measuring mode.

### 5. Data Transmission to PC



The accessory USB connection line is used for communication of the meter with PC. With the meter power on and the software running, several following operations such as history lookup, data recall, save, report sheet, history printing can all be performed. The more data the meter saves, more time it will take to read out. History data can be saved in Txt or Excel format.





## 6. Data Delete

Press **CLEAR** button to select data clearing option under data access mode, then use **Left** or **Right** button to move the cursor for selecting “YES” or “NO”, finally press **MENU** button to confirm the operation or return to the measuring mode.

## 7. Leakage Current, Current and Voltage Measurements

|   |  |
|---|--|
|  | Dangerous Voltage! To avoid personal injury or accidents in case of electric shock, only trained and authorized staff is allowed to operate and must strictly observe safety rules |
|  | Danger! To avoid any damage to the meter or personal injury in case of electric shock do not measure voltage above 600V  |
|  | Please Keep the jaw properly open or close when measuring leakage current or current.<br>Try to place the conductor at the center of the jaw                                       |

|   |  |
|---|--|
|  | Please keep the jaw clean and regularly maintained after finishing measurement.                          |
|   | Ensure correct wire connection to avoid short-circuit problem during voltage measurement                 |
|   | Disconnect test leads with measured lines before pulling them out of the meter in case of electric shock |
|  | Clamping live and neutral wires is to measure leakage current of electric instruments(2 wires needed)    |
|   | Clamping the ground wire is to measure its leakage current (single wire needed)                          |
|   | Clamping all three phases and four wires is to measure total leakage current(four wires needed)          |
|   | Clamping the main wire is to measure current of the main circuit (single wire needed).                   |

## Measuring Reference Figure:

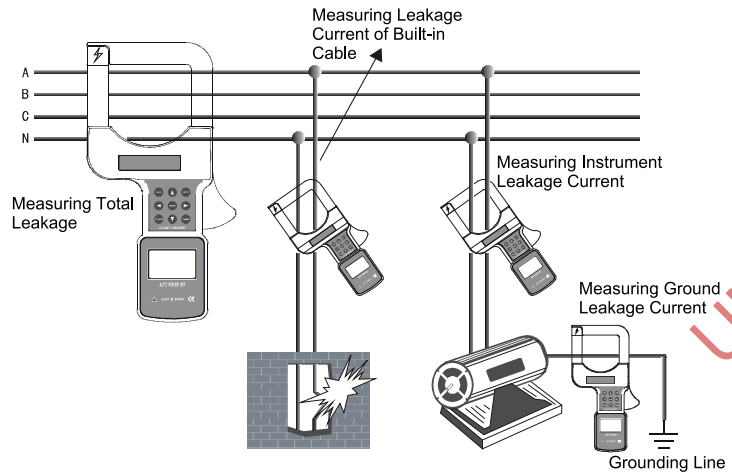

## VII. Battery Replacement

### ⚠ Warning !

- To avoid potential risks do not measure when battery cover is not well placed.
  - Please ensure right battery polarity, otherwise it will damage the meter.
  - Change batteries timely when low battery icon displays.
  - Take out batteries when not used for a long time.
1. Low battery icon displays with voltage lower than 5.2V, please change the battery timely.
  2. Press **POWER** button to switch off, loosen one screw on battery cover and open it after confirming the meter is off, finally change with new specified batteries and close the battery cover.
  3. Press “ **POWER** ” button to switch on and check if batteries are successfully replaced, if not, repeat the second step.

## VIII. Packing List

|                                   |       |
|-----------------------------------|-------|
| The Meter                         | 1     |
| Carrying case                     | 1     |
| USB cable                         | 1     |
| Battery(LR6 Alkaline Dry Battery) | 4PCs  |
| Giftbox/User's Manual             | 1 set |

**UNI-T®**

UT253A/253B OPERATING MANUAL

UT253A/253B OPERATING MANUAL

**UNI-T®**

UNI-TREND.VN

The manual information is subject to changes without prior notice.

**UNI-T®**  
**UNI-TREND TECHNOLOGY (CHINA) CO., LTD.**  
No6, Gong Ye Bei 1st Road,  
Songshan Lake National High-Tech Industrial  
Development Zone, Dongguan City,  
Guangdong Province, China  
Tel: (86-769) 8572 3888  
<http://www.uni-trend.com>