

# UNI-T®



**UT205E/UT206B  
UT207B/UT208B**

## Operating Manual



**1000A True RMS  
Digital Clamp Meter**



P/N:110401109411X

## Preface

Thank you for purchasing the new clamp meter. In order to use this product safely and correctly, please read this manual thoroughly, especially the *Safety* Instructions part.

After reading this manual, it is recommended to keep the manual at an easily accessible place, preferably close to the device, for future reference.

## Limited Warranty and Liability

Uni-Trend guarantees that the product is free from any defect in material and workmanship within one year from the purchase date. This warranty does not apply to damages caused by accident, negligence, misuse, modification, contamination or mishandling. The dealer shall not be entitled to give any other warranty on behalf of Uni-Trend. If you need warranty service within the warranty period, please contact your seller directly.

Uni-Trend will not be responsible for any special, indirect, incidental or subsequent damage or loss caused by using this device.

## Table of Contents

I. Overview .....	4
II. Accessories .....	4
III. Safety Instructions .....	5
IV. Electrical Symbols .....	6
V. External Structure .....	7
VI. LCD Display .....	8
VII. Function SwitchDial and Function Buttons .....	11
VIII. Specifications .....	13
IX. Operating Instructions .....	22
X. Maintenance .....	38

## I. Overview

The UT205E/UT206B/UT207B/UT208B is a 6000-count handheld true RMS clamp meter with auto range. This full scale overload protection meter contains the following features:

- AC/DC voltage, AC current, resistance, diode, continuity, capacitance, frequency, duty ratio, data hold, MAX/MIN, relative
- DC current (UT207B/UT208B)
- Temperature (UT206B/UT208B)
- LPF (low pass filter) and LoZ (low impedance) voltage (UT206B/UT207B/UT208B)
- Inrush current measurement (UT206B/UT207B/UT208B)
- Analog bar display (UT206B/UT207B/UT208B),
- Flashlight, NCV, low battery indication, and auto power off

The UT206B/UT208B can also be equipped with a flexible current probe to extend the AC current measurement range to 3000A (optional accessory).



### **Warning:**

Before using the meter, please read the Safety Instructions carefully.

## II. Accessories

Open the package box and take out the meter. Please double check whether the following items are missing or damaged.

- |   |          |
|---|----------|
| a) User manual .....                            | 1 pc     |
| b) Test leads .....                             | 1 pair   |
| c) K-type thermocouple (UT206B/UT208B) .....    | 1 pc     |
| d) Cloth bag .....                              | 1 pc     |
| e) 1.5V AAA batteries .....                     | 3 pcs    |
| f) Flexible current probe (UT206B/UT208B) ..... | optional |

If any of the above is missing or damaged, please contact your supplier immediately.













### III. Safety Instructions

The meter is designed and manufactured according to IEC61010-1, IEC61010-2-032 and IEC61010-2-033 safety standards, and conforms to CAT III 1000V, CAT IV 600V, double insulation, and pollution degree 2.

**⚠ Note:** Before each use, verify meter operation by measuring a known voltage. If the meter is used in a manner not specified by the manufacturer, the protection provided by the equipment may not be guaranteed.

1. Before use, please check if there is any item which is damaged or behaving abnormally. If any abnormal item (such as bare test lead, damaged meter casing, broken LCD, etc.) is found, or if the meter is considered to be malfunctioning, please do not continue to use the meter.
2. Do not use the meter if the rear cover or the battery cover is not completely covered up, it may pose a shock hazard!
3. When using the meter, keep fingers behind the finger guards of the test leads, and do not touch exposed wires, connectors, unused inputs, or circuits being measured to prevent electric shock.
4. The function dial should be placed in the correct position before measurement.
5. Do not apply voltage over 1000V between any meter terminal and earth ground to prevent electric shock or damage to the meter.
6. Use caution when working with voltage above AC 30Vrms, 42Vpeak or DC 60V. Such voltages pose a shock hazard.
7. Never input voltage or current which exceeds the specified limit. If the range of the measured value is unknown, the maximum range should be selected.
8. Before measuring the resistance, diode and continuity, switch off the power supply of the circuit, and fully discharge all capacitors to avoid inaccurate measurement.
9. When the “” symbol appears on the LCD, please replace the batteries in time to ensure measurement accuracy. If the meter is not in use for a long time, please remove the batteries.
10. Do not change the internal circuit of the meter to avoid damage to the meter and user!
11. Do not use or store the meter in high temperature, high humidity, flammable, explosive or strong magnetic field environments.
12. Clean the meter casing with a soft cloth and mild detergent. Do not use abrasives or solvents!

### IV. Electrical Symbols

Symbol	Description
	Equipment protected throughout by DOUBLE INSULATION or REINFORCED INSULATION
	Earth (ground)
	Warning or Caution
	Alternating current
	Direct current
	Continuity buzzer
	Diode
	Capacitance
	Alternating current or direct current
	Caution, possibility of electric shock
	Application around and removal from UNINSULATED HAZARDOUS LIVE conductors is permitted.
	Complies with European Union standards
	Conforms to UL STD 61010-1, 61010-2-032, 61010-2-033, Certified to CSA STD C22.2 No. 61010-1, 61010-2-032, 61010-2-033.
<b>CAT III</b>	It is applicable to testing and measuring circuits connected to the distribution part of the building's low-voltage MAINS installation.
<b>CAT IV</b>	It is applicable to testing and measuring circuits connected at the source of the building's low-voltage MAINS installation.

## V. External Structure (Picture 1)

1. Clamp jaws
2. Hand guard
3. LED indicator light
4. Jaw opening trigger
5. Function dial
6. LCD display
7. Function buttons
8. NCV sensor
9. FLIGHT button
10. Flashlight LED light
11. Battery cover
12. Input jacks

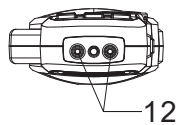
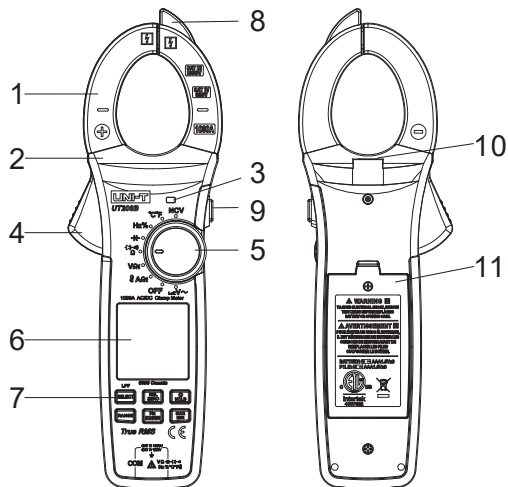

Picture 1

## VI. LCD Display (Picture 2, Picture 3, Picture 4)

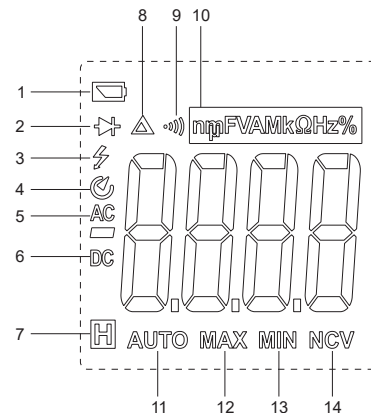

Picture 2 UT205E

1.	Low battery	8.	Relative value
2.	Diode test	9.	Continuity test
3.	High voltage	10.	Unit
4.	Auto power off	11.	Auto range
5.	AC signal	12.	Max measurement
6.	DC signal	13.	Min measurement
7.	Data hold	14.	NCV

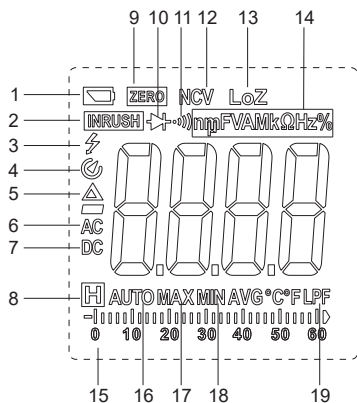

Picture 3 UT207B

1.	Low battery	11.	Continuity test
2.	Inrush current measurement	12.	NCV
3.	High voltage	13.	Low impedance measurement
4.	Auto power off	14.	Unit
5.	Relative value	15.	Analog bar
6.	AC signal	16.	Auto range
7.	DC signal	17.	Max measurement
8.	Data hold	18.	Min measurement
9.	DC current zero	19.	Low pass filter measurement
10.	Diode test		

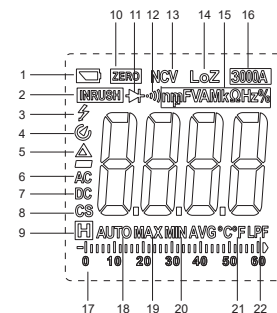

Picture 4 UT206B/UT208B

1.	Low battery	12.	Continuity test
2.	Inrush current measurement	13.	NCV
3.	High voltage	14.	Low impedance measurement
4.	Auto power off	15.	Unit
5.	Relative value	16.	Range indicator for the flexible current probe
6.	AC signal	17.	Analog bar
7.	DC signal	18.	Auto range
8.	Flexible current probe	19.	Max measurement
9.	Data hold	20.	Min measurement
10.	DC current zero	21.	Temperature measurement
11.	Diode test	22.	Low pass filter measurement

Remark 1: Regarding the range of the flexible current probe, the analog bar is defined as follows.

Range	Description
30.00A	One segment represents 1.00A
300.0A	One segment represents 10.0A
3000A	One segment represents 100A

## VII. Function Dial and Function Buttons

### 1. Function Dial

Dial Position	Description
	AC/DC current measurement
	AC/DC voltage measurement
	Resistance measurement
	Diode test
	Continuity test
	Capacitance measurement
	Frequency measurement
	Duty ratio measurement
	Temperature measurement
	Non-contact AC voltage sensing
	Measurement by flexible current probe
	Low pass filter measurement for AC voltage
	Low impedance measurement for AC voltage
	Power off

### 2. Function Buttons

#### Note:

**Short press:** pressing a button for less than 2s.

**Long press:** pressing a button for more than 2s.

#### 1) SELECT Button

**Short press:** switch between functions for each dial position.

**Long press:** enable/disable the LPF function in voltage mode.

#### 2) HOLD/⏻ Button

**Short press:** turn on/off data hold.

**Long press:** turn on/off backlight.

#### 3) MAX/MIN Button

**Short press:** enter maximum/minimum measurement mode (no auto power off function in this mode).

**Long press:** exit maximum/minimum measurement mode. Only valid for ACV, LoZ V~, DCV, ACA, DCA, Ω, CAP, °C/°F, and measurement by flexible current probe.

#### 4) REL or REL ZERO Button

**Short press:** enter/exit the relative value measurement mode.

LCD would display “ $\Delta$ ”.

Displayed value = measured value - reference value

Only valid for ACV, DCV, ACA, Ω and CAP (in the case of CAP, the REL button is used to clear the base).

In the DCA measurement mode, short press the REL ZERO button to enter/exit the zero mode.

#### 5) RANGE Button

**Short press:** enter the manual range mode and change the range.

**Long press:** Long press or turn function dial to exit manual range mode.

Only valid for ACV, LPF ACV, LoZ V~, DCV, ACA, DCA, CAP (UT205E only), and Ω.

## 6) Hz/INRUSH Button

**Short press:** enter/exit the frequency measurement mode.

Only valid for ACV, LPF ACV, LoZ V~, ACA and measurement by flexible current probe.

**Long press:** user has the option to select proper range with RANGE button first, or simply long press this button to enter the inrush current measurement mode (measurement time~100ms). Long press this button again to exit the inrush current measurement mode.

Inrush current can also be measured with flexible current probe (UT206B/UT208B).

## 7) Hz Button (UT205E only)

**Short press:** enter/exit the frequency measurement mode.

## 8) FLIGHT Button

**Short press:** turn on/off the flashlight.

# VIII. Specifications

## 1. General Specifications

Max display: -----	6000 counts
Polarity display: -----	Auto
Overload display: -----	"OL" or "-OL"
Low battery indication: -----	"  " is displayed.
Sampling rate: -----	3 times/s
Sensor type: -----	Coil induction (UT205E/UT206B) Hall effect sensor (UT207B/UT208B)
Test position error: -----	If the source under test is not placed at the center of the clamp jaws when measuring current, ±1.0% additional error in reading may be produced.
Jaw opening: -----	42mm
Battery: -----	3×1.5V AAA
Auto power off: -----	15 minutes (can be disabled)
Dimensions: -----	272mm×81mm×43.5mm
Weight (including batteries): -----	About 492g (UT205E/UT206B), 447g (UT207B/UT208B)

## 2. Environmental Specifications

Operating altitude:-----	2000m
Safety standards:-----	IEC61010-1, IEC61010-2-032, IEC61010-2-033; CAT III 1000V, CAT IV 600V
Pollution degree:-----	2
Operating temperature and humidity:-----	0°C~30°C (≤80%RH), 30°C~40°C (≤75%RH), 40°C~50°C (≤45%RH)
Storage temperature and humidity:-----	-10°C~60°C (≤80%RH)
Electromagnetic compatibility:-----	When RF=1V/m: overall accuracy = specified accuracy + 5% of range When RF>1V/m: not specified

## 3. Electrical specifications

Accuracy:-----	± (a% of reading + b digits), 1 year calibration cycle
Ambient temperature:-----	23°C±5°C
Ambient humidity:-----	≤80%RH

### Note:

To ensure measurement accuracy, the operating temperature should be within 18°C~28°C and the fluctuation range should be within ±1°C. When the temperature is <18°C or >28°C, add temperature coefficient error 0.1 x (specified accuracy)/°C.



## 1) AC Current ( $\tilde{A}$ )

Range	Resolution	Accuracy	Overload Protection
60.00A	0.01A	$\pm (2.0\%+5)$ , for UT205E/UT206B $\pm (2.0\%+9)$ , for UT207B/UT208B	1000V DC/AC
600.0A	0.1A	$\pm (2.0\%+5)$	
1000A	1A		

- Display: True RMS
- Accuracy guarantee: 5%~100% of range. Open circuit allows least significant digit  $\leq 10$ .
- Frequency response: 50Hz~60Hz (UT205E/UT206B), 40Hz~400Hz (UT207B/UT208B)
- When the measured current is above 500A, the continuous measurement time cannot exceed 60s (UT205E/UT206B).
- The AC crest factor will reach 3.0 at 3000 counts while only reach  $\leq 1.5$  at 6000 counts. The additional error should be added according to the crest factor of a non-sinusoidal wave are:
  - Add 4% when crest factor is 1~2
  - Add 5% when crest factor is 2~2.5
  - Add 7% when crest factor is 2.5~3
- For current frequency monitoring, the resolution is 0.1Hz and accuracy is  $\pm (0.1\%+3)$ . The input amplitude should be  $\geq 10\%$  of range.

## 2) Inrush Current ( $\tilde{A}$ )

Function	Range	Resolution	Accuracy	Overload Protection
Inrush current (ACA)	60.00A	0.01A	$\pm (10\%+10)$	1000A
	600.0A	0.1A		
	1000A	1A		
Inrush current (flexible current probe)	30.00A	0.01A	$\pm (10\%+10)$	3000A
	300.0A	0.1A		
	3000A	1A		

- measurement time ~ 100ms.

## 3) DC Current ( $\bar{A}$ )

Range	Resolution	Accuracy	Overload Protection
60.00A	0.01A	$\pm (2.0\%+5)$	1000A
600.0A	0.1A		
1000A	1A		

- Accuracy guarantee: 5%~100% of range
- Press the REL ZERO button to remove any DC offset that could affect the accuracy of reading.

#### 4) AC Voltage ( $\tilde{V}$ )

Range	Resolution	Accuracy	Overload Protection
6.000V	0.001V	$\pm (1.2\%+3)$	1000A
60.00V	0.01V		
600.0V	0.1V	$\pm (1.0\%+8)$	
1000V	1V		

- Display: True RMS
- Accuracy guarantee: 5%~100% of range. Short circuit allows least significant digit  $\leq 5$ .
- Input impedance:  $\geq 10M\Omega$
- Frequency response: 40Hz~400Hz
- The AC crest factor will reach 3.0 at 3000 counts while only reach  $\leq 1.5$  at 6000 counts. The additional error should be added according to the crest factor of a non-sinusoidal wave are:
  - Add 4% when crest factor is 1~2
  - Add 5% when crest factor is 2~2.5
  - Add 7% when crest factor is 2.5~3
- For voltage frequency monitoring, the resolution is 0.1Hz and accuracy is  $\pm (0.1\%+3)$ . The input amplitude should be  $\geq 10\%$  of range.

#### 5) LPF ACV

Range	Resolution	Accuracy	Overload Protection
600.0V	0.1V	$\pm (2.0\%+5)$	1000A
1000V	1V		

- Display: True RMS
- Accuracy guarantee: 5%~100% of range. Short circuit allows least significant digit  $\leq 5$ .
- Input impedance:  $\geq 10M\Omega$
- Frequency response: 40Hz~200Hz
- The AC crest factor will reach 3.0 at 3000 counts while only reach  $\leq 1.5$  at 6000 counts. The additional error should be added according to the crest factor of a non-sinusoidal wave as follows:

- Add 4% when crest factor is 1~2
  - Add 5% when crest factor is 2~2.5
  - Add 7% when crest factor is 2.5~3
- The -3dB frequency of LPF is about 2.5kHz  
Only manual range for LPF ACV. Use the RANGE button to change the range.
  - For voltage frequency monitoring, the resolution is 0.1Hz and accuracy is  $\pm (0.1\%+3)$ . The input amplitude should be  $\geq 10\%$  of range.

#### 6) LoZ V~

Range	Resolution	Accuracy	Overload Protection
600.0V	0.1V	$\pm (2.0\%+5)$	1000A
1000V	1V		

- Display: True RMS
- Accuracy guarantee: 5%~100% of range. Short circuit allows least significant digit  $\leq 5$ .
- Input impedance: About 2k $\Omega$
- Frequency response: 40Hz~400Hz
- The AC crest factor will reach 3.0 at 3000 counts while only reach  $\leq 1.5$  at 6000 counts. The additional error should be added according to the crest factor of a non-sinusoidal wave as follows:
  - Add 4% when crest factor is 1~2
  - Add 5% when crest factor is 2~2.5
  - Add 7% when crest factor is 2.5~3
- **When the measured voltage is above 220V, the continuous measurement time cannot exceed 30s and the rest interval should be more than 30s.**
- For voltage frequency monitoring, the resolution is 0.1Hz and accuracy is  $\pm (0.1\%+3)$ . The input amplitude should be  $\geq 10\%$  of range.

## 7) DC voltage (V<sub>DC</sub>)

Range	Resolution	Accuracy	Overload Protection
600.0mV	0.1mV	± (0.8%+3)	1000A
6.000V	0.001V	± (0.5%+5)	
60.00V	0.01V		
600.0V	0.1V		
1000V	1V		

- Input impedance:  $\geq 10M\Omega$
- Accuracy guarantee: 5%~100% of range. Short circuit allows least significant digit  $\leq 5$ .

## 8) Resistance ( $\Omega$ )

Range	Resolution	Accuracy	Overload Protection
600.0 $\Omega$	0.1 $\Omega$	± (1.0%+3)	1000A
6.000k $\Omega$	0.001k $\Omega$	± (1.0%+2)	
60.00k $\Omega$	0.01k $\Omega$		
600.0k $\Omega$	0.1k $\Omega$		
6.000M $\Omega$	0.001M $\Omega$	± (2.0%+8)	
60.00M $\Omega$	0.01M $\Omega$		

- Measurement result = displayed value – resistance of shorted test leads
- Open circuit voltage: About 1V
- Accuracy guarantee: 5%~100% of range

## 9) Continuity (••))

Range	Resolution	Accuracy	Overload Protection
600.0 $\Omega$	0.1 $\Omega$	Open circuit: Resistance $\geq 70\Omega$ , no beep Well-connected circuit: Resistance $\leq 30\Omega$ , consecutive beeps	1000A

- Open circuit voltage: About 1V
- Resistance value is between 30 $\Omega$  and 70 $\Omega$ , the Buzzer maybe beep

## 10) Diode (▶)

Range	Resolution	Accuracy	Overload Protection
6.000V	0.001V	Open circuit voltage: About 3V Measurable PN junction: Forward voltage drop $\leq 3V$ For silicon PN junction, the normal value is generally about 0.5~0.8V.	1000A

## 11) Capacitance (F)

Range	Resolution	Accuracy	Overload Protection
60.00nF	0.01nF	± (4.0%+25)	1000A
600.0nF	0.1nF	± (4.0%+5)	
6.000 $\mu$ F	0.001 $\mu$ F		
60.00 $\mu$ F	0.01 $\mu$ F		
600.0 $\mu$ F	0.1 $\mu$ F		
6.000mF	0.001mF	± (10.0%+9)	
60.00mF	0.01mF		

- Measurement result = displayed value – capacitance of open-circuit test leads
- For capacitance  $\leq 1\mu\text{F}$ , it is recommended to use “REL” measurement mode.
- Accuracy guarantee: 5%~100% of range

## 12) Temperature (°C/°F)

Range	Resolution	Accuracy	Overload Protection
-40°C~300°C	0.1°C	$\pm (1.0\%+20)$	1000V
300°C~1000°C	1°C	$\pm (1.0\%+2)$	
-40°F~572°F	0.2°F	$\pm (1.0\%+40)$	
573°F~1832°F	1°F	$\pm (1.0\%+4)$	

- Only K-type thermocouple is applicable.
- If the ambient temperature in the meter differs by  $\pm 5^\circ\text{C}$ , the accuracy can only be guaranteed after 1 hour of cool down.
- Open circuit display: “OL”

## 13) Frequency/Duty Ratio (Hz%)

Range	Resolution	Accuracy	Overload Protection
10Hz~1 MHz	0.01Hz~1K Hz	$\pm (0.1\%+3)$	1000V
10.0%~90.0%	0.1%	$\pm (2.6\%+7)$	

- Frequency input amplitude:
  - 10Hz~100kHz:  $250\text{mVrms} \leq \text{input amplitude} \leq 20\text{Vrms}$
  - 100kHz~1MHz:  $600\text{mVrms} \leq \text{input amplitude} \leq 20\text{Vrms}$
- Duty ratio:
  - 10%~90%: for square waves of 10Hz~1kHz
  - 30%~70%: for square waves of 1kHz~10kHz
  - $2\text{Vpp} \leq \text{input amplitude} \leq 20\text{Vpp}$

## 14) Non-contact AC voltage sensing (NCV)

Range	Accuracy	Overload Protection
NCV	Bring the NCV sensor (upper tip) close to a wire to start sensing. When no voltage is sensed, the LCD displays “EF”. As the intensity of the detected voltage increases, more segments “—” will be displayed, and higher frequently occurs for buzzer and flashing LED.	1000V

## IX. Operating Instructions

### 1.Related Measurement of AC Current (Picture 5)

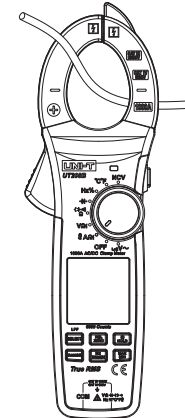

Picture 5

## AC Current Measurement

- 1) Turn the function dial to **A~**, **A~**, or **A~** position.
- 2) Press the trigger to open clamp jaws and fully enclose one conductor (only one conductor can be measured at a time). For optimum results, center the conductor in the jaws.

## Current Frequency Measurement

- 1) When the function dial is in the AC current position, short press the Hz or Hz/INRUSH button to enter the frequency measurement mode.
- 2) Short press the Hz or Hz/INRUSH button again to exit the frequency measurement mode.

## Inrush Current Measurement (for AC current)

- 1) User has the option to select proper range with RANGE button first, or simply long press the Hz/INRUSH button to enter the inrush current measurement mode.
- 2) Start the device under test and measure the instantaneous inrush current of the device.
- 4) Long press the Hz/INRUSH button again to exit the inrush current measurement mode.

Inrush current is the highest AC current (true RMS) within 100ms of start time, as shown below.

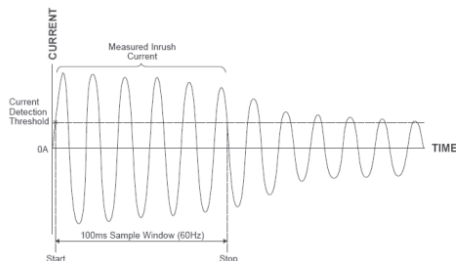

## ⚠ Note:

- The current measurement should be taken within 0°C~40°C. Do not suddenly release the trigger, as the impact may change the reading for a short time.
- To ensure measurement accuracy, center the conductor within the jaws. Otherwise, ±1.0% additional error in reading may be produced.
- When testing high current, the clamp will vibrate slightly, which is a normal phenomenon.

## 2. DC Current Measurement (Picture 5)

- 1) Turn the function dial to the **A=** or **A=** position.
- 2) Short press the SELECT button to switch to DC current measurement. If the display on the LCD is not zero, short press the REL ZERO button to enable zero clearing.
- 3) Press the trigger to open the clamp jaws, and fully enclose one conductor (only one conductor can be measured at a time). For optimum results, center the conductor within the jaws.

## ⚠ Note:

- The current measurement must be taken within 0°C~40°C. For DC current measurement, if the reading is positive, the direction of current is from top to bottom (from panel to cover). Do not suddenly release the trigger, as the impact will change the reading for a short time.
- To ensure measurement accuracy, center the conductor in within jaws. Otherwise, ±1.0% additional error in reading will be produced.
- After DC current (especially large current) measurement, the open circuit base may be too large. Please do an AC current test to eliminate the residual magnetic signal generated by the jaws.

### 3. Measurement by Flexible Current Probe (Picture 6)

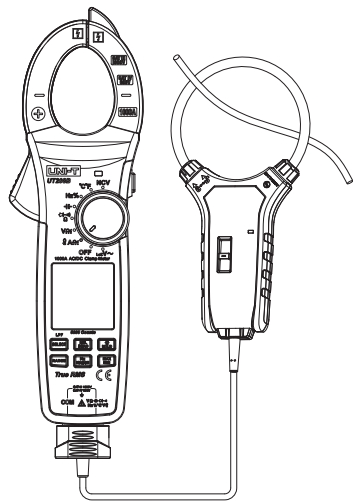

Picture 6

#### AC Current Measurement

- 1) Turn the function dial to the  $\text{A}^{\sim}$  or  $\text{A}_{\text{eff}}$  position.
- 2) Insert the flexible current probe into the  $\text{V}\Omega\text{Hz}\text{mA}$  and **COM** jacks.
- 3) The meter will automatically switch to the flexible current probe with the extended current range, displayed on LCD.

#### Current Frequency Measurement

- 1) After connecting the flexible current probe, short press the Hz/INRUSH button to enter the frequency measurement mode.
- 2) Short press the Hz/INRUSH button again to exit frequency measurement mode.

#### Inrush Current Measurement

- 1) After connecting the flexible current probe, short press the RANGE button to select the proper range.
- 2) Long press the Hz/INRUSH button to enter the inrush current measurement mode.
- 3) Start the appliance under test and measure the instantaneous inrush current of the appliance.
- 4) Long press the Hz/INRUSH button again to exit the inrush current measurement mode.

Inrush current is the highest AC current (true RMS) within 100ms of start time, as shown below.

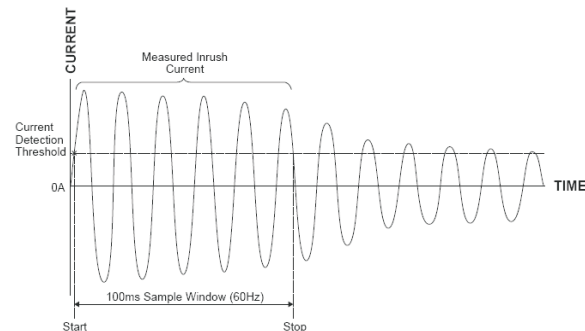

## 4. Related Measurement of AC Voltage and LPF ACV (Picture 7)

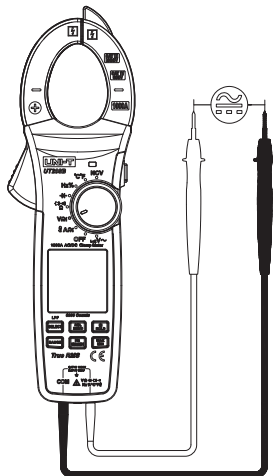

Picture 7

### AC Voltage Measurement

- 1) Insert the red test lead into  $V\Omega Hz\%$ ,  $\Omega Hz\%$ , or  $V\Omega Hz\%$  jack, and black test lead into the COM jack.
- 2) Turn the function dial to  $V\sim$  or  $V\approx$  position.
- 3) Short press the SELECT button to switch to AC voltage measurement if required, and connect the test leads with the measured load or power supply in parallel.

### Voltage Frequency Measurement

- 1) When the function dial is in the AC voltage, short press Hz or Hz/INRUSH button to enter the frequency measurement mode.
- 2) Short press Hz or Hz/INRUSH button again to exit frequency measurement mode.

### LPF ACV Measurement

- 1) When the function dial is in the AC voltage position, long press SELECT button to enable LPF ACV function. LPF can measure combined sine wave signals produced by inverters and variable frequency drives, as shown below.

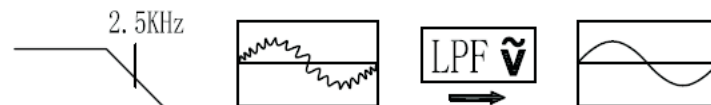

- 2) After enabling the LPF ACV function, short press the Hz/INRUSH button to enter the frequency measurement mode.
- 3) Short press the Hz/INRUSH button again to exit the frequency measurement mode.

### ⚠ Note:

- Do not input voltage above 1000V. Although it is possible to measure higher voltage, it may damage the meter.
- Be cautious to avoid electric shock when measuring high voltage.
- After completing the measurement, disconnect the test leads from the circuit under test.
- When the measured voltage is above 30V, the LCD will display the high voltage alarm prompt “⚡”.

## 5. DC Voltage Measurement (Picture 7)

- 1) Insert the red test lead into the  $\frac{V}{\Omega}$  Hz %  $\frac{\Omega}{Hz}$  % or  $\frac{V}{Hz}$  %  $\frac{Hz}{\Omega}$  % jack, and black test lead into the COM jack.
- 2) Turn the function dial to the  $V_{\text{DC}}$  or  $V_{\text{AC}}$  position.
- 3) Short press the SELECT button to switch to DC voltage measurement if required, and connect the test leads with the measured load or power supply in parallel.
- 4) Read the voltage value on the display.

### ⚠ Note:

- Do not input voltage above 1000V. Although it is possible to measure higher voltage, it may damage the meter.
- When measuring at 600mV range, use "REL" measurement mode to get accurate readings. Short-circuit the test leads, and then short press the REL or REL ZERO button. Read the measured voltage after the voltage of the short-circuited test leads is automatically subtracted.
- Be cautious to avoid electric shock when measuring high voltage.
- After completing the measurement, disconnect the test leads from the circuit under test.
- When the measured voltage is above 30V, the LCD will display the high voltage alarm prompt "⚡".

## 6. LoZ Measurement (Picture 8)

### LoZ ACV Measurement

- 1) Insert the red test lead into  $\frac{\Omega}{Hz}$  % or  $\frac{V}{Hz}$  % jack, and black test lead into the COM jack.
- 2) Turn the function dial to the **LoZ V~** position, and connect the test leads with the measured load or power supply in parallel.

### LoZ ACV Frequency Measurement

- 1) When the function dial is in the LoZ ACV position, short press the Hz/INRUSH button to enter the frequency measurement mode.
- 2) Short press the Hz/INRUSH button again to exit the frequency measurement mode.

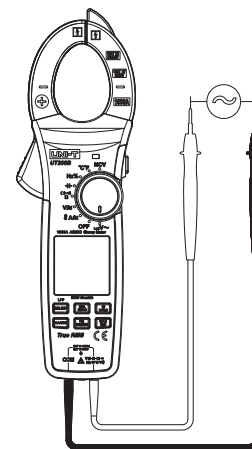

Picture 8

### ⚠ Note:

- Do not input voltage above 1000V. Although it is possible to measure higher voltage, it may damage the meter.
- Be cautious to avoid electric shock when measuring high voltage.
- Test known voltage before use to verify whether the product functions correctly.
- After using the LoZ function, let the meter rest for 3 minutes before next use.
- LoZ voltage measurement eliminates ghost voltage for more accurate measurement.
- When the measured voltage is above 30V, the LCD will display the high voltage alarm prompt "⚡".



## 7. Resistance Measurement (Picture 9)

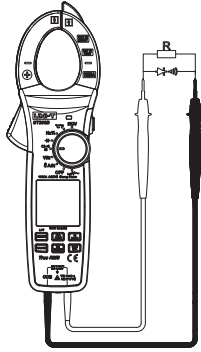

Picture 9

- 1) Insert the red test lead into the  $\frac{V}{\Omega}$ Hz%,  $\frac{\Omega}{\Omega}$  or  $\frac{V}{\Omega}$ Hz% jack, and black test lead into the COM jack.
- 2) Turn the function dial to the  $\frac{\Omega}{\Omega}$  or  $\frac{\Omega}{\Omega}$  position, short press the SELECT button to switch to resistance measurement if required, and connect the test leads with both ends of the measured resistance in parallel.

### ⚠ Note:

- If the measured resistor is open or the resistance exceeds the maximum range, the LCD will display "OL".
- Before measuring the resistance online, switch off the power supply of the circuit, and fully discharge all capacitors to ensure accurate measurement.
- When measuring low resistance, the test leads will produce 0.1Ω~0.2Ω measurement error. Use "REL" measurement mode to get accurate readings. Short-circuit the test leads, and then short press the REL or REL ZERO button. After the meter automatically subtracts the resistance of the short-circuited test leads, the low-resistance measurement can be performed.
- If the resistance is not less than 0.5Ω when the test leads are short-circuited, please check the test leads for abnormalities.

- When measuring resistance above 1MΩ, it is normal to take a few seconds to stabilize reading.
- Use caution when working with voltage above AC 30Vrms, 42Vpeak or DC 60V. Those voltages may pose shock hazard.
- After completing the measurement, disconnect the test leads from the circuit under test.

## 8. Continuity Test (Picture 9)

- 1) Insert the red test lead into the  $\frac{V}{\Omega}$ Hz%,  $\frac{\Omega}{\Omega}$  or  $\frac{V}{\Omega}$ Hz% jack, and black test lead into the COM jack.
- 2) Turn the function dial to the  $\frac{\Omega}{\Omega}$  or  $\frac{\Omega}{\Omega}$  position, short press SELECT button to switch to continuity test, and connect the test leads with both ends of measured load in parallel.
- 3) When the measured resistance  $\leq 30\Omega$ : The circuit is in good conduction status; the buzzer beeps continuously. When measured resistance  $\geq 70\Omega$ : there will be no buzzer sound.

### ⚠ Note:

- Before measuring the continuity online, switch off the power supply of the circuit, and fully discharge all capacitors.
- Use caution when working with voltage above AC 30Vrms, 42Vpeak or DC 60V. Those voltages may pose shock hazard.
- After completing the measurement, disconnect the test leads from the circuit under test.

## 9. Diode Test (Picture 9)

- 1) Insert the red test lead into the  $\frac{V}{\Omega}$ Hz%,  $\frac{\Omega}{\Omega}$  or  $\frac{V}{\Omega}$ Hz% jack, and black test lead into the COM jack. The polarity of the red test lead is "+" and that of the black test lead is "-".
- 2) Turn the function dial to the  $\frac{\Omega}{\Omega}$  or  $\frac{\Omega}{\Omega}$  position, and short press the SELECT button to switch to diode test.

- 3) Connect the red probe with the diode anode, and black with the diode cathode.
- 4) Read the approximate forward voltage of the diode on the display. For silicon PN junction, the normal value is generally about 500~800 mV.

**⚠ Note:**

- If the diode is open or its polarity is reversed, the LCD will display "OL".
- Before measuring the diode online, switch off the power supply of the circuit, and fully discharge all capacitors.
- Use caution when working with voltage above AC 30Vrms, 42Vpeak or DC 60V. Such voltage poses a shock hazard.
- After completing the measurement, disconnect the test leads from the circuit under test.

## 10. Capacitance Measurement (Picture 10)

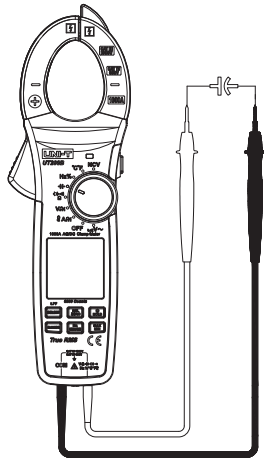

Picture 10

- 1) Insert the red test lead into the  $V\Omega Hz\%$ ,  $\Omega$ ,  $\mu F$  or  $V Hz\%$  jack, and black into the **COM** jack.
- 2) Turn the function dial to the  $\mu F$  or  $\mu F$  position, short press the SELECT button to switch to capacitance measurement, and connect the test leads with both ends of the measured capacitance in parallel.

**⚠ Note:**

- If the measured capacitor is short-circuited or the capacitance exceeds the maximum range, the LCD will display "OL".
- The analog bar pointer is disabled in capacitance measurement mode. When measuring capacitance  $>600\mu F$ , it may take some time to steady the readings.
- Before measuring, fully discharge all capacitors (especially high-voltage capacitors) to avoid damage to the meter and user.
- After completing the measurement, disconnect the test leads from the circuit under test.

## 11. Frequency/Duty Ratio Measurement (Picture 11)

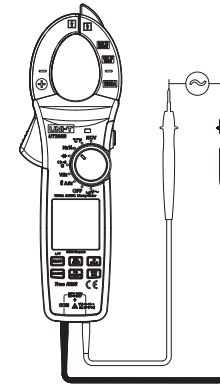

Picture 11

- 1) Insert the red test lead into the  $\frac{VQ}{Hz\%}$ ,  $\frac{Q}{Hz\%}$  or  $\frac{VQ}{Hz\%} \frac{C}{F}$  jack, and black into the **COM** jack.
- 2) Turn the function dial to the Hz% position, and connect the test leads with both ends of the measured signal source in parallel.
- 3) Short press the SELECT button to switch to frequency/duty ratio measurement.

**⚠ Note:**

- Do not input voltage higher than 30Vrms to avoid personal injury.
- After completing the measurement, disconnect the test leads from the circuit under test.

## 12. Temperature Measurement (Picture 12)

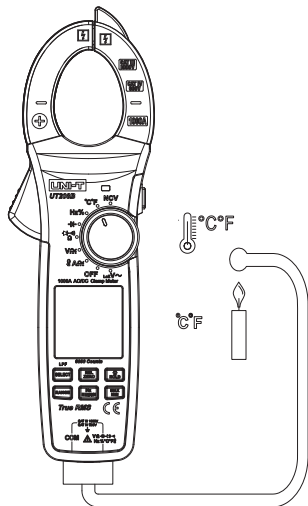

Picture 12

- 1) Turn the function dial to the °C/°F position, and the LCD will display "OL". Ambient temperature will be displayed if users short-circuit the test leads.
- 2) Insert the K-type thermocouple into the meter as shown.
- 3) Use the temperature sensor to measure object surface, and read the Celsius temperature value on the LCD after a few seconds.
- 4) Short press the SELECT button to switch to Fahrenheit temperature measurement.

**⚠ Note:**

- The ambient temperature of the meter should be in the range of 18-28°C, otherwise it may cause measurement error, especially in low temperature environments.
- Use caution when working with voltage above AC 30Vrms, 42Vpeak or DC 60V. Such voltage poses a shock hazard.
- After completing the measurement, remove the thermocouple.

## 13. Non-contact AC voltage sensing (NCV) (Picture 13)

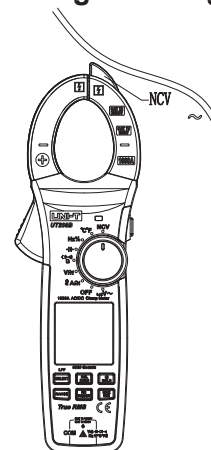

Picture 13

- 1) Turn the function dial to the NCV position, and bring the NCV sensor close to the wire under test.
- 2) If there is AC voltage or electromagnetic field in the space, the LCD will display the sensing intensity from weak to strong by “—”. At the same time, the buzzer will beep intermittently and the LED indicator light will be on. When no voltage is sensed, the LCD displays “EF”.

## 14. Auto Power Off

During measurement, if there is no operation of the function dial or any button for 15 minutes, the meter will automatically shut down to save power. Users can wake it up by pressing any button (except FLIGHT button). To disable the auto-off function, press and hold the SELECT button in the off state and turn on the meter.

## 15. Use of Test Leads

### 1) Testing in CAT III/CAT IV measurement locations:

Ensure the test lead shields are pressed firmly in place. Failure to use the CATIII/CATIV shields increases arc-flash risk.

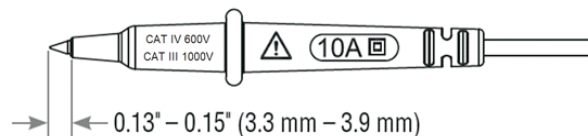

### 2) Testing in CAT II measurement locations:

CAT III/CAT IV shields may be removed for CAT II locations. This will allow testing on recessed conductors such as standard wall outlets. Take care not to lose the shields.

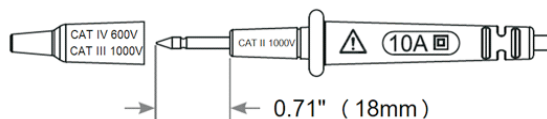

## X. Maintenance

**⚠ Warning:** Before opening the rear cover of the meter, remove the test leads to avoid electric shock.

### 1.General Maintenance

- 1) The maintenance and service must be implemented by qualified professionals or designated departments.
- 2) Clean the meter casing with a soft cloth and mild detergent. Do not use abrasives or solvents!

### 2.Battery Replacement (Picture 14)

- 1) Turn off the meter and remove the test leads from the input jacks.
- 2) Unscrew and remove the battery cover.
- 3) Replace with 3 standard AAA batteries according to the polarity indication.
- 4) Secure the battery cover and tighten the screw.

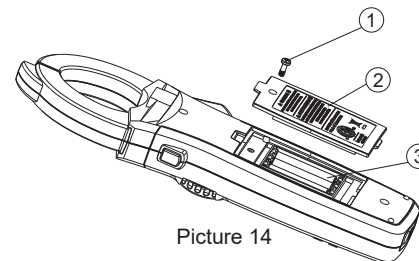

Picture 14

### 3.Test Lead Replacement

If the insulation on the test lead is damaged, replace it.

#### **⚠ Warning:**

Test leads used for MAINS measurement should meet EN 61010-031 standard, rated CAT III 1000V, 10A or better.

**UNI-T®****UNI-TREND TECHNOLOGY (CHINA) CO., LTD.**

No6, Gong Ye Bei 1st Road,  
Songshan Lake National High-Tech Industrial  
Development Zone, Dongguan City,  
Guangdong Province, China  
Tel: (86-769) 8572 3888  
<http://www.uni-trend.com>

