

UT125C Pocket Size Digital Multimeter User Manual

I. Introduction

UT125C is a palm-size, stable and reliable multimeter with 4000 display counts. It is an ideal tool to measure AC/DC voltage and current, resistance, capacitance, frequency, diode and continuity etc. with overload protection. This product complies with CAT III 600V and is granted with CE and cETLus certificates.

II. Open Box Inspection

Open the package box and take out the device. Please check whether the following items are deficient or damaged and contact your supplier immediately if they are.

- User manual -----1 pc
- Test leads-----1 pair

III. Safety Instructions

Safety Standards

- CE, cETLus

CONFORMS TO UL STD. 61010-1, 61010-2-030, 61010-2-033, 61010-031;
CERTIFIED TO CSA STD. C22.2 No. 61010-1, 61010-2-030, 61010-2-033, 61010-031.









- CAT III 600V, double insulation standard, over voltage standard, and RoHS, pollution grade II
- CAT III: It is applicable to test and measuring circuits connected to the distribution part of the building's low-voltage MAINS installation.

Safety Instructions

Please follow the instructions or the protection might be impaired.

- 1) Do not use the device if the rear cover is not covered up or it will pose a shock hazard
- 2) Functional dial should be switched to proper position.
- 3) Do not use the device if the device or test leads appear damaged or if you suspect that the device is not operating properly. Pay particular attention to the insulation layers.
- 4) The test leads should be properly inserted into the corresponding jack
- 5) Never input voltage and current exceeding the value listed on the device.
- 6) Do not switch the functional dial during measuring.
- 7) Use the replacement fuse of the specified model.
- 8) To avoid electric shock, potential difference between COM and the grounding shall not exceed 600V.
- 9) Use caution to measure voltage >DC 60V or AC 30Vrms.
- 10) To avoid false reading, replace the battery when the battery indicator  appears.
- 11) After measurement, switch off the device and remove the batteries if no use for long time.
- 12) Do not use or store the device in high temperature, high humidity, flammable, explosive or strong magnetic field environments.
- 13) Do not change the internal circuit of the device in order to avoid the damage to the device and users.
- 14) Use damp cloth to clean the case; do not use detergent containing solvents or abrasants.

IV. Symbols

	Low battery		Double insulation
	Buzzer		Warning
	Fuse	DC	Direct current
AUTO	Auto range		Diode
	Grounding		High voltage hazard
AC	Alternating current		Comply with European Union Standards

V. Features

- 1) LCD display:
Visible area: 38x23mm
Maximum display count: 4000
- 2) Overrange indication: OL, with overload protection
- 3) Auto power off. The device will automatically power off if no operation for 30 minutes. Press any button to wake up the device.
- 4) Operating temperature: 0°C~40°C (32°F~104°F)
- 5) Storage temperature: -10°C~50°C (14°F~122°F)
- 6) Low power indicator: 
- 7) Buzzer: The buzzer will go off once at any valid operation.
- 8) Other functions: Data hold, NCV, backlight

VI. Technical specifications

Accuracy: ± (% of reading + numerical value in least significant digit slot),

1 year warranty
Ambient temperature: 23°C ±5°C (73.4°F ±9°F)
Ambient humidity: ≤75% RH

Notes:

*. To ensure accuracy, operating temperature should be within 18°C ~ 28°C.

Temperature Coefficient= 0.1

* (specified accuracy)/°C (<18°C or >28°C)

1. DC voltage

Range	Resolution	Accuracy
400mV	0.1mV	± (1%+8)
4V	0.001V	± (0.5%+5)
40V	0.01V	
400V	0.1V	
600V	1V	± (0.8%+5)

▲ Input impedance: about 10MΩ.

▲ Overload protection: 600Vrms.

2. AC voltage

Range	Resolution	Accuracy
4V	0.001V	± (1.2%+5)
40V	0.01V	
400V	0.1V	
600V	1V	± (2.0%+10)

- ▲ Input impedance: about 10MΩ
- Frequency response: 45Hz~400Hz (Only for sine wave and triangle wave)
- Accuracy guarantee range: 5 ~100% of the range, shorted circuit allows least significant digit ≤5
- ▲ Overload protection: 600Vrms.
Display: Average value.

3. DC current

Range	Resolution	Accuracy
400μA	0.1μA	± (1.8%+5)
4mA	0.001mA	
40mA	0.01mA	
400mA	0.1mA	

- ▲ Overload protection: F1-500mA/600V Fuse
Maximum input current: 400mA
Measurement voltage drop: 400mV at full range

4. AC current

Range	Resolution	Accuracy
400μA	0.1μA	± (2.0%+8)
4mA	0.001mA	
40mA	0.01mA	
400mA	0.1mA	

- ▲ Overload protection: F1-500mA/600V Fuse
Frequency response: 45~400Hz (Only for sine wave and triangle wave)
Display: Average value
Accuracy guarantee range: 5 ~100% of the range, shorted circuit allows least significant digit ≤2
Maximum input current: 400mA
Measurement voltage drop: 400mV at full range

5. Resistance measurement.

Range	Resolution	Accuracy
400 Ω	0.1 Ω	± (1%+5)
4k Ω	1 Ω	
40k Ω	10 Ω	
400k Ω	100 Ω	± (1.2%+10)
4M Ω	1K Ω	
40M Ω	10K Ω	

- ▲ At 400Ω, measurement result = reading of resistor – reading of shorted test leads
Open circuit voltage=0.4V
- ▲ Overload protection: 600Vrms.

6. Capacitance

Range	Resolution	Accuracy
50nF	0.01nF	± (4.0%+30)
500nF	0.1nF	± (3%+15)
5μF	1nF	
50μF	10nF	
100μF	100nF	± (4.0%+10)



- ▲ Overload protection: 600Vrms
Range: Auto (There may be residual reading at open circuit, about 1100 digits)

7. Frequency

Range	Resolution	Accuracy
9.999Hz~60kHz	0.001Hz~0.01MHz	± (0.1%+5)

- ▲ Overload protection: 600Vrms
Input range: 5Vrms ≤ a ≤ 30Vrms Range: Auto

8. Continuity, Diode

Position	Remark
	Set Value: Open circuit: resistance ≥ 100Ω, no beep. Well-connected circuit: resistance ≤ 10Ω, continuous beeps. In open circuit, the voltage is about 1V.
	Display diode forward voltage value (Approximate value), range: 0~3V.

- ▲ Overload protection: 600Vrms
Diode open circuit voltage: 1.5V
Continuity voltage: 0.5V

9. NCV



Position	Remark
NCV	1.AC voltage 100V/50~60Hz
	2.Measurement distance ≤ 8mm; NCV LED on
	3.Measurement distance ≥ 80mm; NCV LED off
	4.8~80mm, NCV status unspecified.

VII. Operation instructions

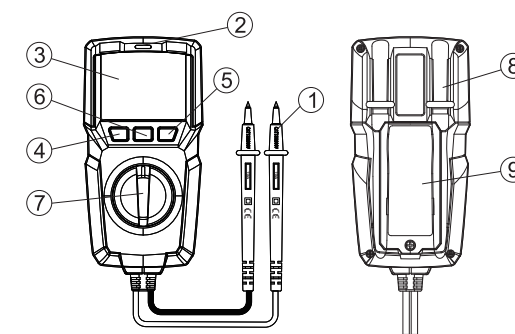
- To avoid false reading, replace the battery if the battery low power symbol appears.
- Pay special attention to the warning sign  besides the test lead housing, indicating that the tested voltage or current must not exceed the values listed on the device.
- Before measurement, switch the dial to proper position.
Structure: 1. Test leads; 2. NCV LED; 3. LCD display; 4. SELECT; 5. Frequency/duty ratio switch; 6. HOLD/Backlight; 7. Range selector; 8. Test leads slot; 9. Battery cover



1. DC voltage measurement

- 1) Switch the dial to 
- 2) Press  to select DC, Connect test leads with the load in parallel.
- 3) Reading is displayed.

Warnings:



- Do not input voltage over 600Vrms, or it may pose shock hazard.
- Be cautious when measuring high voltage

Note:

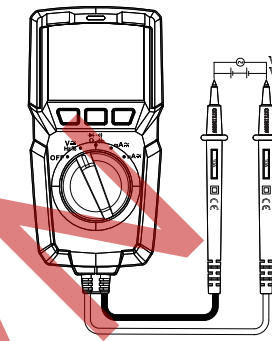
- Before using the device, it is suggested to measure a known voltage for verification.
- If LCD display shows OL, it means over range.
- When input impedance about 10MΩ, there is measurement errors. Input impedance ≤ 10kΩ, measurement errors can be ignored (≤ 0.1%)



2. AC voltage measurement

- 1) Switch the dial to 
- 2) Press  to select AC, Connect test leads with the load in parallel.
- 3) Reading is displayed.

Warnings:



- Do not input voltage over 600Vrms, or it may pose shock hazard.
- Be cautious when measuring high voltage

Note:

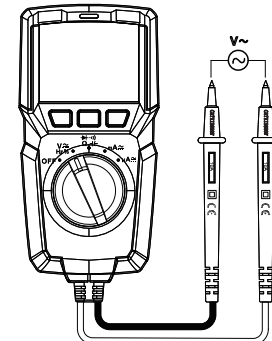
- Before using the device, it is suggested to measure a known voltage for verification.
- If LCD display shows OL, it means over range.
- When input impedance about 10MΩ, there is measurement errors. Input impedance ≤ 10kΩ, measurement errors can be ignored (≤ 0.1%)



3. DC current measurement



- 1) Switch the dial to  or 
- 2) Press  to select DC
- 3) Connect test leads with the circuit in series
- 4) Reading is displayed.

Notes:

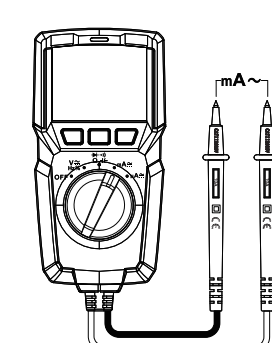
- Before measuring, switch off the power supply of the circuit.
- If connect test leads with the circuit in series, please power off the circuit in advance.
- If the range of the measured current is unknown, select the maximum range and then accordingly reduce.
- There are fuses inside mA/μA jack. Do not connect the test leads with any circuits in parallel.
- Under AC mode, readings are average value.
- If the OL appears on LCD display, it means over range. Please switch the range selector to higher range.
- Do not input current exceeding 400mA, or the fuse may be burnt.



4. AC current measurement

- 1) Switch the dial to  or 
- 2) Press  to select AC
- 3) Connect test leads with the circuit in series
- 4) Reading is displayed.

Notes:

- Before measuring, switch off the power supply of the circuit.
- If connect test leads with the circuit in series, please power off the circuit in advance.
- If the range of the measured current is unknown, select the maximum range and then accordingly reduce.
- There are fuses inside mA/μA jack. Do not connect the test leads with any circuits in parallel.
- Under AC mode, readings are average value.
- If the OL appears on LCD display, it means over range. Please switch the range selector to higher range.
- Do not input current exceeding 400mA, or the fuse may be burnt.

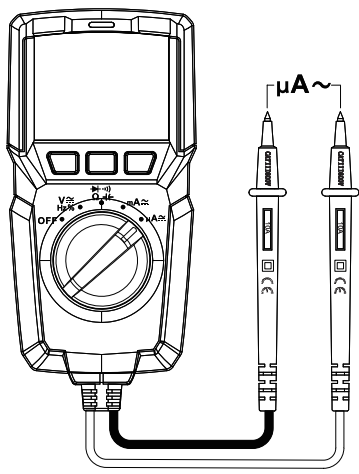

5. Resistance measurement.

- 1) Switch the dial to Ω .
- 2) Press \square to select resistance, Connect test leads with the load in parallel.
- 3) Reading is displayed.

Notes:

- If the resistor is open or over the range, the "OL" symbol will be displayed on the screen.
- Before measuring resistance, switch off the power supply of the circuit, and fully discharge all capacitors.
- When measuring low resistance, the test leads will produce $0.1\Omega \sim 0.2\Omega$ measurement error. To obtain accurate measurement, short the test leads, measurement value = displayed value - value when short circuited.
- When measuring high resistance above $1M\Omega$, it is normal to take a few seconds to steady the readings.

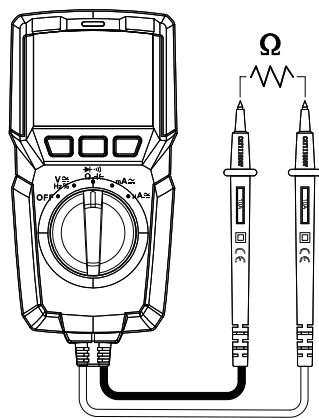

8. Diode measurement

- 1) Switch the dial to \rightarrow .
- 2) Press \square to select diode, connect test leads with the load in parallel.
- 3) Reading is displayed.
- 4) "OL" symbol appears when the diode is open or polarity is reversed. For silicon PN junction, normal value: $500 \sim 800mV$ ($0.5 \sim 0.8V$).

Warnings:

- Do not input over 60V DC or 30V AC or it will pose shock hazard.

Notes:

- Switch off the power supply to the circuit, and fully discharge all capacitors.
- Voltage for testing diode is about 1.5V.

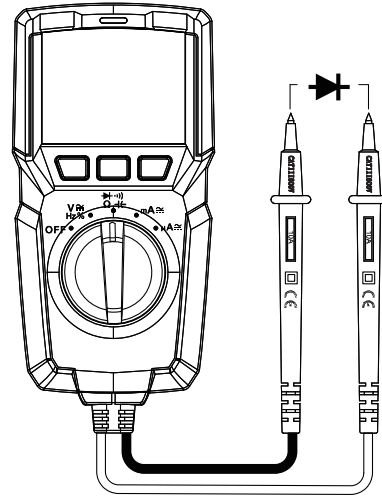

9. Continuity measurement

- 1) Switch the dial to \rightarrow .
- 2) Press \square to select continuity, connect test leads with the load in parallel.
- 3) Connect test leads with the load in parallel.
- 4) Reading is displayed. Measured resistance $>100\Omega$, circuit is in open status. Measured resistance $\leq 10\Omega$, circuit is in good conduction status, buzzer will go off

Warnings:

- Switch off the power supply to the circuit, and fully discharge all capacitors
- Do not input over 60V DC or 30V AC or it will pose shock hazard.

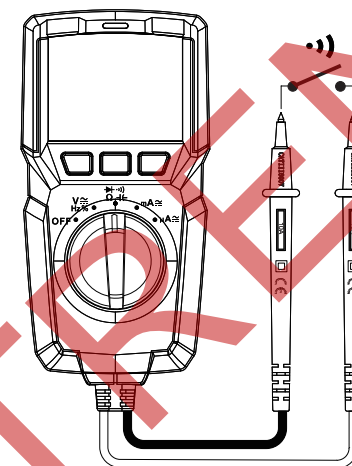

6. Capacitance measurement

- 1) Switch the dial to C .
- 2) Press \square to select capacitance, Connect test leads with the load in parallel.
- 3) Reading is displayed.

Notes:

- Switch off the power supply to the circuit, and fully discharge all capacitors
- Before measuring capacitors (especially for high voltage capacitors), please fully discharge them.
- If the tested capacitor is shorted or its capacity is over the specified range "OL" symbol will be displayed on the screen.
- When measuring large capacitors, it may take a few seconds to obtain steady readings. When there is no input, the device displays a fixed value (intrinsic capacitance).
- For small capacitance measurement, to ensure measurement accuracy, the measured value must be subtracted from intrinsic capacitance.

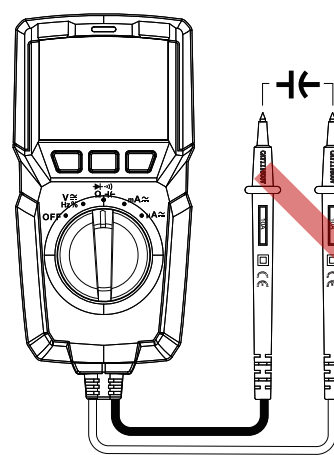

7. Frequency measurement

- 1) Switch the dial to voltage position, press \square button to select frequency
- 2) Connect the test leads to the load
- 3) Reading is displayed.

Warnings:

- Input value must meet the standards of the technical specifications.

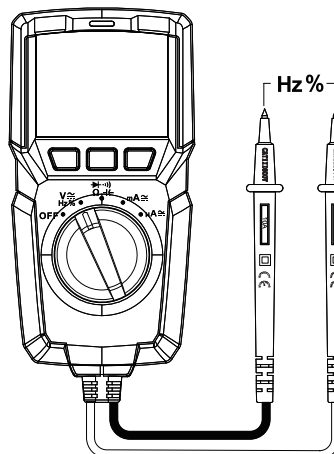

10. NCV measurement

- 1) Turn on the device; switch the range selector at any position.
- 2) Place the device near the measured object.
- 3) If the voltage under test exceeding 100V/50Hz, NCV LED will be on to indicate high voltage.

Warnings:

- NCV function is invalid to detect high voltage DC power supply
- Detection range is limited. If the distance is overrange, the voltage cannot be detected.
- No wire connection at this function.

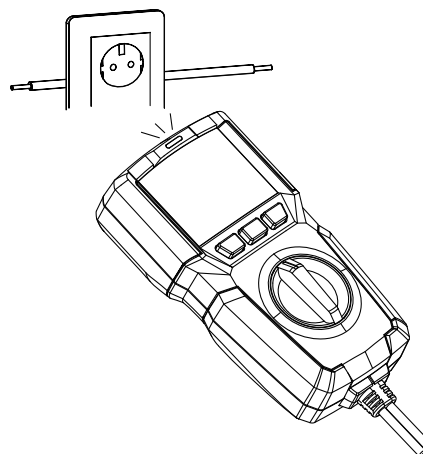

11. Buttons functions

SELECT : Cycle switch through AC/DC voltage, current, resistance, continuity, diode and capacitance. (Only for V_{AC} , I_{AC} , Ω)

HOLD : \square

- Press the button once to hold the reading. Press again to unlock the reading and enter general measurement modes.
- Press this button for 2 seconds to turn on the backlight. Press for 2 seconds to turn off the backlight.

Frequency/duty ratio

- Under voltage position, switch between frequency and duty ratio. Sequence: voltage-frequency-duty ratio
- Under current position, switch between frequency and duty ratio. Sequence: current-frequency-duty ratio

12. Others:

Auto power off:

- The device automatically shuts down if there is no operation for 30 minutes. You can wake up the device by pressing any key or turn off the device and restart it. Buzzer notification: Buzzer goes off once at any valid operation.

VIII. Maintenance

Warning: Before opening the rear cover, switch off the power supply (remove test leads from the input terminal and the circuit).

1. General maintenance

- 1) Clean the case with a damp cloth and detergent. Do not use abrasives or solvents
- 2) If there is any malfunction, stop using the device and send it to maintenance.
- 3) The maintenance and service must be implemented by qualified professionals or designated departments.

2. Replacements

Battery replacement:

To avoid false reading, replace the battery when the battery indicator \square appears.

Battery Specification: AAA 1.5V x 2

- 1) Switch the dial to "OFF" position and remove the test leads from the input terminal.
- 2) Take off the protective case. Loosen 1 screw on battery cover; remove the cover to replace the battery. Please identify the positive and negative pole.

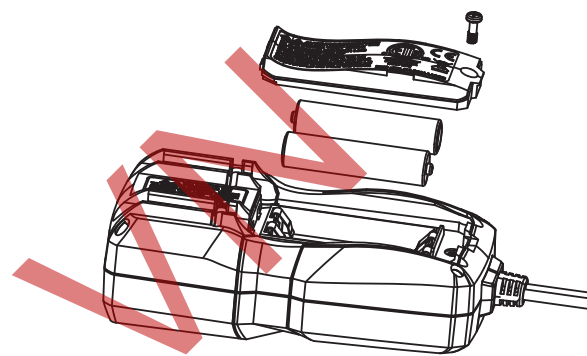

Fuse replacement:

F1 Fuse $\Phi 6 \times 32mm$ FF500mA H 600V

- 1) Switch the dial to "OFF" position and remove the test leads from the input terminal
- 2) Loosen the 1 screw on the battery cover, and then remove the rear cover, and loosen 5 screws of the rear cover to replace the fuse Fuse specification

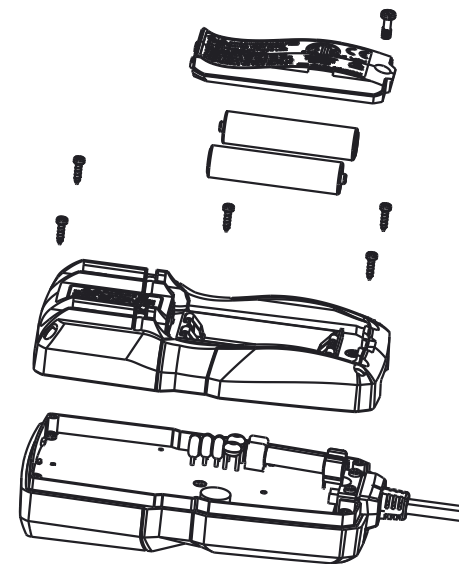

UNI-T

UNI-TREND TECHNOLOGY (CHINA) CO., LTD.

No.6, Gong Ye Bei 1st Road,
Songshan Lake National High-Tech Industrial
Development Zone, Dongguan City,
Guangdong Province, China
Tel: (86-769) 8572 3888
<http://www.uni-trend.com>