

User's Manual

MSO/UPO3000E Series Digital Oscilloscope

Foreword

Dear Users,

Hello! Thank you for choosing this brand new UNI-T instrument. In order to use this instrument safely and

correctly, please read this manual thoroughly, especially the Safety Requirements part.

After reading this manual, it is recommended to keep the manual at an easily accessible place, preferably close to the device, for future reference.

Copyright Information

Uni-Trend Technology (China) Co., Ltd. All rights reserved.

Trademark Information

UNI-T is the registered trademark of Uni-Trend Technology (China) Co., Ltd.

Document Version

MSO/UP03000E20231106-V2.04

Statement

- UNI-T products are protected by patent rights in China and foreign countries, including issued and pending patents.
- UNI-T reserves the rights to any product specification and pricing changes.
- UNI-T reserves all rights. Licensed software products are properties of Uni-Trend and its subsidiaries or suppliers, which are protected by national copyright laws and international treaty provisions. Information in this manual supersedes all previously published versions.
- Technical data subject to change without notice.

Warranty

UNI-T warrants that the product will be free from defects for a one-year period. If the product is re-sold, the warranty period will be from the date of the original purchase from an authorized UNI-T distributor. Probes, other accessories, and fuses are not included in this warranty.

If the product is proved to be defective within the warranty period, UNI-T reserves the rights to either repair the defective product without charging of parts and labor, or exchange the defected product to a working equivalent product. Replacement parts and products may be brand new, or perform at the same specifications as brand new products. All replacement parts, modules, and products become the property of UNI-T.

The "customer" refers to the individual or entity that is declared in the guarantee. In order to obtain the warranty service, "customer" must inform the defects within the applicable warranty period to UNI-T, and to perform appropriate arrangements for the warranty service. The customer shall be responsible for packing and shipping the defective products to the designated maintenance center of UNI-T, pay the shipping cost, and provide a copy of the purchase receipt of the original purchaser. If the product is shipped domestically to the location of the UNI-T service center, UNI-T shall pay the return shipping fee. If the product is sent to any other location, the customer shall be responsible for all shipping, duties, taxes, and any other expenses.

This warranty shall not apply to any defects or damages caused by accidental, machine parts' wear and tear, improper use, and improper or lack of maintenance. UNI-T under the provisions of this warranty has no obligation to provide the following services:

- a) Any repair damage caused by the installation, repair, or maintenance of the product by non UNI-T service representatives.
- b) Any repair damage caused by improper use or connection to an incompatible device.
- c) Any damage or malfunction caused by the use of a power source which does not conform to the requirements of this manual.
- d) Any maintenance on altered or integrated products (if such alteration or integration leads to an increase in time or difficulty of product maintenance).

This warranty is written by UNI-T for this product, and it is used to substitute any other express or implied warranties. UNI-T and its distributors do not offer any implied warranties for merchant ability or applicability purposes.





For violation of this guarantee, regardless of whether UNI-T and its distributors are informed that any indirect, special, incidental, or consequential damage may occur, UNI-T and its distributors shall not be responsible for any of the damages.











1. Introduction

This manual includes safety requirements, installment and the operation of MSO/UP03000E oscilloscope.

2. Safety Requirements

This section contains information and warnings that must be followed to keep the instrument operating under safety conditions. In addition, user should also follow the common safety procedures.

Safety Precautions		
Warning	Please follow the following guidelines to avoid possible electric shock and risk to personal safety.	
	Users must follow the following conventional safety precautions in operation, service and maintenance of this device. UNI-T will not be liable for any personal safety and property loss caused by the user's failure to follow the following safety precautions. This device is designed for professional users and responsible organizations for measurement purposes. Do not use this device in any way not specified by the manufacturer. This device is only for indoor use unless otherwise specified in the product manual.	
Safety Statement		
Warning	"Warning" indicates the presence of a hazard. It reminds users to pay attention to a certain operation process, operation method or similar. Personal injury or death may occur if the rules in the "Warning" statement are not properly executed or observed. Do not proceed to the next step until you fully understand and meet the conditions stated in the "Warning" statement.	
Caution	"Caution" indicates the presence of a hazard. It reminds users to pay attention to a certain operation process, operation method or similar. Product damage or loss of important data may occur if the rules in the "Caution" statement are not properly executed or observed. Do not proceed to the next step until you fully understand and meet the conditions stated in the "Caution" statement.	
Note	"Note" indicates important information. It reminds users to pay attention to procedures, methods and conditions, etc. The contents of the "Note" should be highlighted if necessary.	
Safety Sign		
	Danger	It indicates possible danger of electric shock, which may cause personal injury or death.
	Warning	It indicates that you should be careful to avoid personal injury or product damage.
	Caution	It indicates possible danger, which may cause damage to this device or other equipment if you fail to follow a certain procedure or condition. If the "Caution" sign is present, all conditions must be met before you proceed to operation.
	Note	It indicates potential problems, which may cause failure of this device if you fail to follow a certain procedure or condition. If the "Note" sign is present, all conditions must be met before this device will function properly.
	AC	Alternating current of device. Please check the region's voltage range.

	DC	Direct current device. Please check the region's voltage range.
	Grounding	Frame and chassis grounding terminal.
	Grounding	Protective grounding terminal.
	OFF	Main power off.
	ON	Main power on.
	Power Supply	Standby power supply: when the power switch is turned off, this device is not completely disconnected from the AC power supply.
CAT I		Secondary electrical circuit connected to wall sockets through transformers or similar equipment, such as electronic instruments and electronic equipment; electronic equipment with protective measures, and any high-voltage and low-voltage circuits, such as the copier in the office
CAT II		CATII: Primary electrical circuit of the electrical equipment connected to the indoor socket via the power cord, such as mobile tools, home appliances, etc. Household appliances, portable tools (e.g. electric drill), household sockets, sockets more than 10 meters away from CAT III circuit or sockets more than 20 meters away from CAT IV circuit
CAT III		Primary circuit of large equipment directly connected to the distribution board and circuit between the distribution board and the socket (three-phase distributor circuit includes a single commercial lighting circuit). Fixed equipment, such as multi-phase motor and multi-phase fuse box; lighting equipment and lines inside large buildings; machine tools and power distribution boards at industrial sites (workshops)
CAT IV		Three-phase public power unit and outdoor power supply line equipment. Equipment designed to "initial connection", such as power distribution system of power station, power instrument, front-end overload protection, and any outdoor transmission line
	Certification	CE indicates a registered trademark of EU
	Certification	UKCA indicates a registered trademark of UK
	Certification	Conforms to UL STD 61010-1, 61010-2-030, Certified to CSA STD C22.2 No. 61010-1, 61010-2-030.
	Waste	Do not place equipment and its accessories in the trash. Items must be properly disposed of in accordance with local regulations.
	EFUP	This environment-friendly use period (EFUP) mark indicates that dangerous or toxic substances will not leak or cause damage within this indicated time period. The environment-friendly use period of this product is 40 years, during which it can be used safely. Upon expiration of this period, it should enter the recycling system.

Safety Requirements	
Warning	
Preparation before use	<p>Please connect this device to AC power supply with the power cable provided;</p> <p>The AC input voltage of the line reaches the rated value of this device. See the product manual for specific rated value.</p> <p>The line voltage switch of this device matches the line voltage;</p> <p>The line voltage of the line fuse of this device is correct;</p> <p>It not used for measuring the main circuit.</p>
Check all terminal rated values	Please check all rated values and marking instructions on the product to avoid fire and impact of excessive current. Please consult the product manual for detailed rated values before connection.
Use the power cord properly	You can only use the special power cord for the instrument approved by the local and state standards. Please check whether the insulation layer of the cord is damaged or the cord is exposed, and test whether the cord is conductive. If the cord is damaged, please replace it before using the instrument.
Instrument Grounding	To avoid electric shock, the grounding conductor must be connected to the ground. This product is grounded through the grounding conductor of the power supply. Please be sure to ground this product before it is powered on.
AC power supply	Please use the AC power supply specified for this device. Please use the power cord approved by your country and confirm that the insulation layer is not damaged.
Electrostatic prevention	This device may be damaged by static electricity, so it should be tested in the anti-static area if possible. Before the power cable is connected to this device, the internal and external conductors should be grounded briefly to release static electricity. The protection grade of this device is 4 kV for contact discharge and 8 kV for air discharge.
Measurement accessories	Measurement accessories are of lower class, which are definitely not applicable to main power supply measurement, CAT II, CAT III or CAT IV circuit measurement. Probe subassemblies and accessories within the range of IEC 61010-031 and current sensor within the range of IEC 61010-2-032 can meet its requirements.
Use the input / output port of this device properly	Please use the input / output ports provided by this device in a properly manner. Do not load any input signal at the output port of this device. Do not load any signal that does not reach the rated value at the input port of this device. The probe or other connection accessories should be effectively grounded to avoid product damage or abnormal function. Please refer to the product manual for the rated value of the input / output port of this device.
Power fuse	Please use power fuse of specified specification. If the fuse needs to be replaced, it must be replaced with another one that meets the specified specifications (Class T, rated current 5A, rated voltage 250V) by the

	maintenance personnel authorized by UNI-T.
Disassembly and cleaning	There are no components available to operators inside. Do not remove the protective cover. Maintenance must be carried out by qualified personnel.
Service environment	This device should be used indoors in a clean and dry environment with ambient temperature from 0 °C to 40 °C. Do not use this device in explosive, dusty or humid air.
Do not operate in humid environment	Do not use this device in a humid environment to avoid the risk of internal short circuit or electric shock.
Do not operate in flammable and explosive environment	Do not use this device in a flammable and explosive environment to avoid product damage or personal injury.
Caution	
Abnormality	If this device may be faulty, please contact the authorized maintenance personnel of UNI-T for testing. Any maintenance, adjustment or parts replacement must be done by the relevant personnel of UNI-T.
Cooling	Do not block the ventilation holes at the side and back of this device; Do not allow any external objects to enter this device via ventilation holes; Please ensure adequate ventilation, and leave a gap of at least 15 cm on both sides, front and back of this device.
Safe transportation	Please transport this device safely to prevent it from sliding, which may damage the buttons, knobs or interfaces on the instrument panel.
Proper ventilation	Poor ventilation will cause the device temperature to rise, thus causing damage to this device. Please keep proper ventilation during use, and regularly check the vents and fans.
Keep clean and dry	Please take actions to avoid dust or moisture in the air affecting the performance of this device. Please keep the product surface clean and dry.
Note	
Calibration	The recommended calibration period is one year. Calibration should only be carried out by qualified personnel.

2.1 Environmental Requirements

This instrument is suitable for the following environment:

- Indoor use
- Pollution degree 2
- In operating: altitude lower than 3000 meters; in non-operating: altitude lower than 15000 meters
- Unless otherwise specified, operating temperature is 0 to +40°C; storage temperature is -20 to + 70°C
- In operating, humidity temperature below to +35°C, ≤90% relative humidity;

In non-operating, humidity temperature +35°C to +40°C, ≤60% relative humidity

There are ventilation opening on the rear panel and side panel of the instrument. So please keep the air flowing through the vents of the instrument housing. To prevent excessive dust from blocking the vents, please clean the instrument housing regularly. The housing is not waterproof, please disconnect the power supply first and then wipe the housing with a dry cloth or a slightly moistened soft cloth.

2.2 Connecting Power Supply

The specification of input AC power.

Voltage Range	Frequency
100V~240VACrms (fluctuant: ±10%)	50/60Hz

Please use the attached power lead to connect to the power port.

Connecting to service cable

This instrument is a Class I safety product. The supplied power lead has good performance in terms of case ground. This spectrum analyzer is equipped with a three-prong power cable that meets international safety standards. It provides good case grounding performance for the specification of your country or region.

Please install AC power cable as follows:

- Ensure the power cable is in a good condition.
- Leave enough space for connecting the power cord.
- Plug the attached three-prong power cable into a well-grounded power socket.

2.3 Electrostatic Protection

Electrostatic discharge may cause damage to component. Components can be damaged invisibly by electrostatic discharge during transportation, storage and use.

The following measure can reduce the damage of electrostatic discharge:

- Testing in anti-static area as far as possible.
- Before connecting the power cable to the instrument, inner and outer conductors of the instrument should be briefly grounded to discharge static electricity.
- Ensure all the instruments are properly grounded to prevent the accumulation of static.

3. Introduction of MSO/UP03000E Series

MSO/UP03000E series digital phosphor oscilloscope includes ten models

Model	Analog Channel	Analog bandwidth	LA	AWG
UP03354E	4	350MHz	○	×
UP03352E	2	350MHz	○	×
UP03504E	4	500MHz	○	×
UP03502E	2	500MHz	○	×
MS03354E	4	350MHz	●	×
MS03352E	2	350MHz	●	×
MS03504E	4	500MHz	●	×
MS03502E	2	500MHz	●	×
MS03354E-S	4	350MHz	●	●
MS03504E-S	4	500MHz	●	●

●: Standard ○: Optional ×: Not support

MSO/UP03000E series digital phosphor oscilloscope is based on unique Ultra Phosphor 2.0 technology. A multi-functional, high performance oscilloscope that is easy to use, with excellent technical specifications, a perfect combination of many functionalities that can help users to quickly complete testing. MSO/UP03000E series is aimed at satisfying the most extensive oscilloscope markets, including communications, semiconductors, computers, meter and instruments, industrial electronics, consumer electronics, automotive electronics, field maintenance, R&D, education, etc.

Main Features

- ✧ Analog channel bandwidth: 500 MHz, 350 MHz
- ✧ Analog channel with real-time sampling rate 2.5 GSa/s, digital channel with real-time sampling rate 1.25 GSa/s (only for MSO)
- ✧ Input resistance: 1 M Ω and 50 Ω
- ✧ Storage depth for all the of channels is 70 Mpts, the maximum of storage depth of single or sweep mode is 250Mpts
- ✧ Waveform capture rate of up to 1,000,000 wfms/s
- ✧ Build in 50 MHz double channel function/arbitrary waveform generator (only for MSO-S), it supports loading data on the screen of the oscilloscope into AWG arbitrary waveform output in real-time
- ✧ Bode Plot loop test analysis function
- ✧ Up to 120,000 frames of hardware real-time waveform continuous recording and analysis function and support USB storage device export
- ✧ Waveform operation: add, subtract, multiply, divide, digital filter, logical operation and advanced operation
- ✧ 1M point enhance FFT, support frequency setting, waterfall curve, detection setting and mark measurement
- ✧ Automatic measurement of 36 waveform parameters
- ✧ Multi-Scopes 2.0 supports multiple channels independent trigger fluorescent display
- ✧ Multiple channels with independent hardware 7 digits frequency meter
- ✧ DVM supports multiple channels independent AC/DC TRMS (true virtual value) measurement
- ✧ Analog channel: 2 or 4 channel for selection, standard 56Mpts storage depth for each of channels
- ✧ Abundant trigger functions: edge, pulse width, video, slope, runt pulse, over-amplitude pulse, delay, timeout, duration, setup hold, Nth edge and pattern trigger
- ✧ Region trigger function for capturing occasional signal and observing complex signal
- ✧ Protocol trigger and decoding function (optional): RS232, I2C, SPI, CAN, CAN-FD, LIN, FlexRay
- ✧ Ultra Phosphor 2.0 display effect with 256 level gray scale display
- ✧ 8 inch high-definition capacitive touch (800×480) screen, support gesture operating click, slide, zoom, edit and drag
- ✧ Multiple peripheral interface: USB Host, USB Device, LAN, EXT Trig, AUX Out (Trig Out, Pass/Fail), AWG output and VGA
- ✧ Supporting USB storage and upgrade, one-key print screen
- ✧ Supporting USB to communicate with PC
- ✧ Supporting SCPI programmable standard command
- ✧ Support WEB access and control

4. Getting Started Guide

This chapter introduces on using the oscilloscope for the first time, the front and rear panels, the user interface, as well as the built-in help system.

- General Inspection
- Before Use
- Front Panel
- Rear Panel
- Operation Panel
- User Interface
- Touch Screen
- Special Symbol

4.1 General Inspection

It is recommended to inspect the instrument follow the steps below before using the MSO/UP03000E series for the first time.

(1) Check for Damages caused by Transport

If the packaging carton or the foam plastic cushions are severely damaged, please contact the UNI-T distributor of this product immediately.

(2) Check Attachment

Please check appendix for the list of accessories. If any of the accessories are missing or damaged, please contact UNI-T or local distributors of this product.

(3) Machine Inspection



If the instrument appears to be damaged, not working properly, or has failed the functionality test, please contact UNI-T or local distributors of this product.

If the equipment is damaged due to shipping, please keep the packaging and notify both the transportation department and UNI-T distributors, UNI-T will arrange maintenance or replacement.

4.2 Before Use

To perform a quick verification of the instrument's normal operations, please follow the steps below:

(1) Connect to the Power Supply

The power supply voltage range is from 100 VAC to 240 VAC, the frequency range is 50 Hz to 60 Hz. Connect the oscilloscope to the power supply line that came with the oscilloscope or any power supply line that meets the local country standards. If the power switch on the rear panel is not turned on, the indicator of power soft button  on the left corner on the front panel will be extinguished and no function. If the power switch on the rear panel is turned on, the indicator of power soft button  on the left corner on the front panel will be on red, press this button to boot-up the instrument.

(2) Boot-up Check

Press the soft power button  and the light should change to green. The oscilloscope will show a boot animation, and then enter the normal interface.

(3) Connect Probe

Use probe's BNC port connect to the channel 1 BNC port of the oscilloscope. Connect the probe to the "Compensating signal port" and the ground clip is connected to the "Ground terminal" below the compensating signal port as shown in Figure 4-1. The output of the compensating signal should be amplitude 3 Vpp, default frequency is 1 kHz

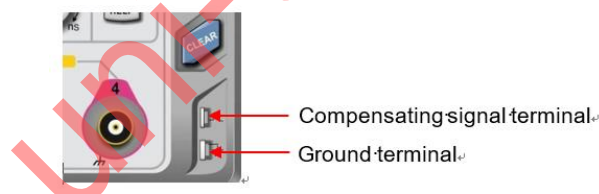

Figure 4-1 Compensating signal and Ground terminal

(4) Function Check

Press the AUTO key, a 3 Vpp 1 kHz square wave should appear. Repeat step 3 to check all of the channels.

(5) Probe Compensation

When the probe is connected to any input channel for the first time, this step might be adjusted in order to match the probe and the input channel. Probes that are not compensated may lead to measurement errors or mistake. If need to adjust the probe compensation, please follow the following steps:

- Set the attenuation coefficient in the probe menu and the switch on the probe 10x, and connect the probe to CH1. Make sure the probe's connector is properly connected with the oscilloscope. Connect the probe's main clip and ground clip to the oscilloscope's compensating signal and ground terminal respectively. Open CH1 and press the AUTO button.

- View the displayed waveform, as shown in Figure 4-2.

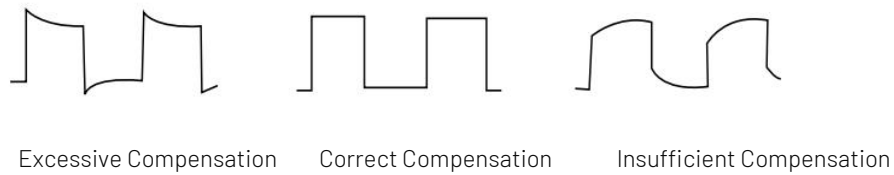

Figure 4-2 Compensating Calibration of Probe

- If the displayed waveform is look like the above "Insufficient Compensation" or "Excessive Compensation", use a non-metallic screwdriver to adjust the probe's variable capacitance until the display matches the "Correct compensation" waveform.

Warning: To avoid electric shock when using the probe to measure high voltage, please ensure that the probe insulation is in good condition and avoid physical contact with any metallic part of the probe.

4.3 Front Panel

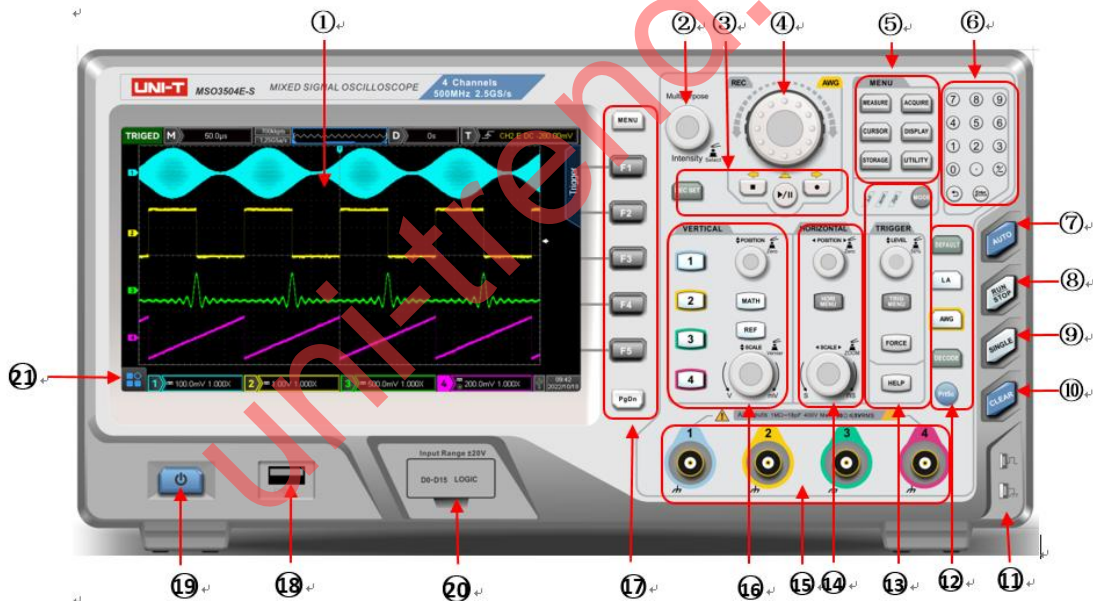

Figure 4-3 Front Panel

- Screen display area
- Multipurpose knob
- Recording waveform
- Jog dial knob
- Function menu
- Numeric keypad
- Automatic control key
- Run/Stop control key
- Single trigger control key
- Clear all control key

11. Compensating signal connector and ground terminal
12. Factory setting, LA (16 digital channels), AWG (function/arbitrary waveform generator), protocol decoding, print screen key
13. Trigger control (TRIGGER)
14. Horizontal control (HORIZONTAL)
15. Analog channel input port
16. Vertical control (VERTICAL)
17. Menu control soft key
18. USB HOST interface
19. Power soft key
20. Digital channel input port
21. HOME Menu

4.4 Rear Panel

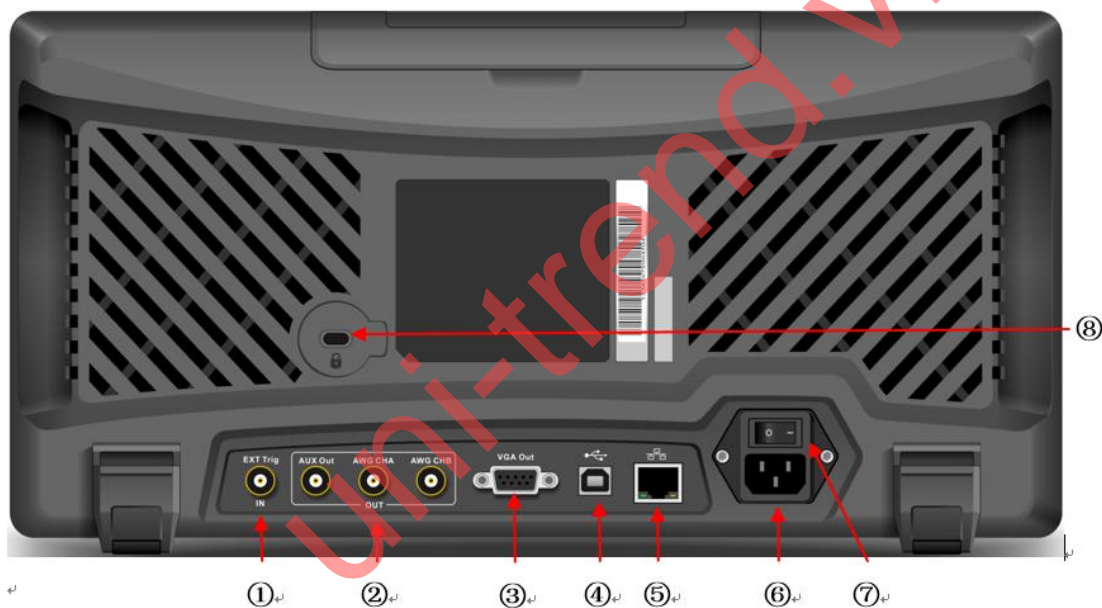
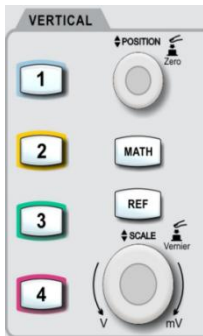

Figure 4-4 Rear Panel

1. EXT Trig: Input port of external trigger or external trigger /5
2. OUT: Output port supports AUX Out, AWG CHA and AWG CHB for function/arbitrary waveform generator
3. VIDEO Out: VGA video signal output, it can convert screen to VGA output
4. USB Device: USB device interface, use this interface to communicate with PC
5. LAN: Use this interface to connect the oscilloscope to local area network for remote control
6. AC Power Input Socket: AC power input port. Use power cord supplied with accessory to connect the oscilloscope to AC power (power supply requirements of this oscilloscope 100~240 V, 45~440 Hz)
7. Power Switch: Turn on power switch after AC socket is connect properly, the oscilloscope can be power on normally. Press "power soft key" on the front panel to boot-up the oscilloscope
8. Safety Lock: Safety lock (sold separately) can be used for the oscilloscope stay at fixed position

4.5 Operation Panel

(1) Vertical Control



- 1, 2, 3, 4 : Analog channel setting key, it represents CH1, CH2, CH3, CH4 separately. Four channel identified by different colors and the color also corresponding to waveform on the screen and channel input connector. Press any key to turn on the related channel menu (to activate or disable the channel).
- MATH: Press this key to open the mathematical operation menu for add, subtract, multiply, divide, FFT, digital filtering and advanced operations.
- REF: For recall reference waveform stored in "internal or U flash dish". It can compare the actual measured waveform with reference waveform.
- Vertical POSITION: Vertical position knob is used for move the vertical position of the current channel waveform. The vertical displacement value will display at the baseline cursor **240.00mV**. Press this knob to return the channel display back to the vertical midpoint.
- Vertical SCALE: Vertical position knob is used for adjusting the vertical scale, turn clockwise to decrease the scale, turn counterclockwise to increase the scale. With this process, waveform will display increasing or decreasing and position information **1 = 100V IX** will also be presented in real-time. The vertical scale stepped as 1-2-5 order. Press the knob allows the vertical adjustment to switch coarse and fine adjustment mode.

(2) Horizontal Control



- HORIZ MENU: Horizontal menu is for display window extension, Multi-Scopes, time base (XY/YT) and trigger holdoff.
- Horizontal POSITION: The trigger point moves around the left or right of the center of the screen when adjusting the horizontal position knob. And the waveform of all the channel moves to left or right. Horizontal position parameter **D >> 0s** will display on the top of the screen in real-time. Press this knob to return the channel display back to the midpoint position.
- Horizontal SCALE: The trigger point moves around the left or right of the center of the screen when adjusting the horizontal scale knob. And horizontal displacement value **M >> 1.00ms** on the top of the screen will change in real-time. Press this knob to return the channel display back to the midpoint position. The time base scale stepped as 1-2-5 order. Press the knob to switch main window and extension window.

(3) Trigger Control



- MODE: Press this key to switch mode to Auto, Normal or Single. The backlight corresponding to the current trigger mode will turn on.
- LEVEL: Trigger level adjusting knob. Turn clockwise to increase the level and turn counterclockwise to decrease the level. During the adjustment, the trigger level at the top right corner of the screen **T E/DC 0.000µV** will change in real-time.

Press

this knob to quickly reset the trigger level back to 50% trigger signal position.

- TRIG MENU: Press to display trigger menu. For more details refer to [Trigger System](#).
- FORCE: Force trigger key. In Normal, Single trigger mode, press this key to force a trigger.
- HELP: Press to display built-in help system of the oscilloscope.

(4) Automatic Setting



Press this key, the oscilloscope will automatically adjust the vertical scale, scan time base and trigger mode according to the input signal to realize optimum waveform display.

Note: Waveform auto setting function requires that the frequency of sine is no lower than 20 Hz; the amplitude must be at least 20 mVpp~120 Vpp. Otherwise, the waveform auto setting function may be invalid.

(5) Run/Stop



Press this key set the operating state to "RUN" or "STOP".

In the "RUN" state, the key is illuminated in green.

In the "STOP" state, the key is illuminated in red.

(6) Single Trigger



Press this key to set trigger mode to "Single", the key is illuminated in orange.

(7) Clear All



Press this key to clear all the recalled waveform on the screen. If the oscilloscope is in RUN state, then keep display new waveform.

(8) PrintScreen



Press this key to save waveform as PNG format image and quick copy into USB device.

(9) Multipurpose Knob



Multipurpose: In menu operating, press the soft key of a menu and rotate the knob to select a submenu under the menu. Then press the knob (that is, the select function) to select the currently selected submenu.

(10) Jog Dial Knob



For numerical parameter that the setting range is large, this knob can be used to quick adjustment. Rotate clockwise (anticlock wise) to increase (decrease) numerical value; inner layer can be fine tuning, outer layer can be coarse tuning. Such as, rotate this knob

to quickly locate the waveform frame that need to recall. This knob also can be used to set parameter like trigger holdoff time, pulse width setting and slope time.

(11) Function Key



- **MEASURE**: Press this key to enable the measurement setting menu. It can set the measurement source, all parameter measurement, user-defined parameter, measurement statistic and measure indicator. Turn on user-defined, it has 36 types of parameter measurement. Press Multipurpose knob to quick select parameter to measuring and the result will show on the bottom of the screen.
- **ACQUIRE**: Press this key to enter sampling setting menu. It can set sampling mode and depth storage and quick sampling.
- **CURSOR**: Press this key to enter cursor measurement menu. It can set time or voltage parameter of cursor measuring waveform by manual.
- **DISPLAY**: Press this key to enter display setting menu. It can set waveform display type, grid type, grid brightness, waveform brightness, background brightness, persistence, color temperature, anti-color temperature, pop-up window transparency and default transparency.
- **STORAGE**: Press this key to enter storage menu, storage type includes setting, waveform, arbitrary waveform and picture. It can stored in the oscilloscope or external USB storage device.
- **UTILITY**: Press this key to enter auxiliary function menu. It can set auto-calibration, system information, language setting, interface setting, recording waveform, pass/fail test, square waveform, frequency meter, output selection, auto-setting, clear data, SCPI setting, IP setting, time setting, upgrade, bode diagram, boot loading, power on mode and chip selection.

(12) Numeric Keypad



For numerical parameter that the setting range is large, numeric keypad can input digit with time unit, voltage unit directly. If the parameter is no unit, then press **Enter** key to confirm.

(13) Recording Waveform

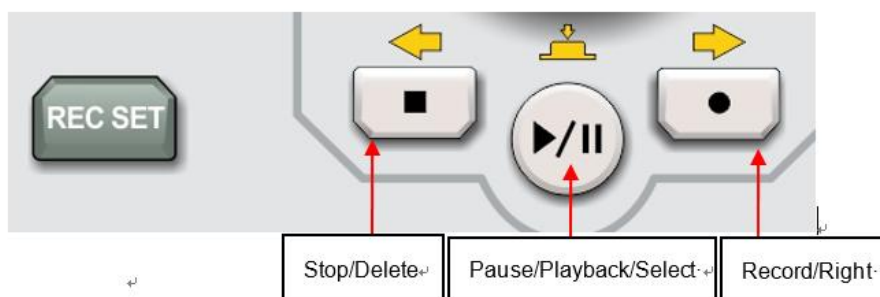

- ① **REC SET**: Recording waveform setting menu, it can set recording interval, end frame, play delay, the maximum frame setting or display.
- ② **Stop**: Press this key to stop recording or playback waveform.
- ③ **Playback/Pause**: In stop or pause state, press this key to playback waveform, press it again to

pause playback.

- ④ **Record**: Press this key to start recording waveform.

(14) HOME Menu

Tap HOME icon to pop out HOME shortcut menu list (as show in Figure 4-5), which includes cursor, mathematical operation, spectrum analysis, recording waveform, pass/fail test, reference waveform, decoding, bode diagram, drawing rectangle, frequency meter, voltmeter, and help menu. Through this shortcut menu, user can quickly find and enter the function module.

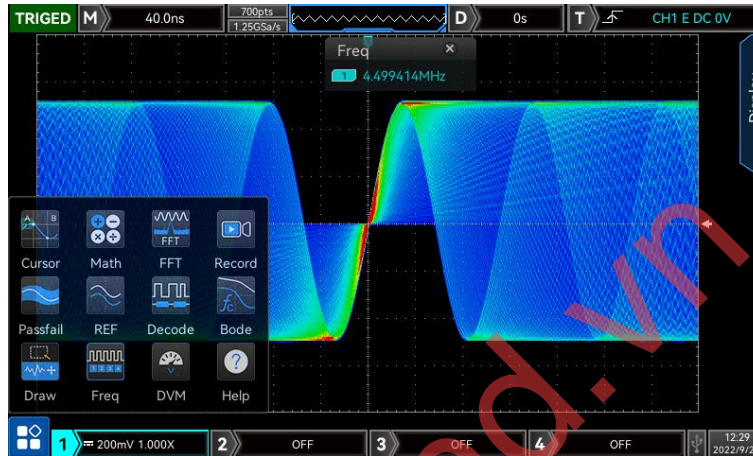

Figure 4-5

4.6 User Interface

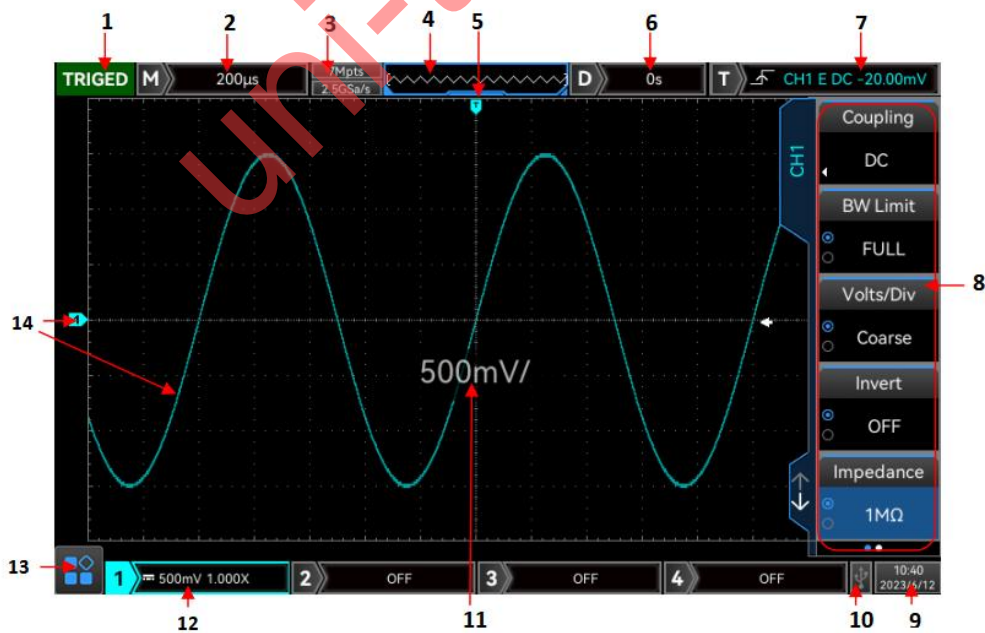

Figure 4-6

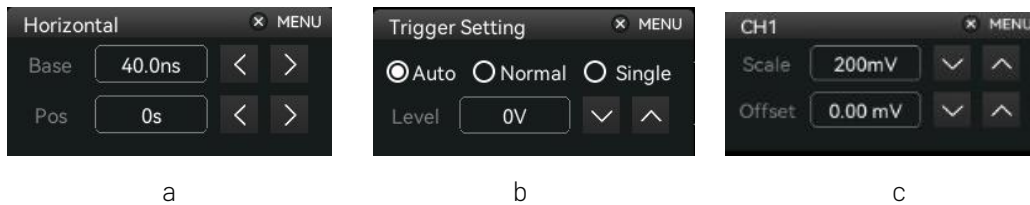



Figure 4-7

User interface as shown in Figure 4-6 and the detailed description see the following.

- ① Trigger status identification: TRIGED (has been triggered), AUTO, READY, STOP, and ROLL.
- ② Time base scale: Indicates the amount of time represented by one grid, which can be adjusted by SCALE knob on the horizontal control area, a time base scale will pop up on the screen when the time base scale changes. Tap time base scale to pop out horizontal interface as show in Figure 4-7(a), time base scale can change by using numeric keypad, **<**, **>** and SCALE knob .
- ③ Sampling rate/storage depth: Display sampling rate and storage depth of the current scale.
- ④ Waveform indicator
- ⑤ Waveform trigger position: Display the trigger position of the current waveform.
- ⑥ Horizontal displacement: Display the horizontal displacement value of waveform. Change this parameter by using POSITION knob on horizontal control area. Press POSITION knob on horizontal control area to make horizontal displacement value turn to 0. Tap time base scale to pop out horizontal interface as show in Figure 4-7(a), horizontal displacement value can change by using numeric keypad, **<**, **>** and POSITION knob.
- ⑦ Trigger status: Display the current trigger source, type, slope, coupling and level status.
 - a. Trigger source: There are CH1~CH4, main electricity, EXT, EXT/5 and D0-D15 status. CH1~CH4 will display different trigger state colors based on channel colors.
 - b. Trigger type: The types are edge, pulse width, video, slope, and advanced trigger. For example, **E** represents edge trigger.
 - c. Trigger edge: The types are rising, falling, and random. For example, **↑** represents rising edge trigger.
 - d. Trigger coupling: The types are DC, AC, HF rejection, LF rejection and noise rejection. For example, **DC** indicates DC coupling.
 - e. Trigger level: Display the current trigger level value, it corresponding to the right side of screen **1**. Change this parameter by using LEVEL knob on trigger control area.
 - f. Tap trigger status area to pop out trigger setting interface as shown in Figure 4-7(b). Trigger level value and trigger coupling mode can change by using numeric keypad, **↓**, **↑** and LEVEL knob.
- ⑧ Operation menu: Display the current operation menu, press the corresponding key to change the menu. Press F1 ~ F5 to select the corresponding submenu.
- ⑨ Set year, month, date and time in Utility menu or tap this area to pop out time setting interface to setup.
- ⑩ USB DEVICE icon: This icon will appear when USB DEVICE connect with the instrument.
- ⑪ Pop-up window : Pop-up window will display the current volts/div scale and time base scale when volts/div scale and time base scale changes. And the window only displays for 3s.
- ⑫ CH1 vertical icon: Display activated state, channel coupling, bandwidth limit, vertical scale and probe attenuation factor of CH1.
 - Channel activated stat: **1** **500mV 1.000XB**
 - Bandwidth limit: "B" icon will appear in CH1 vertical state when this function is enabled.

- Vertical scale: Display vertical scale of CH1 when CH1 is activated. This parameter can be changed by using SCALE knob on vertical control area. A volts/div scale will pop up on the screen when the time base scale changes.
 - Probe attenuation factor: Display probe attenuation factor of CH1, which includes 0.001X, 0.01X, 0.1X, 1X, 10X, 100X, 1000X and user-defined.
 - Volts/div scale: A "🔍" icon will appear in CH1 vertical state when volts/div scale setting is fine tuning.
 - Tap vertical state area to pop out channel 1 interface as shown in Figure 4-7(c) Volts/div scale and vertical displacement value can be changed by using numeric keypad, ,  and vertical SCALE knob and vertical Position knob.
 - Tap analog channel digit to enable, activate and disable the channel.
- ⑬ HOME Menu: HOME menu is in the left corner of the screen, which includes cursor, mathematical operation, spectrum analysis, recording waveform, pass/fail test, reference waveform, decoding, bode diagram, drawing rectangle, frequency meter, voltmeter and help shortcut menu.
- Cursor: Tap cursor icon in HOME menu to enter CURSOR menu, it can set cursor measurement directly, refer to Cursor Measurement for more details.
 - Mathematical operation: Tap mathematical operation icon in HOME menu to enable MATH function and set the type to MATH.
 - Spectrum analysis: Tap spectrum analysis icon in HOME menu to enable MATH function and set the type to FFT.
 - Recording waveform: Tap recording waveform icon in HOME menu to enter recording waveform menu and to setup. Refer to Recording Waveform for more details.
 - Pass/fail test: Tap pass/fail test icon in HOME menu to enter pass/fail menu to setup. Refer to Pass/Fail Test for more details.
 - Reference waveform: Tap reference waveform icon in HOME menu to enter REF Load menu to operating recall waveform.
 - Decoding: Tap decoding icon in HOME menu to enter Decode menu to operating decoding. Refer to Protocol Decoding for more details.
 - Bode diagram: Tap bode diagram icon in HOME menu to enter bode diagram menu to setup. Refer to Bode Diagram for more details.
 - Drawing rectangle: Tap drawing rectangle icon in HOME menu to enter drawing rectangle menu to setup. Refer to Drawing Rectangle for more details.
 - Frequency meter: Tap frequency meter icon in HOME menu to turn on/off frequency meter quickly. The frequency meter status of all of the channels is turned on by default. When the frequency meter is turned on, the icon is highlighted.
 - Voltmeter: Tap voltmeter icon in HOME menu to enter voltmeter menu to setup state of voltmeter, source and mode. The voltmeter status of all of the channels is turned on by default.
 - a. Voltmeter state: ON or OFF
 - b. Source: Set the measuring source of multimeter, which can set to CH1, CH2, CH3 or CH4.
 - c. Mode: AC, DC, AC & DC.
 - Help: Tap help icon in HOME menu to enter help menu.
- ⑭ Analog channel icon and waveform: Display channel identification and waveform of CH1 ~ CH4, the color of channel identification will be the same with waveform.

4.7 Touch Screen

MSO/UP03000E series provides 8 inch super capacitive touch screen, multiple point touch control and gesture control. MSO/UP03000E has easily operating system with flexible and high sensitive touch screen features for great waveform display and excellent user experience.

Touch control function includes tap, squeeze, drag and drawing rectangle.

Hint: The menu displayed on the screen of the oscilloscope can all use the touch control function.

(1) Tap

Use one finger to slightly tap icon or word on the screen as shown in Figure 4-8. Tap gesture can use for:

- Tap menu displayed on the screen and then to setup.
- Tap the function guide icon on the left corner of the screen to enable it.
- Tap to pop out numeric keypad to set parameter.
- Tap virtual keyboard to set label and file name.
- Tap message to pop out close button on the right corner to close it.
- Tap other window displayed on the screen to setup.



Figure 4-8 Touch Gesture

(2) Squeeze

Squeeze two fingers together or separate. Squeeze gesture can zoom out or zoom in the waveform. If the waveform need to zoom out, squeeze two finger together and then slide away; If the waveform need to zoom in, separate two fingers and then squeeze two fingers together as shown in Figure 4-9. Squeeze gesture can use for:

- Adjusting horizontal time base of waveform on the horizontal direction.
- Adjusting vertical scale of waveform on the vertical direction.

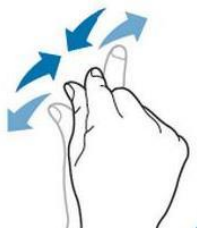

Figure 4-9 Squeeze Gesture

(3) Drag

Use one finger to press and drag the selected item to the aimed position as shown in Figure 4-10. Drag gesture can use for:

- Drag waveform to change waveform displacement or offset.
- Drag window control to change window position (such as numeric keyboard).
- Drag cursor to change cursor position.

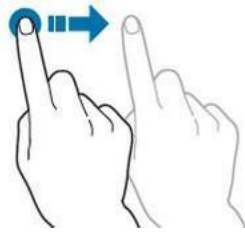

Figure 4-10 Drag Gesture

(4) Drawing Rectangle

Open function guide and tap drawing rectangle icon to switch drawing rectangle mode. Drag finger on the screen to drawing rectangle as shown in Figure 4-11(a), 4-11(b). Move finger away from the screen, menu displayed on the screen, tap to select "Area A enable", "Area B enable", "Intersection", "Non-intersecting", "Source". Drag finger on the screen from bottom right up to top left to drawing the trigger area.





Figure 4-11 Drawing Rectangle Gesture

Select "Area A":

- Drawing the area of trigger area A;
- Open trigger area A;
- Open "trigger area" menu.

Select "Area B":

- Drawing the area of trigger area B;
- Open trigger area B;
- Open "trigger area" menu.

Hints: Press "drawing rectangle" icon to switch drawing rectangle and operating waveform mode. Press "drawing rectangle" icon, if icon displays , which represents the drawing rectangle mode is opened; press "drawing rectangle" icon, if icon displays , which represents the operating waveform mode is opened. Operating waveform mode of the oscilloscope is enabled by default.

(5) Touch shortcut operating

Separate two fingers and meanwhile slide two fingers to one direction, this gesture can quickly turn on/off time measurement and voltage measurement cursor.

a. Time measurement cursor

- Slide down in vertical to directly turn on time measurement cursor as shown in Figure 4-12 (a);
- Slide up in vertical to directly turn off time measurement cursor;

b. Voltage measurement cursor

- Slide right in horizontal to directly turn on voltage measurement cursor as shown in Figure 4-12 (b);
- Slide left in horizontal to directly turn off voltage measurement cursor;

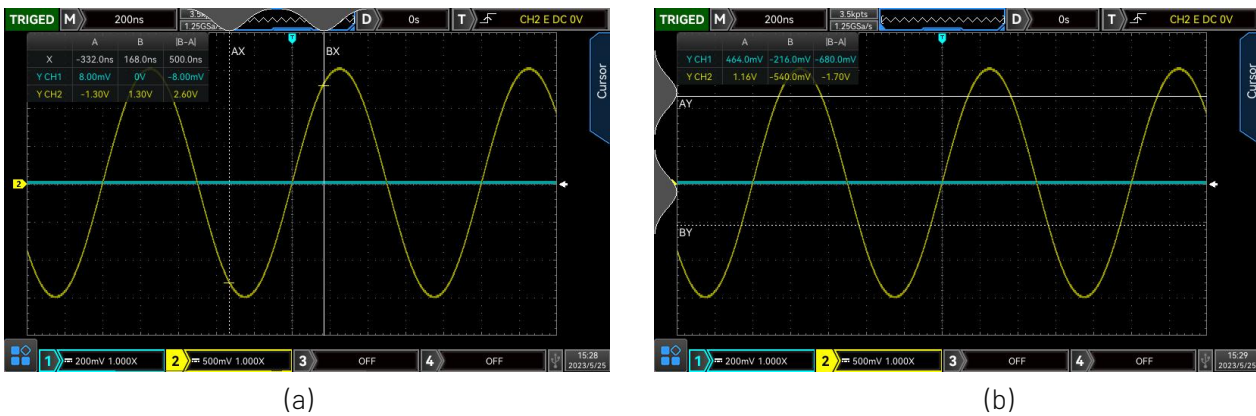

Figure 4-12

Note: Turn on/off cursor requires that slide distance should be $>3\text{div}$.

4.8 Introduction of Special Symbol

Press any soft key to activate the corresponding menu, the following icon may displayed on the menu.



This symbol represents that multipurpose knob on the front panel can be used to select and adjust parameter.



This symbol represents that there are several options.



This symbol represents that there has next menu.



This symbol represents that the menu has two options.



This symbol represents that multipurpose knob and jog dial on the front panel can be used to adjust parameter.



This symbol represents that numeric keypad on the front panel or touch to pop out numeric keyboard to input content.



This symbol represents that the current page can be flipped up or down.



Circle numbers represents that the total pages of menu. Single page has no circle display, two pages or more have circle display. Use  key to turn page.

5. Vertical Channel

MSO/UP03000E provides two models of 4 or 2 analog input channel. 4 analog channels are CH1~CH4. Vertical channel setting method for each channel is quite the same. 2 analog channels are CH1~CH2. In this chapter, take 1 (channel 1) as an example to introduce vertical channel setting.

- Turn on/Activate/Analog Channel
- Channel Coupling
- Bandwidth Limitation
- Volts/div Scale

- Probe
- Impedance
- Reverse Phase
- Unit
- Bias Voltage
- Label

5.1 Turn on/Activate/ Analog Channel

Four analog channel CH1~CH4 includes three states: Turn on, shut down and activate.

- ① Turn on: Press any one of 1 , 2 , 3 , 4 key to turn on the channel when channel is shut down.
- ② Shut down: Waveform will not display in this state. Press the corresponding channel key to turn off which channel has been opened and activated.
- ③ Activate: When multiple channels are enabled, only one channel can be activated (channel should be in open state). Vertical scale, vertical displacement and channel setting can be adjusted in the activate state. Any of the channels that have been opened but not activated could be activated by the corresponding channel keys. The oscilloscope will display channel menu when the channel is activated.

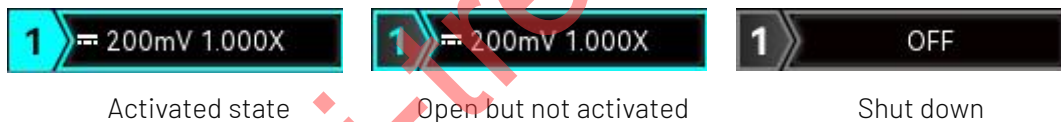

5.2 Channel Coupling

Set channel coupling mode in channel, which can select to DC (direct current), AC (alternating current) and ground.

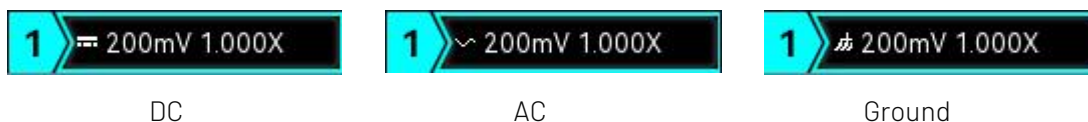

5.3 Bandwidth Limitation

The bandwidth limit can set to 20 MHz and full bandwidth. When soft key menu sets to 20 MHz, the bandwidth of the oscilloscope is limited to about 20 MHz and the high frequency signal above 20 MHz in the attenuation signal. It is often used to observe high frequency noise when low frequency signals is reducing. When the bandwidth limit function is turned on, the B icon will appear in the vertical state, as shown in Figure below.

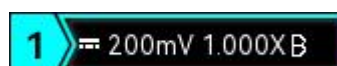

B Icon

5.4 Volts/div Scale

Volts/div scale can be set in channel or press vertical **SCALE** knob to switch it. Volts/div scale can set to "coarse /fine tuning". Volts/div scale range is 1mV/div ~ 10V/div v, stepped in 1-2-5 order. In the coarse tuning, it adjusts the vertical unit by normal order; in fine tuning, it adjusts the vertical scale within the current vertical scale range by stepped 1%.

Note: div indicates the square grid of waveform display area, /div represents each square grid.

5.5 Probe

In order to match up the attenuation coefficient setting of the probe, the coefficient need to set in channel operating menu. If the probe attenuation coefficient is 10:1, then the probe coefficient should set to 10X to ensure the correct voltage reading. When channel unit is V, W, U, the probe value can be 0.001X, 0.01X, 0.1X, 1X, 10X, 100X, 1000X and user-defined; when channel unit is A, it displayed as current probe and the probe value can be 5 mV/A, 10 mV/A, 50 mV/A, 100 mV/A, 200 mV/A and user-defined.

5.6 Impedance

Channel impedance can be set to 1 M Ω or 50 Ω . Under different impedance, the range of volts/div scale will be different. When the impedance is 50 Ω , the range of volts/div scale is 1 mV/div ~ 1 V/div; when the impedance is 1 M Ω , the range of volts/div scale is 1 mV/div ~ 10 V/div. If the impedance sets to 50 Ω , Ω icon will display on the vertical status frame.

5.7 Reverse Phase

Set the reverse phase in channel. When reverse phase is turned on, the voltage value of waveform will be reversed and the reverse icon **1** will display on the screen (as shown in Figure 5-2).

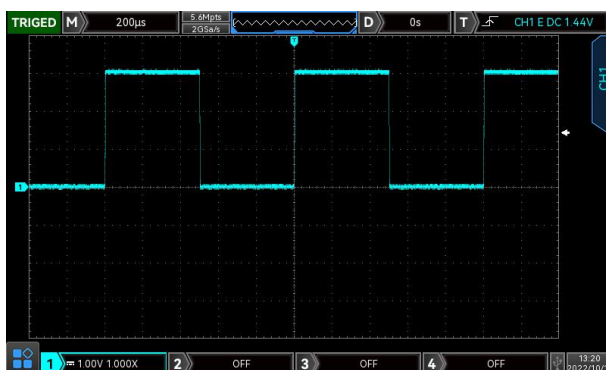

Figure 5-1 Reverse Phase Closed

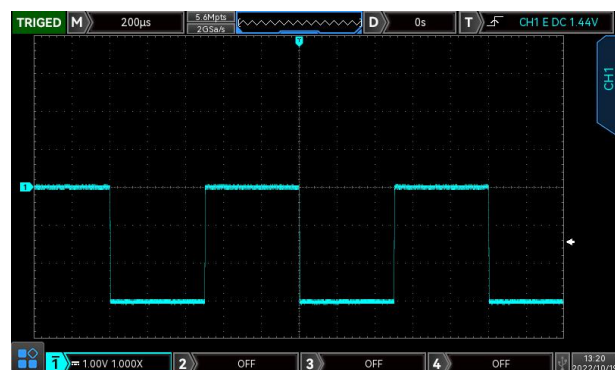

Figure 5-2 Open Reverse Phase

5.8 Unit

Set the amplitude unit for the current channel. Unit setting should set in channel, it can set to "V", "A", "W", "U". The default unit is V. Unit should switch to "A" when using current probe. After the setting, the unit in the channel status label and measurement unit will be change accordingly.

5.9 Bias Voltage

Display bias voltage of the current channel. When waveform moved by vertical Position knob, its voltage value will change accordingly. Change bias voltage value by Multipurpose knob or numeric keyboard, waveform will also move in vertical.

5.10 Label

Set the display label for the current channel. The instrument defaults to use the current channel as the label, such as: CH1. It also supports to set user-defined label.

Label status: ON, the channel's label displays CH1, the label's name can free to select or set by user-defined.

Label status: OFF, the channel's label will not display.

6. Horizontal System

- Horizontal Scale
- ROLL Mode
- Window Extension
- XY
- Multi-Scopes
- Trigger Holdoff

6.1 Horizontal Scale

Horizontal scale which is horizontal time base, the amount of time represented by each scale on the horizontal direction of the screen, usually expressed as s/div. Rotate the SCALE knob in the HORIZONTAL control area to set the horizontal scale according to 1-2-5 order, that is 1 ns/div, 2 ns/div, 4ns/div, 10 ns/div,

20 ns/div... 500 s/div, 1 ks/div. Turn clockwise to decrease the scale, turn counterclockwise to increase the scale. When adjusting the horizontal time base, the scale information will appear in the upper left corner of the screen (as shown in Figure 6-1), it changes in real time.

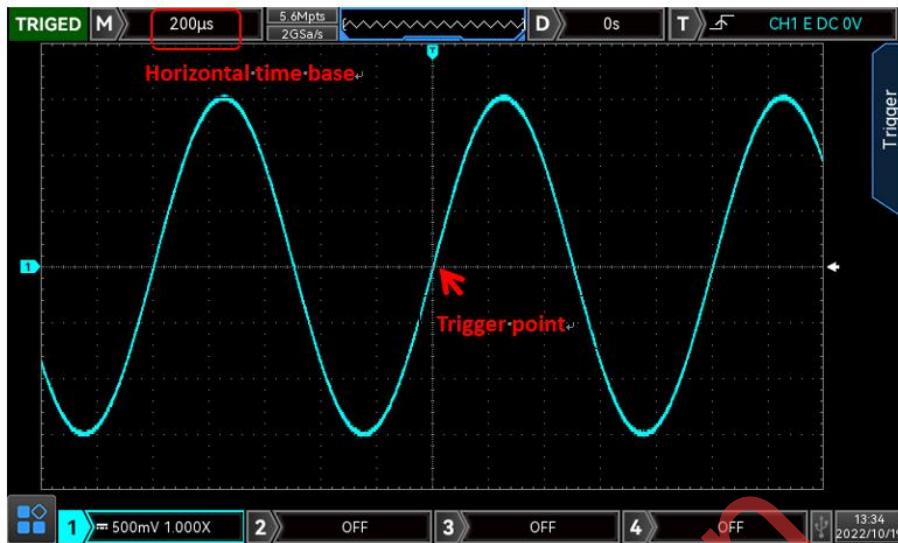

Figure 6-1

When the time base is changing, waveform will be change with trigger point to extended or compressed accordingly.

6.2 ROLL Mode

When trigger mode is in auto state, rotate SCALE knob in the HORIZONTAL control area, the oscilloscope will enter ROLL mode when horizontal scale slow to 20 ms/div.

The oscilloscope will continuously draw a voltage-time trend of the waveform on the screen. In this mode, the waveform is scrolled from right to left to refresh the display, and the latest waveform is drawn at the far right end of the screen. The diagram as shown in Figure 6-2.

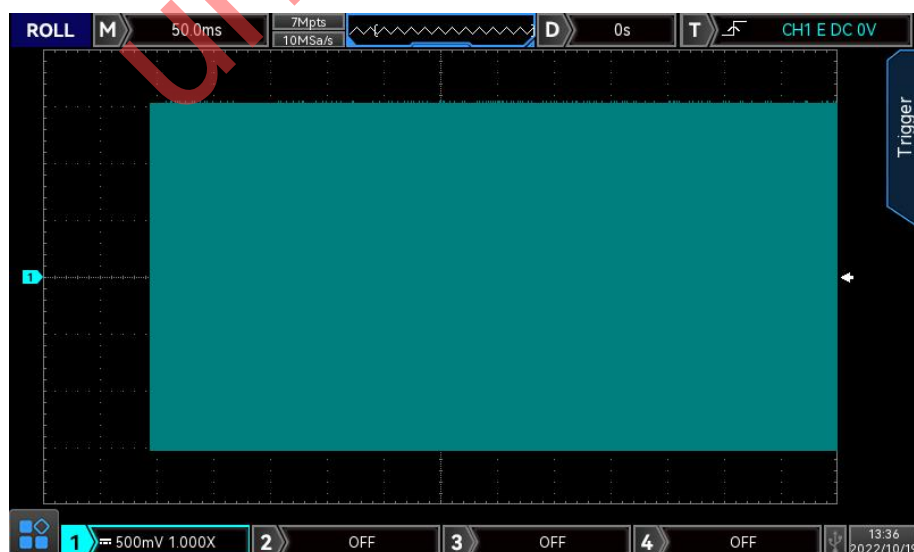

Figure 6-2

Apply to slow sweep mode to observe low-frequency signal, it's recommend that set the channel coupling mode to direct current.

Note: In ROLL mode, "horizontal displacement", "protocol decoding", "pass/fail test", "parameter measurement", "recording waveform" and "waveform brightness" cannot be used.

6.3 Window Extension

Window extension is used for magnifying a waveform to view the image detail. Window extension can be opened in horizontal menu or press HORIZONTAL SCALE knob to open.

In window extension mode, screen will be divided into two display area as shown in Figure 6-3.

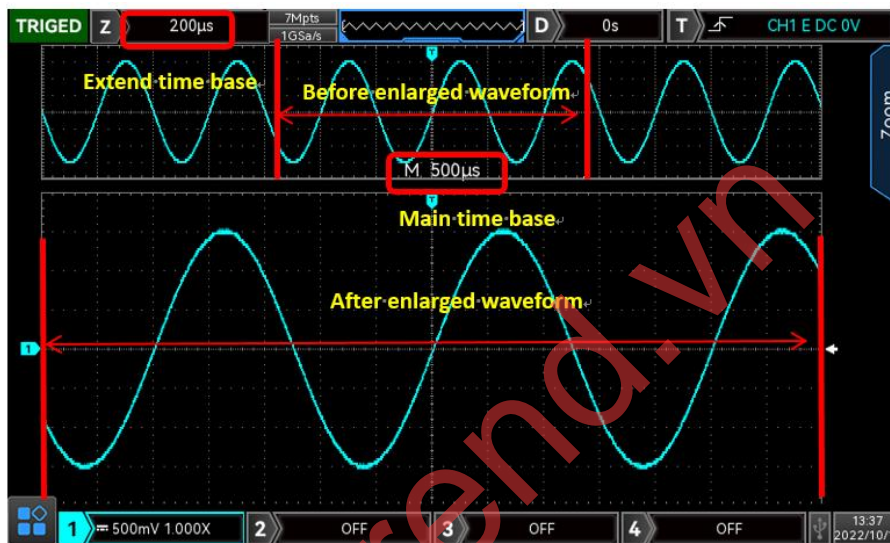

Figure 6-3

The waveform before amplification is shown in the square brackets on the upper part of the screen. It can move by horizontal Position or adjusting time base SCALE to increasing or decreasing this area.

Enlarged Waveform

The enlarged waveform is displayed on the bottom part of the screen, window extension improves resolution relative to the main time base.

Time Base Selection

When window extension is selected, time base menu can set extended time base or main time base.

- Extend Time Base: Rotate horizontal SCALE knob to change time base scale of extend time base.
- Main Time Base: Rotate horizontal SCALE knob to change time base scale of main time base.

Notes: Window extension requires that time base scale should at 20 ms/div ~ 1 ns/div. Only in this range, window extension can be functioned. If turn on extend time base in ROLL mode, the main time base sets to 20 ms by default.

6.4 XY

The waveform displayed in XY mode is also called Lissajous curve. Meanwhile, XY supports cursor

measurement, it can quickly measuring the phase difference between two channels as shown in Figure 6-5.

- (1) Format of Time Base
 - a. YT: Display voltage value on time base (horizontal scale).
 - b. XY: Display Lissajous curve, it can easily measuring phase difference between two signals with same frequency.
- (2) Display
 - a. Full screen: Only display Lissajous curve on the screen.
 - b. Split screen: Display Lissajous curve on the bottom part of the screen, the upper part displays the corresponding waveform of X-Y.

(3) X-Y

Set the waveform that has generated Lissajous curve, which can select CH1-CH2, CH1-CH3, CH1-CH4, CH2-CH3, CH2-CH4, CH3-CH4.

When X-Y menu select CH1-CH2, input CH1 signal on horizontal axis (X axis), input CH2 signal on vertical axis (Y axis).

In XY mode, if CH1 or CH3 is activated, use POSITION knob on VERTICAL control area to move XY curve on horizontal direction; if CH2 or CH4 is activated, use POSITION knob on VERTICAL control area to move XY curve on vertical direction.

In order to get better display effect of Lissajous curve, to adjusting SCALE knob on VERTICAL control area to change each channel's amplitude scale and adjusting SCALE knob on HORIZONTAL control area to change time base scale. Waveform in XY mode as shown in Figure 6-4.

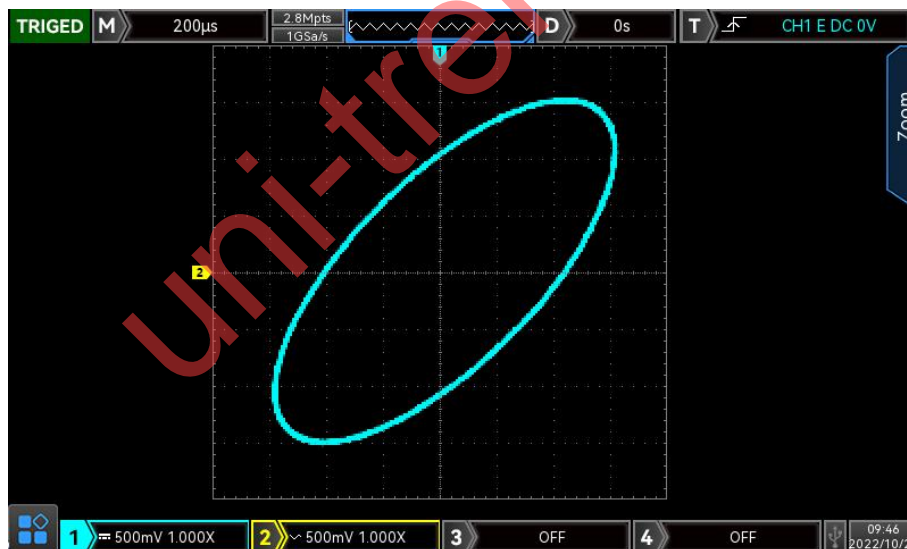

Figure 6-4

Set display menu to split screen in this state and press CURSOR function key, as shown in Figure 6-5.

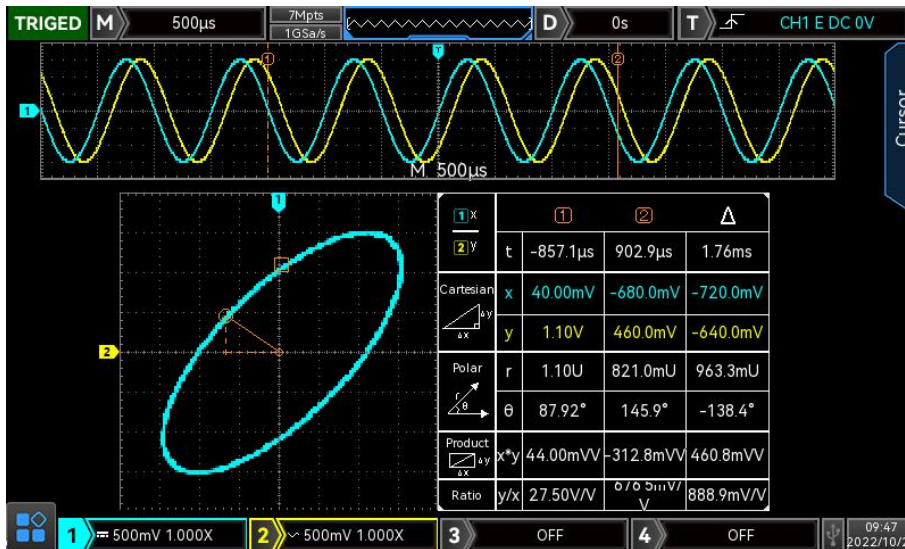

Figure 6-5

Time, rectangular coordinate, polar coordinate, product and proportion in sequence below Cursor①
 Time, rectangular coordinate, polar coordinate, product and proportion in sequence below Cursor②
 Delta (numerical difference between two cursors) in sequence below Δ

Application of XY Mode

Phase difference between in two signals with the same frequency can be easily observed through Lissajous curve. The following figure explains the observation schematic of the phase difference.

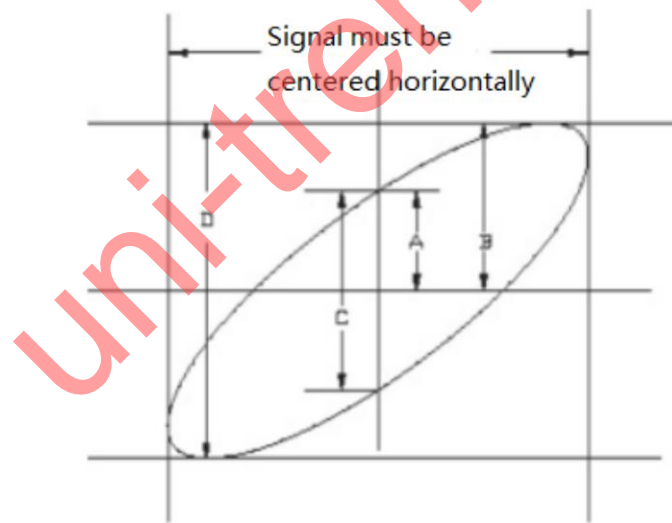

Figure 6-6

Based on $\sin\theta=A/B$ or C/D , θ is the phase angle between channels, the definition of A, B, C, D see Figure 6-6. So the phase angle is $\theta=\pm\arcsin(A/B)$ or $\theta=\pm\arcsin(C/D)$.

If the main spindle of elliptical within I, III quadrant, then the acquired phase angle should at I, IV quadrant, that is within $(0\sim\pi/2)$ or $(3\pi/2\sim2\pi)$.

If the main spindle of elliptical within II, IV, then the acquired phase angle should within $(\pi/2\sim\pi)$ or $(\pi\sim3\pi/2)$.

In addition, if the frequency or phase difference of the two signal to be measured are integer times, calculating the frequency and phase relation of the two signals based on the Figure 6-7.

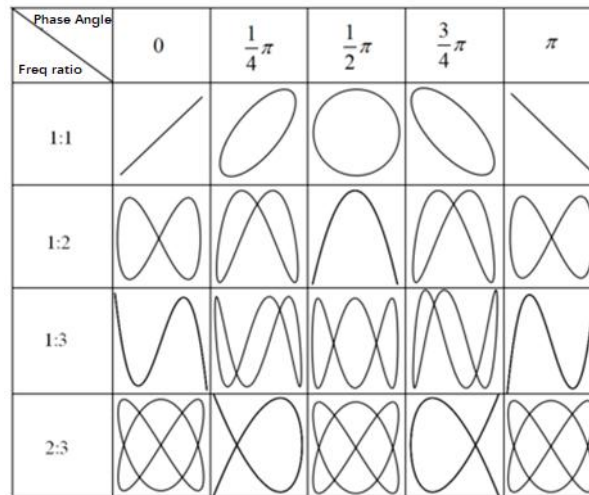

Figure 6-7

6.5 Multi-Scopes

In multi-scopes, CH1~CH4 can be set to different time base scale, so that signals of different frequency in multiple channels can be observed at the same time. Enter Multi-Scopes interface via horizontal menu.

Switch Multi-scopes to enter this mode as shown in Figure 6-8. Each channel can be set to different frequency, amplitude and waveform and all can be stable generated in multi-scopes.

In multi-scopes, it can turn on, shut down, activate the channel. Time base scale, volts/div scale, horizontal displacement, vertical displacement, trigger setting of channel can be adjusted independently.

Multi-Scopes supports split the screen to display the current channel on the upper part for observing waveform, as shown in Figure 6-8.



Figure 6-8

Note: When Multi-Scopes is split to two screens, horizontal of each screen is still 700 pixels, if there are four split screens, horizontal of each screen only has 350 pixels.

6.6 Trigger Holdoff

Trigger holdoff is used for viewing complicated waveform (such as pulse string). Holdoff time refers to the time that the oscilloscope waits to restart the trigger circuit. During hold off, the oscilloscope will not trigger until the end of holdoff time. For example, a group of pulse string, it requires that trigger the first pulse string and the hold off time can be set as width of pulse string, as shown in Figure 6-9.

In **HORI MENU** use multipurpose knob, jog dial and numeric keyboard to set hold off time.

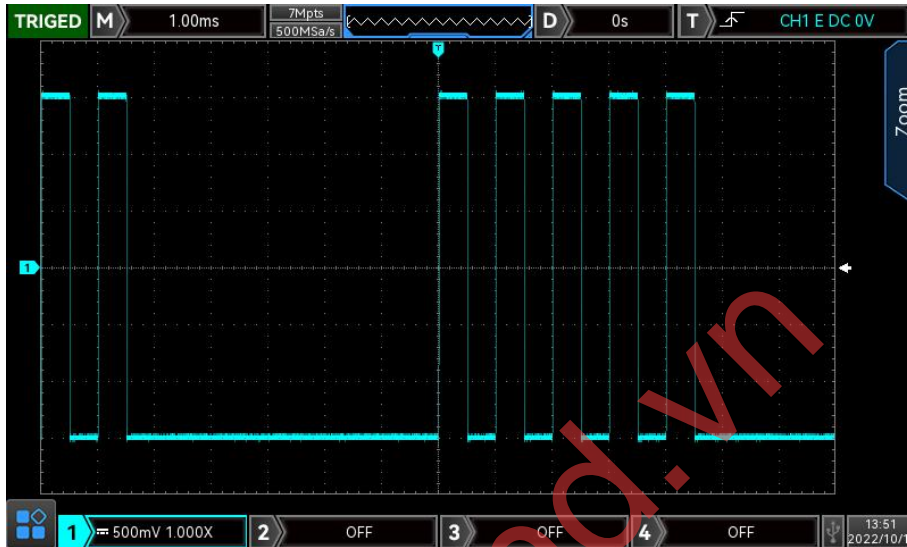

Figure 6-9

7. Trigger System

Trigger determines when the oscilloscope starts to collect data and display waveform. Once the trigger is correctly setup, it can convert unstable signals into meaningful waveform. In the beginning of data acquisition, it collects enough data to compose the waveform at the left side of the trigger point, and continue to collect the data until the trigger condition is met. When a trigger is detected, the oscilloscope continuously collecting enough data to draw the waveform at the right side of the trigger point.

In this chapter, take 4 analog channel (MS03504E-S) as an example to introduce vertical channel setting.

- Noun Explanation of Trigger System
- Edge Trigger
- Pulse Width Trigger
- Video Trigger
- Slope Trigger
- Runt Pulse Trigger
- Over-amplitude Trigger
- Delay Trigger
- Timeout Trigger
- Duration Trigger
- Setup/Hold Trigger
- Nth Edge Trigger
- Pattern Trigger
- RS232 Trigger
- I2C Trigger
- SPI Trigger
- CAN Trigger
- CAN-FD Trigger
- LIN Trigger
- FlexRay Trigger
- Regional Trigger

7.1 Noun Explanation of Trigger System

(1) Trigger Source

A signal for generating a trigger. Trigger can be obtained from a variety of information sources, such as input channel (CH1, CH2, CH3, CH4), digital signal (D0~D15), external trigger (EXT), mains electricity, etc.

- a. Input channel: Select any one of the analog signal input port CH1~CH4 on the front panel of the oscilloscope as a trigger signal.
- b. Digital channel: when digital signal is connected and LA is opened, select any one of digital channel as a trigger signal.
- c. External trigger: Select the input signal EXT Trig (EXT Input) on the rear panel of the oscilloscope as a trigger signal. For example, the external clock input to EXT Trig port to be a trigger source. EXT signal trigger level can be set within the range from -9 V~+9 V.
- d. Mains electricity: Used to observe the related signal of mains electricity, such as the relation of lighting equipment and power supply equipment, to obtain stable synchronization.

(2) Trigger Mode

Trigger mode determines the behavior of the wave during a trigger event. This oscilloscope provides three kinds of trigger modes: auto, normal, and single.

- a. Auto trigger: When there is no trigger signal, the system automatically collect and display data. When the trigger signal is generated, it automatically switch to trigger scanning, so that the signal will be synchronized.

Auto trigger mode is suitable for

- Check DC signal or signal with unknown electrical feature

Note: This mode allows 40 ms/div or in slower time base scale to set no trigger signal in ROLL mode.

- b. Normal trigger: The oscilloscope can only collect data when the trigger condition is satisfied. When there is no trigger signal, the oscilloscope will stop collect data. When the trigger condition is satisfied, refresh the current waveform data display on the screen, otherwise, it remains the last triggered waveform.

Normal trigger mode is suitable for

- Only collect the specific event appointed by the trigger setting;
- Rare trigger event, use normal mode can prevent the oscilloscope from automatic trigger, so that the waveform can be stable display.

- c. Single trigger: In single trigger mode, press **SINGLE** key to delete the waveform display on the screen. The oscilloscope waits for the trigger. When the instrument detects a single trigger, the waveform will be sampled and displayed, and then the instrument enters the STOP state. Press **SINGLE** key on the front panel to delete the waveform display on the screen and quickly enter Single trigger mode.

Single trigger mode is suitable for

- Capture casual event or aperiodicity signal, such as up, down waveform;
- Rare trigger event

(3) Trigger Coupling

Trigger coupling determines which part of the signal will be transmitted to the trigger circuit. The coupling type includes DC, AC, LF reject, HF reject and noise reject.

- a. DC: Let all the components of the signal pass through

- b. AC: Block the DC component of the signal
- c. HF reject: Attenuate high frequency components over 40 kHz.
- d. LF reject: Attenuate low frequency components below 40 kHz.
- e. Noise reject: Suppress high frequency noise in the signal to reduce probability of touch error.

(4) Pre-trigger / Delayed Trigger

Before trigger event / after collect data.

Trigger position is usually set at the horizontal center of the screen, user can observe 7 grids of pre-trigger and delay trigger information. Horizontal move the waveform to view more pre-trigger information. By observing the pre-trigger data, the waveform before generated can be observed. For example, capturing the glitch at the start of the circuit, observing and analyzing the pre-trigger data to find out the cause of the glitch.

(5) Force Trigger

Press **FORCE** key to force to generate a trigger signal. If waveform is not displayed on the screen in normal or single trigger mode, press **FORCE** key to sampling signal baseline and ensure the sampling is performed properly.

7.2 Edge Trigger

The edge can be identify by looking for the specific edge (rising edge, falling edge and random edge) and electrical level. Press edge trigger menu to set source, trigger coupling, trigger mode and edge type.

Waveform can be stable generated when the condition is satisfied, as shown in Figure 7-1.



Figure 7-1

(1) Edge Type:

- a. Rising edge: Set to trigger on the rising edge of the signal.
- b. Falling edge: Set to trigger on the falling edge of the signal.
- c. Random edge: Set to trigger on the rising edge and the falling edge of the signal.

7.3 Pulse Width Trigger

Pulse width trigger can set the oscilloscope at specific width and generated the positive pulse or negative

pulse when meet the trigger condition. Pulse width trigger menu can set source, condition, the upper /lower limit of pulse width, polarity of pulse width (positive and negative), trigger coupling, trigger mode, etc. As shown in Figure 7-2.

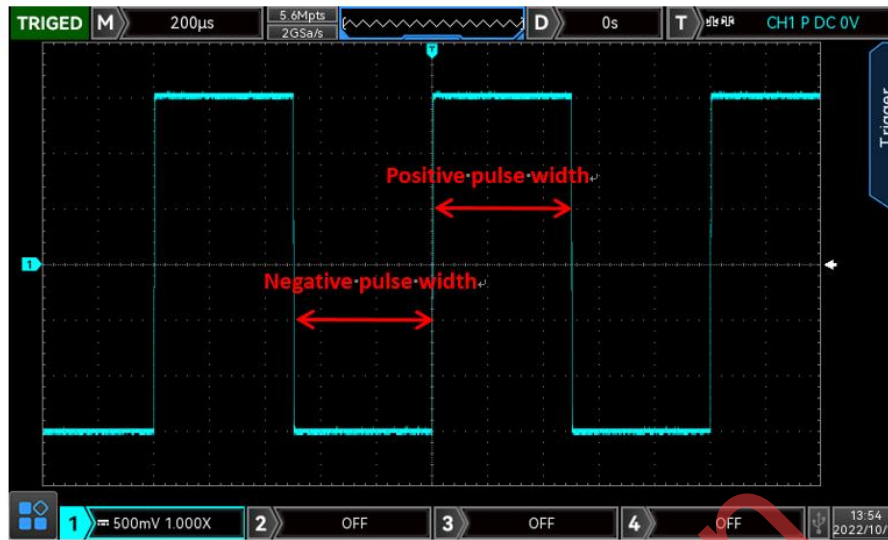

Figure 7-2

(1) Condition

Select trigger condition: ">", "<", "≤".

- a. >: It will be generated when the pulse width of the trigger signal is greater than the pulse width setting, it can set the lower limit of pulse width.
- b. <: It will be generated when the pulse width of the trigger signal is smaller than the pulse width setting, it can set the upper limit of pulse width.
- c. ≤: It will be generated when the pulse width of the trigger signal is basically similar to the pulse width setting or the pulse width of the trigger signal is in the setting scope, it can set the lower/upper limit of pulse width.

(2) The upper /lower limit of pulse width

Compare the setting pulse width value with the signal pulse width. The trigger will be generated when the condition is met. The range can be set to 1ns ~4 s.

7.4 Video Trigger

The video signal includes the image and the time sequence information, it has multiple standards and formats. MSO/UP03000E provides the basic measurement functions, which can be triggered in the filed or line of NTSC (National Television Standards Committee), PAL (Phase Alternating Line) and SECAM (Sequential Couleur A Memoire), as shown in Figure 7-3.

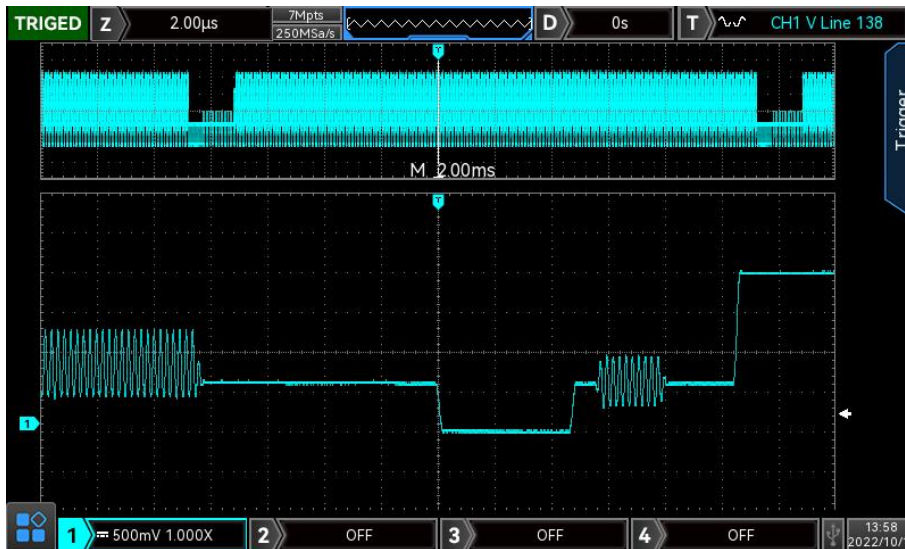

Figure 7-3

(2) Video Format

- a. PAL: The frame frequency is 25 frames per second, the TV scan line is 625 lines, the odd field is in the front and the even field is in the rear.
- b. NTSC: The field frequency is 60 fields per second, and the frame frequency is 30 frames per second. The TV scan line is 525 lines. The even field is in the front and the odd field is in the rear.
- c. SECAM: The frame frequency is 25 frames per second, the TV scan line is 625 lines, interlaced scanning.

(3) Video Synchronization

- d. Even field: Set to trigger and synchronize on the even field of the video signal.
- e. Odd field: Set to trigger and synchronize on the odd field of the video signal.
- f. All lines: Set to trigger and synchronize on the line signal of the video signal.
- g. Specified lines: Set to trigger and synchronize on the specified video lines. User can use the Multipurpose knob to specify the line number, and the setting range is from 1 to 625 (PAL/SECAM), or from 1 to 525 (NTSC).

Hint: In order to observe the waveform details in the video signal, user can set the storage depth a little bigger.

The MSO/UP03000E series utilize the UNI-T original digital 3D technology, it uses a multi-level grayscale display function so that different brightness can reflect the frequency of different parts of the signal. Experienced users can quickly judge the signal quality during the debugging process and find the unusual conditions.

7.5 Slope Trigger

Slope trigger refers to triggering when the slope of signal rising or falling conforms to the setting value. Slope trigger menu can set the source, trigger coupling, trigger mode, edge type (rising edge, falling edge), time condition, the lower limit/ upper limit of time, level setting etc.

(1) Edge Type

- a. Rising edge: Perform slope trigger by using the rising edge of the trigger signal

b. Falling edge: Perform slope trigger by using the falling edge of the trigger signal.

(2) Time Condition

- a. $>$: It will be generated when the slope time of the trigger signal is greater than the setting slope time, it can set the lower limit of time.
- b. $<$: It will be generated when the slope time of the trigger signal is less than the setting slope time, it can set the upper limit of time.
- c. \approx : It will be generated when the slope time of the trigger signal is basically similar to the setting slope time or the pulse width of the trigger signal is in the setting scope, it can set the lower/upper limit of time.

Note: Slope time of trigger signal refers to the figure as shown in below "slope time of rising/ falling edge".

(3) Level Setting

Level setting can set low level, high level and high-low level. Press LEVEL knob on trigger control area to quickly switch the selection.

- a. Low level: Adjust low level threshold of slope trigger by using LEVEL knob on trigger control area.
- b. High level: Adjust high level threshold of slope trigger by using LEVEL knob on trigger control area.
- c. High-low level: Adjust high-low level threshold of slope trigger by using LEVEL knob on trigger control area.

(4) The upper/lower limit of time

Set time value and the range can set to 6.4 ns ~ 1s.

Note: In slope trigger, the setting slew rate value will display on the left corner of the screen. The calculation formula of slew rate value:

$$(\text{High level threshold} - \text{low level threshold}) \div \text{Time}$$

For the setting slew rate value, the time here is the slope time value for the setting slew rate.

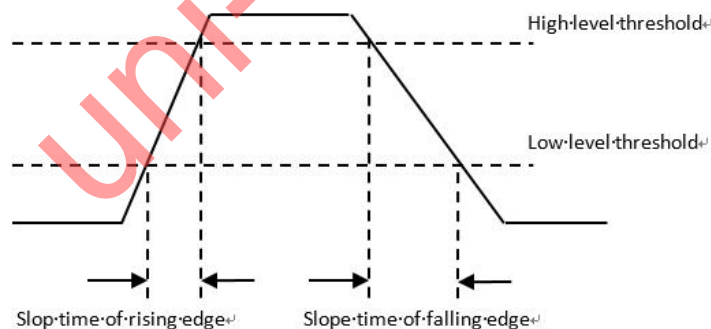

7.6 Runt Trigger

The runt trigger is used to trigger a pulse that has crossed one trigger level but not the other.

In this oscilloscope, the positive runt pulse is the pulse that crosses the lower limit of the trigger level but does not cross the upper limit of the trigger level; the negative runt pulse is the pulse that crosses the upper limit of the trigger level but does not cross the lower limit of the trigger level, as shown in Figure 7-4..

The runt trigger menu can set source, trigger coupling, trigger mode, polarity (positive, negative pulse),

runt condition (irrelevance, $<$, $>$, \leq), the lower/upper limit of time, trigger level setting, etc.

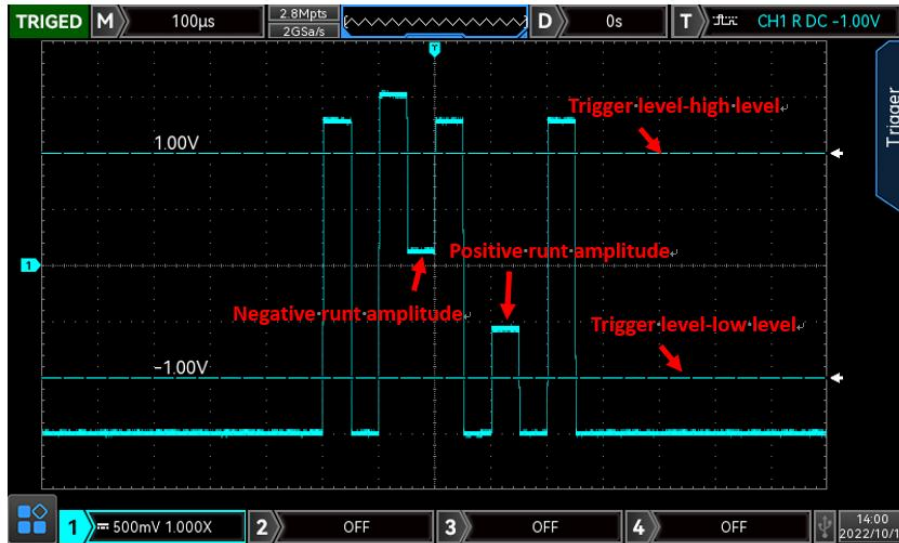

Figure 7-4

- (1) Trigger Polarity
 - a. Positive pulse: Set to trigger on the positive runt pulse.
 - b. Negative pulse: Set to trigger on the negative runt pulse.
- (2) Condition

Trigger condition: Irrelevance, $<$, $>$, \leq .

 - a. Irrelevance: Does not set the runt pulse trigger condition.
 - b. $>$: It will be generated when the runt pulse width is greater than the setting pulse width, it can set the lower limit of time.
 - c. $<$: It will be generated when the runt pulse width is less than the setting pulse width, it can set the upper limit of time.
 - d. \leq : It will be generated when the runt pulse width is in the scope of the setting pulse width or within a range, it can set the lower/upper limit of time.
- (3) The lower/upper limit of time
 - a. Compare the setting pulse width value with pulse width of channel. It will generated when trigger condition is met, range can be set to 6.4 ns ~ 10s.
- (4) Level Setting

Level setting can set low level, high level and high-low level. Press LEVEL knob on trigger control area to quickly switch the selection.

 - a. Low level: Adjust low level threshold of slope trigger by using LEVEL knob on trigger control area.
 - b. High level: Adjust high level threshold of slope trigger by using LEVEL knob on trigger control area.
 - c. High-low level: Adjust high-low level threshold of slope trigger by using LEVEL knob on trigger control area.

7.7 Over-Amplitude Pulse Trigger

Trigger level of over-amplitude has a high level and a low level, when the rising edge of the input signal crosses the high level or the falling edge crosses the low level, the oscilloscope will be triggered, as shown

in Figure 7-5. Over-amplitude pulse trigger menu can set source, coupling mode, trigger mode, over-amplitude type (rising edge, falling edge, random edge), position (enter, exit, time), trigger setting, level setting, etc.

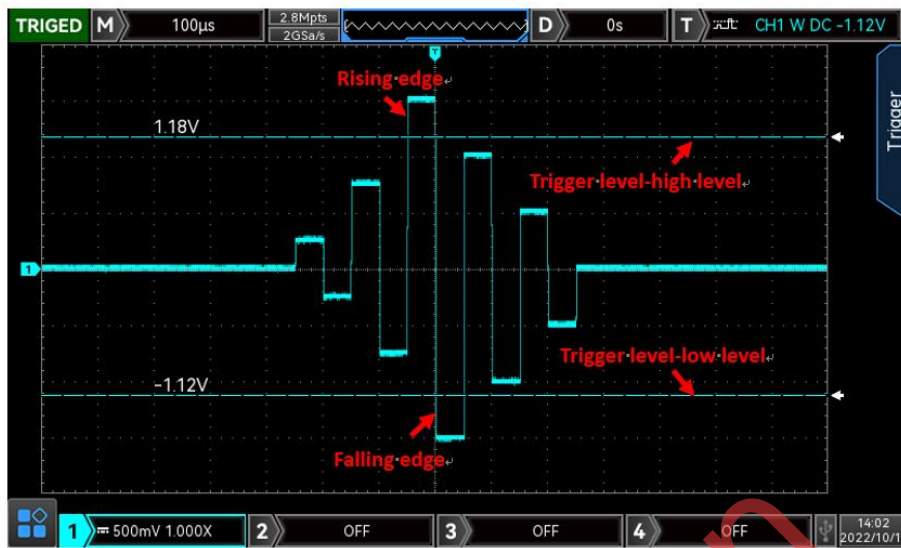

Figure 7-5

(1) Over-amplitude Type

Select which edge that the input signal can be triggered. It can select rising edge, falling edge or random edge. The current slope is displayed in the upper right corner of the screen.

- a. Rising edge: It will be generated when the trigger on the rising edge of the input signal and the voltage level is higher than the setting high level.
- b. Falling edge: It will be generated when the trigger on the falling edge of the input signal and the voltage level is lower than the setting low level.
- c. Random edge: It will be generated when the trigger on the rising/falling edge of the input signal and the voltage level is within the setting level.

(2) Trigger Position

Trigger position can set enter, exit and time. Select trigger position to confirm the timing of trigger.

- a. Enter: It will be generated when the input signal enter the specified trigger level.
- b. Exit: It will be generated when the input signal exit the specified trigger level.
- c. Time: It will be generated when the over-amplitude entered, accumulated hold time is greater than or equal to the preset over-amplitude time.

(3) Trigger Setting

When trigger position is set to "Over-amplitude Time", the setting time takes effect and triggered when condition is met. The range can be set to 6.4 ns ~ 10s.

(4) Level Setting

Level setting can set low level, high level and high-low level. Press LEVEL knob on trigger control area to quickly switch the selection.

- a. Low level: Adjust low level threshold of slope trigger by using LEVEL knob on trigger control area.
- b. High level: Adjust high level threshold of slope trigger by using LEVEL knob on trigger control area.
- c. High-low level: Adjust high-low level threshold of slope trigger by using LEVEL knob on trigger control area.

7.8 Delay Trigger

Delay trigger should set trigger source 1 and trigger source 2. When the time difference (ΔT) between the edge set by source 1 (edge 1) and the edge set by source 2 (edge 2) meets the preset time limit, the oscilloscope is triggered, as shown in Figure 7-6.

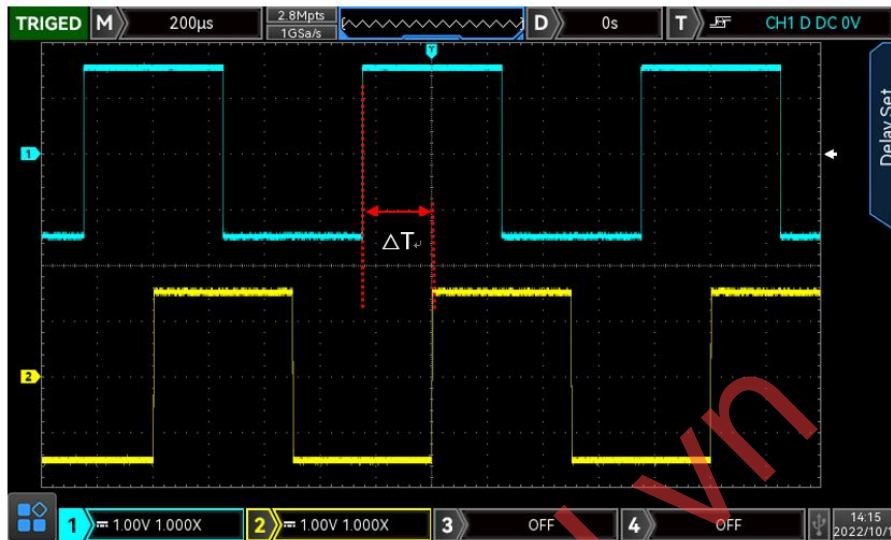

Figure 7-6

Edge 1 set as rising edge, edge 2 also set as rising edge. ΔT is the area marked by red color, as shown in Figure 7-6.

Note: Edge 1 and edge 2 must be adjacent edges.

Note: Only the channel that has been connected to the signal, select it as the trigger source that can get the stable trigger.

(1) Delay Condition

Set delay condition to $<$, $>$, \leq , \geq .

- $>$: It will be generated when the time difference (ΔT) between the edge of source 1 and the edge of source 2 is greater than the setting lower limit of time, it can set the lower limit of time.
- $<$: It will be generated when the time difference (ΔT) between the edge of source 1 and the edge of source 2 is smaller than the setting upper limit of time, it can set the upper limit of time.
- \leq : It will be generated when the time difference (ΔT) between the edge of source 1 and the edge of source 2 is greater than the setting lower limit of time and smaller than the setting upper limit of time, it can set the upper limit and lower limit of time.
- $><$: It will be generated when the time difference (ΔT) between the edge of source 1 and the edge of source 2 is smaller than the setting lower limit of time or greater than the setting upper limit of time. It can set the upper limit and lower limit of time.

(2) The upper/lower limit of time

Compare the setting time value with ΔT , it will be triggered when the condition is met. The range can be set 6.4 ns ~ 10s.

7.9 Time-out Trigger

Timeout trigger can generate the signal when the time interval (ΔT) from the rising edge (or falling edge) of the input signal to adjacent falling edge (rising edge) across the trigger level is greater than the set timeout time. As shown in Figure 7-7.

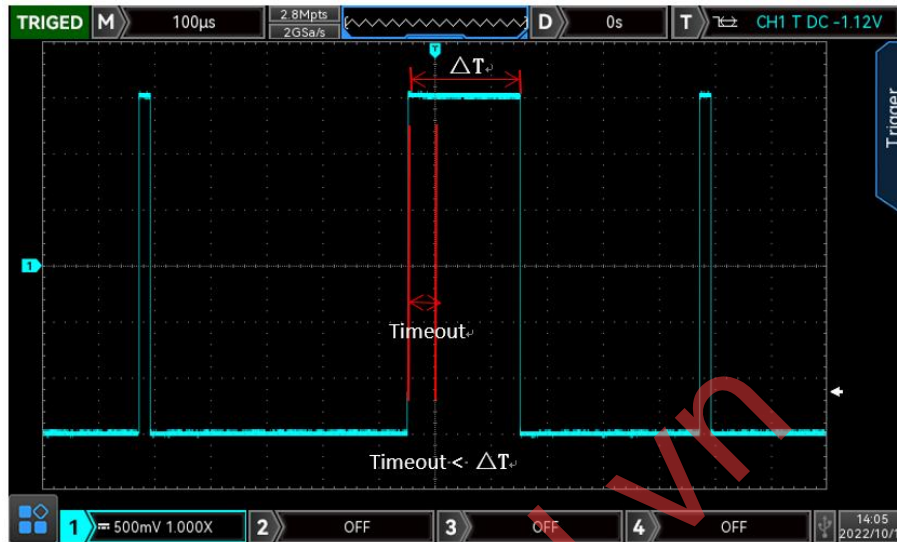

Figure 7-7

(1) Edge Type

Select which edge that the input signal can be triggered. It can select rising edge, falling edge, random edge. The current slope is displayed in the upper right corner of the screen.

- a. Rising edge: Set the timer to start when the rising edge of the input signal through the trigger level.
- b. Falling edge: Set the timer to start when the falling edge of the input signal through the trigger level.
- c. Random edge: Set the timer to start when the rising edge or the falling edge of the input signal through the trigger level.

(2) Timeout

Compare timeout with ΔT , it will be triggered when the condition is met. The range can be set 6.4 ns ~ 10s.

7.10 Duration Trigger

With duration trigger selected, the oscilloscope identifies the trigger condition by looking for the duration of the specified codes. The codes are the combination of channel logic "AND", and the value of each channel can be H (high), L (low), or X (ignored). It will be generated when the duration (ΔT) of the code meets a preset time, as shown in Figure 7-8.

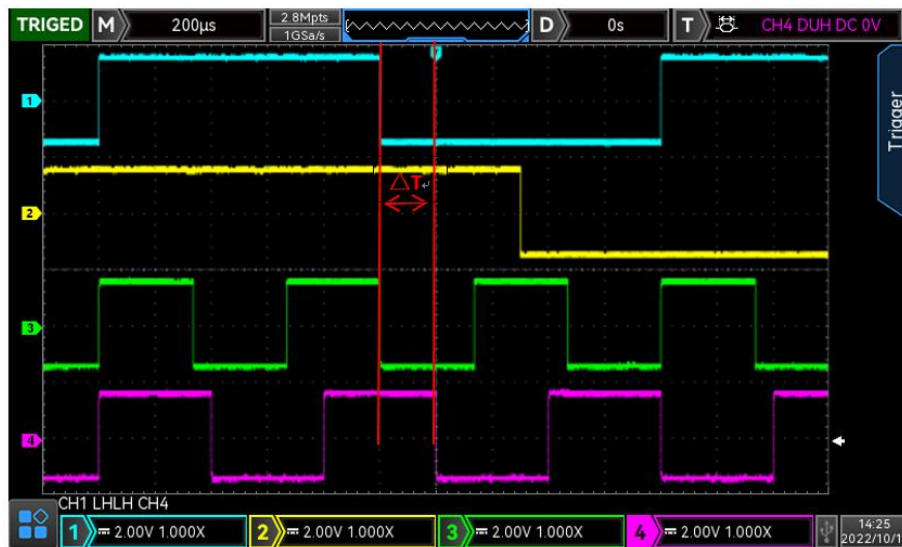

Figure 7-8

(1) Pattern

It has three modes H, L and X. The pattern setting of each channel is displayed at the bottom of the screen, as shown in Figure 7-8.

- H: Set the code value of the selected channel to "High", that is, the voltage level is higher than the trigger level of the channel.
- L: Set the code value of the selected channel to "Low", that is, the voltage level is lower than the trigger level of the channel.
- X: Set the code value of the selected channel to "Ignored", that is, the channel is not part of the pattern. The oscilloscope will not trigger if all of the channels in the codes is set to "ignored".

(2) Trigger condition

- >: It will be generated when the pattern duration is greater than the setting time, it can set the lower limit of time.
- <: It will be generated when the pattern duration is less than the setting time, it can set the upper limit of time.
- ≥: It will be generated when the pattern duration is less than the setting upper time limit and greater and equal than the setting lower time limit, it can set the upper limit and the lower limit of time.

(3) The upper/lower limit of time

Compare the duration time with the setting time of ΔT , it will be triggered when the condition is met. The range can be set to 6.4 ns ~ 10s.

7.11 Setup/Hold Trigger

In setup/hold trigger, the oscilloscope need to set up the data signal line and clock signal line. The setup time begins when the data signal crosses the trigger level and ends when the specified clock edge arrives. The hold time begins when the specified clock edge arrives and ends when the data signal crosses the trigger level again (as shown in Figure 7-9). The oscilloscope will trigger when the setup time or the hold time is less than the preset time. It is mainly used to locate and find error code, and quickly find the signal

that cannot meet setup hold time.

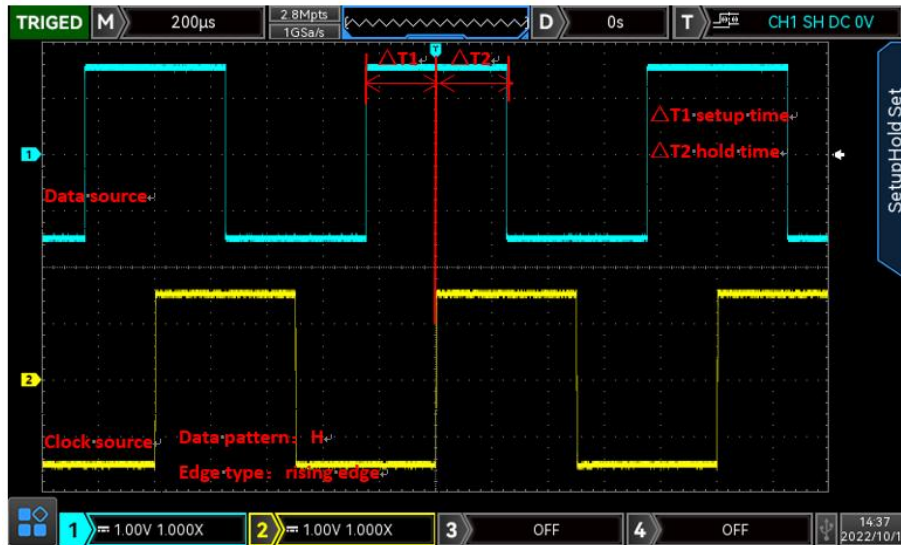

Figure 7-9

(1) Pattern setting

It has two modes H and L.

- a. H: Set the valid pattern of the data signal to high level.
- b. L: Set the valid pattern of the data signal to low level.

(2) Edge type

Select the clock edge type: rising edge and falling edge.

- a. Rising edge: Set the clock edge type to rising edge.
- b. Falling edge: Set the clock edge type to falling edge.

(3) Setup/Hold

It has three modes setup, hold, setup & hold.

- a. Setup: It will be generated when the setup time is less than the setting value.
- b. Hold: It will be generated when the hold time is less than the setting value.
- c. Setup & hold: It will be generated when the setup time and the hold time are all less than the setting value.

(4) Time

Compare the setup, hold time of pattern with the setting time of ΔT , it will be triggered when the condition is met. The range can be set 3.2 ns ~ 1s.

7.12 Nth Edge Trigger

The Nth edge trigger is triggered on the Nth edge after the specified idle time. For example, waveform as shown in Figure 7-10, it is set to trigger on the 2nd rising edge after the specified idle time (the time between two adjacent rising edge), then set the idle time as $P < \text{idle time} < M$, M is the time between the 1st rising edge and the next rising edge, P is the maximum time between the counting rising edge.

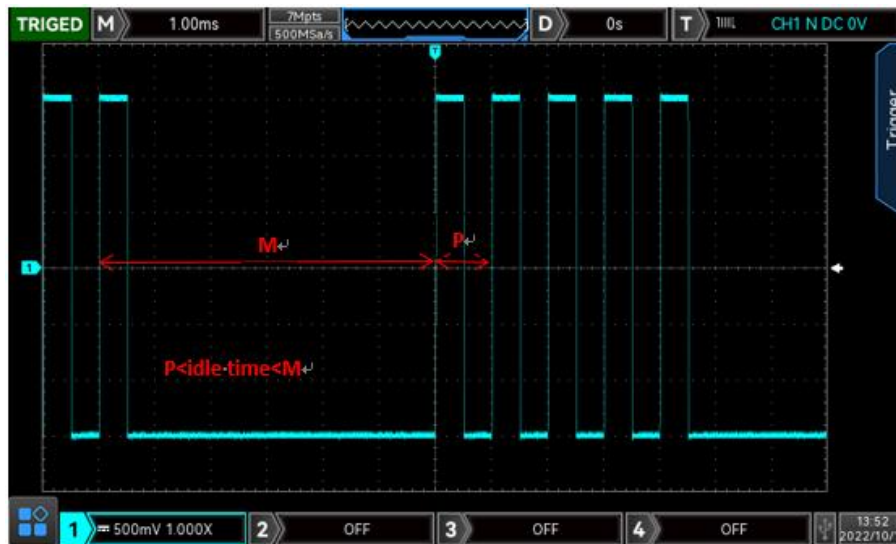

Figure 7-10

(1) Edge type

Select which edge that the input signal can be triggered. It can select rising edge, falling edge. The current slope is displayed in the upper right corner of the screen.

- a. Rising edge: Set to trigger on the rising edge of the signal.
- b. Falling edge: Set to trigger on the falling edge of the signal.

(2) Idle Time

Compare the idle time with pulse time, it will be triggered when the condition is met. The range can be set 6.4 ns ~ 10s.

(3) Edge Count

The number of edge means that the pulse string is triggered at which edge. The edge value can be set by using multipurpose knob, jog dial and numeric keypad. The edge value range can be set 1 to 65535.

7.13 Pattern Trigger

The pattern trigger identifies the trigger condition by looking for the specified patterns. The pattern trigger type is the combination of the channel logic "AND", each channel can be set to H (high), L (low), X (ignored). You can also specify a channel in the type as a rising edge or falling edge (only one edge can be specified). When the edge is assigned, if the pattern of the other channels are judged "true" (i.e., the actual pattern is consistent with the preset pattern type), the oscilloscope will trigger on the specified edge. If the edge is not assigned, the oscilloscope will trigger at the last edge of the code type "true". If the pattern of all of the channels is set to "ignore", the oscilloscope will not be triggered.

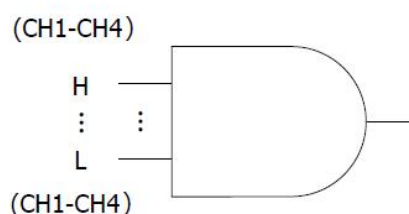

(1) Pattern

There are H, L, X, rising edge, or falling edge. The pattern setting of each channel is displayed at the bottom of the screen.

- a. H: Set the pattern value of the selected channel to "High", that is, the voltage level is higher than the trigger level of the channel.
- b. L: Set the pattern value of the selected channel to "Low", that is, the voltage level is lower than the trigger level of the channel.
- c. X: Set the pattern value of the selected channel to "Ignored", that is, the channel is not part of the pattern. The oscilloscope will not be triggered if all of the channels in the pattern is set to "ignored".
- d. Rising edge: Set the pattern to the rising edge of the selected channel.
- e. Falling edge: Set the pattern to the falling edge of the selected channel.

7.14 RS232 Trigger

RS232 decoding trigger can set trigger condition, data, trigger coupling, trigger mode and decoding setting.

(1) Trigger Condition

- a. Start frame: Waveform triggering at the start bit of RS232 protocol. When send a single string or send the same string several times, this trigger can be used to see a stable signal waveform, and if the sent data changes, the corresponding waveform will also be change.
- b. Error frame: When receiving 0 in the stop state or data error occurs in the middle of data bits.
- c. Parity error: RS232 protocol sets the parity bit to 0 or 1 according to the parity rule when there is a parity bit setting.

The parity rule is as follows.

Odd parity: If in data bits and parity bits, number of bit 1 is odd, then the transmission is correct.

Even Check: If in data bits and parity bits, number of bit 1 is even, then the transmission is correct.

Using this option, user can check the RS232 communication process and quickly find the transmission process of parity error, so that you can easily locate the fault analysis.

- d. Data: The trigger is generated when the data acquired by the oscilloscope is the same as the 2 bits hexadecimal number set by the user. Using this option, user can quickly find the transmission signal of the specific data that interested.

(2) Data

It will be valid when the trigger condition is "Data", the range can set to 00 ~ FF (hexadecimal number).

(3) Decoding Setting

Quickly enter the entrance of RS232 protocol decoding, refer to reference protocol decoding "[RS232 Decoding](#)".

7.15 I²C Trigger

I²C decoding trigger can set trigger coupling, trigger mode, operating direction, decoding setting and trigger condition.

(1) Operating Direction

It can set "write or read".

- a. Write: It will be generated when the "read/write" bit of the I²C protocol is "write".
- b. Read: It will be generated when the "read/write" bit of the I²C protocol is "read".

(2) Trigger Condition

It can set the I²C trigger condition to start, restart, stop, loss confirmed, address, data and address data.

- a. Start: It will be generated at the start time, that is, when the SCL is in high level, the SDA signal has a falling edge.
- b. Restart: It will be generated at the restarting time, that is, after a start signal, and before it stops, the start signal appears again.
- c. Stop: It will be generated when the stop bit occurs, that is, when the SCL is in high level, the SDA signal jumps from low to high.
- d. Loss Confirmed: In I²C protocol, every time after 8 bits of information are transmitted, the data receiver needs to send an acknowledgement signal, which is the ACK bit in the above figure when the SCL is in high level, the SDA signal is low. The loss trigger will occur while the SCL and SDA signal at the ACK bit are both high.
- e. Address: It will be generated when the communication address is the same with the user setting address. It can help to quickly locate the address transmission.
- f. Data: It will be generated when the detected data is equal to/ greater than/ less than/ not equal to the setting value. This feature is convenient for the data analysis and can capture the abnormal data.
- g. Address & Data: It will be generated when the addresses are the same and the data relationship meets the setting conditions during the transmission process. This trigger condition makes it easy to implement the I²C specified address and data trigger, and help to analyze the transmission.

(3) Address Bit Width

When the trigger condition is select "address" or "address data", the address bit width of I²C signal can set to 7 bits or 10 bits.

(4) Address

It will be valid when the trigger condition is "address" or "address data", the range can set to 00 ~ FFF(hexadecimal number).

(5) Byte Length

It will be valid when the trigger condition is "address" or "address data", it can set the specific byte length, the range can be 1~5.

(6) Data

It will be valid when the trigger condition is "address" or "address data", the range can set to 00~FFFFFFFF(hexadecimal number). Press Multipurpose knob to set the data.

(7) Decoding Setting

Quickly enter the entrance of I²C protocol decoding, refer to reference protocol decoding "I²C Decoding".

7.16 SPI Trigger

SPI decoding trigger can set trigger condition, data, idle time, trigger coupling, trigger mode and decoding setting.

(1) Trigger Condition

- a. Enable chip selection includes chip selection and chip selection & data. It will generated on the edge that chip selection level change invalid jump to valid.
- b. Idle time includes idle and idle & data. Idle trigger is generated at start of the new data after a certain idle time.

(2) Data

When trigger condition selects "chip selection & data" and "idle & data", it can set the data parameter, such as bit width, frame length, MOSI data.

Note: The maximum data length of a frame is 128 bits.

a. Bit Width

Set the bit width of each data unit signal in SPI protocol signal, the range can set to 4~32 bits.

b. Frame Length

Set the length of data unit, the range can set to 1~32.

c. MOSI Data

Set MOSI data which is relate to frame length and the range can set to 0 ~ FFFFFFFFFFFFFFFFFFFFFFFFFFFFFFFFFF.

(3) Idle Time

The idle time counter counts when the SCK is unchanged, and judges whether the count value exceeds the preset value at the SCK valid edge, if it exceeds, it will be generated at the valid edge. The counter will be cleared when each clock edge is valid. The range can set to 100 ns ~ 1s.

(4) Decoding Setting

Quickly enter the entrance of SPI protocol decoding, refer to reference protocol decoding "[SPI Decoding](#)".

7.17 CAN Trigger

CAN decoding trigger can set trigger condition, trigger coupling, trigger mode and trigger setting.

(1) Trigger Condition

The CAN trigger condition can set start frame, data frame, remote frame, error frame, overload frame, identifier, data, ID and data, end of frame, loss confirmed and bit stuff error.

- a. Start Frame: The oscilloscope will generate waveform on start frame.
- b. Data Frame: The oscilloscope will be generate on data frame match with CAN signal.
- c. Remote Frame: It will be generated on remote frame.
- d. Error Frame: The oscilloscope will be generated on error frame of CAN signal.
- e. Overload Frame: The oscilloscope will be generated on overload frame of CAN signal.
- f. Identifier: The oscilloscope will be generated on data frame that matches the specified ID.
- g. Data: The oscilloscope will be generated on data frame that matches the specified ID. // (data frame and remote frame have ID, data frame has data, remote frame has no data.)
- h. ID and Data: The oscilloscope will be generated on data frame that matches the specified ID.

- i. End of Frame: It will be generated on the end of frame of CAN signal.
 - j. Loss Confirmed: It will be generated on loss confirmed of CAN signal.
 - k. Bit stuff error : In the segment that requires bit filling, the waveform will be triggered when continuous detect the error from the same level of 6 bits.
- (2) Frame Format
It is valid when the trigger condition is "identifier" or "ID & data", it can set to "standard format, extend format". Different frame format has different ID range value.
- (3) ID Value
It is valid when the trigger condition is "identifier" or "ID & data". It can set ID value, the range is 000~7FF, 00000000~1FFFFFFF.
- (4) Operating Direction
It is valid when the trigger condition is "identifier". And can set "read, write, read or write".
- a. Write: It will be generated when the "read/write" bit of the CAN protocol is "write".
 - b. Read: It will be generated when the "read/write" bit of the CAN protocol is "read".
 - c. Read or write: It will be generated when the "read/write" bit of the CAN protocol is "write or read".
- (5) Byte Length
It is valid when the trigger condition is "data" or "ID & data". Set the length byte of data to be triggered and the range is 1~8.
- (6) Data
Set the data to be triggered. It is valid when the trigger condition is "data" or "ID and data", the length byte of data is related to byte value and the range is 00~FFFFFFFFFFFFFFFF.
- (7) Decoding Setting
Quickly enter the entrance of CAN protocol decoding, refer to reference protocol decoding "[CAN Decoding](#)".

7.18 CAN-FD Trigger

CAN-FD decoding trigger can set trigger condition, trigger coupling, trigger mode and trigger setting.

- (1) Trigger Condition
The CAN-FD trigger condition can set start frame, data frame, remote frame, error frame, overload frame, identifier, data, ID and data, end of frame, loss confirmed and bit stuff error.
- a. Start Frame: The oscilloscope will generate waveform on start frame of CAN-FD protocol.
 - b. Data Frame: The oscilloscope will be generate on data frame match with CAN-FD signal.
 - c. Remote Frame: It will be generated on remote frame.
 - d. Error Frame: The oscilloscope will be generated on error frame of CAN-FD signal.
 - e. Overload Frame: The oscilloscope will be generated on overload frame CAN-FD signal.
 - f. Identifier: The oscilloscope will be generated on data frame that matches the specified ID.
 - g. Data: It will be generated when CAN-FD protocol sampling data is consist with user-defined data. It can help user can quickly find the transmission signal of the specific data that interested.
 - h. ID and Data: The oscilloscope will be generated on data frame that matches the specified ID.
 - i. End of Frame: It will be generated on the end of frame of CAN-FD signal.
 - j. Loss Confirmed: It will be generated on loss confirmed of CAN-FD signal.
 - k. Bit stuff error : In the segment that requires bit filling, the waveform will be triggered when continuous detect the error from the same level of 6 bits.
- (2) Frame Format

It is valid when trigger condition is "identifier" or "ID & data". It can set "standard format, extend format, FD standard format and FD extend format". Different frame format has different ID range value. "Stand format, extend format" is suitable for CAN signal; "FD standard format, FD extend format" is suitable for CAN-FD signal.

(3) ID Value

It is valid when trigger condition is "identifier" or "ID & data". It can set ID value, the range is 000~7FF, 00000000~1FFFFFFF.

(4) Data

a. Byte Length: set the byte length of data to be triggered. Different byte length has different data range. The byte length rang is 1~16.

b. Data: Set data to be triggered, the range can set to 00 ~ FFFFFFFFFFFFFFFFFFFFFFFFFFFFFFFF.

c. Bias: Set the data bias of byte data for delay trigger, it can set on or off. when it is on, display the "byte bias" menu and the bias range is 0~63; when it is off, hide the "byte bias" menu.

(5) Decoding Setting

Quickly enter the entrance of CAN-FD protocol decoding, refer to reference protocol decoding "CAN-FD Decoding".

7.19 LIN Trigger

LIN decoding trigger can set trigger condition, trigger coupling, trigger mode and decoding setting.

(1) Trigger Condition

LIN trigger condition can set synchronization, identifier, data, ID and data, wake-up frame, sleep frame and error frame.

a. Synchronization: The oscilloscope will be generated when detect the synchronizing signal.

b. Identifier: The oscilloscope will be generated when detect ID is equal to the setting frame.

c. Data: Waveform will be generated when the sampled data by LIN protocol is in accord with user-defined data. It can help user quickly find the transmission signal of the specific data that interested.

d. ID and Data: The oscilloscope will be generated when detect ID is equal to the setting frame.

e. Wake-up Frame: The oscilloscope will be generated on wake-up frame of signal.

f. Sleep Frame: The oscilloscope will be generated on sleep frame of signal.

g. Error Frame: The oscilloscope will be generated on error frame of LIN signal, which includes synchronizing error, ID parity error and checksum error.

(2) ID

It is valid when trigger condition is "identifier" or "ID or data". ID value can be set.

When ID parity check is set to "yes", ID range can set to 00~FF.

When ID parity check is set to "no", ID range can set to 00~3F.

(3) Byte Length

It is valid when trigger condition is "data" or "ID or data". Set the byte length of data to be triggered. Different byte length has different data range. Byte length range can set to 1~8.

(4) Data

Set the data to be triggered. It is valid when trigger condition is "data" or "ID & data" and the range is 00~FFFFFFFFFFFFFFFF.

(5) Error Type

It is valid when trigger condition is "error", it can set synchronization, ID parity check and checksum.

- a. Synchronization: synchronizing error
 - b. ID parity check: ID parity check error
 - c. Checksum: data check and error
- (6) Decoding Setting
- Quickly enter the entrance of LIN protocol decoding, refer to reference protocol decoding "[LIN Decoding](#)".

7.20 FlexRay Trigger

FlexRay decoding trigger can set trigger condition, trigger coupling, trigger mode and decoding setting.

- (1) Trigger Condition
- Set FlexRay trigger condition which includes start frame, indicating bit, identifier, cycle count, header field, data, ID & data, end of frame and error.
- a. Start frame: The oscilloscope generates at the start frame of the transmission.
 - b. Indicating bit: The waveform generates when the sampled information is in accord with the setting indicating bit.
 - c. Identifier: The waveform generates when the sampled data is in accord with the setting identifier.
 - d. Cycle number: The waveform generates when the sampled cycle number is in accord with the setting cycle number.
 - e. Header field: The waveform generates when the header field is in accord with the setting header field.
 - f. Data: The waveform generates when FlexRay protocol samples the data is in accord with the user-defined data. It can help user quickly find the transmission signal of the specific data that interested.
 - g. ID and data: The oscilloscope generates when it detects its ID and data is equal to the frame of the setting value.
 - h. End of Frame: The oscilloscope generates at the end of frame.
 - i. Error: The oscilloscope generates at bus error, which includes header CRC error, end of frame CRC error, empty frame static error, empty frame dynamic error, synchronizing frame error and start frame error.
- (2) Indicating bit
- Set the indicating bit of FlexRay protocol trigger, which can be (01XX), net load (11XX), empty (00XX), synchronization (XX10), start (XX11).
- (3) ID
- It is valid when the trigger condition is "identifier" or "ID and data". ID value can set to 000~7FF.
- (4) Cycle number
- It is valid when the trigger condition is "cycle number" or "header field". Cycle number can set to 00~3F.
- (5) Net load length
- It is valid when the trigger condition is "header field". Net load length can set to 00~7F.
- (6) Header CRC
- It is valid when the trigger condition is "header field". Header CRC can set to 000~7FF.
- (7) Data
- a. Byte length: Set the data byte length which need to be trigger. Different byte length "data" has different range. Byte length can set to 1~16.

- b. Data: Set the user-defined data which need to be trigger. The range can set to 00 ~ FFFFFFFFFFFFFFFFFFFFFFFFFFFFFFFF.
- c. Biased data: Set biased data of byte data for trigger, which can set ON or OFF. ON: display "biased data" menu, the biased range is 0~253;
OFF: "biased data" menu will be hidden.

(8) Frame Type

It is valid when the trigger condition is "end of frame". The frame can be static, dynamic or all frame.

- a. Static frame: It will generated in static frame.
- b. Dynamic frame(DTS): It will generated in dynamic frame.
- c. All frame: It will generated in static frame and dynamic frame.

(9) Error Type

It is valid when the trigger condition is "error". The error type includes header CRC error, end of frame CRC error, empty frame static error, empty frame dynamic error, synchronizing frame error and start frame error.

- a. Header CRC: bus header CRC error.
- b. End of frame CRC: bus end of frame CRC error.
- c. Empty frame static error: bus empty frame static error.
- d. Empty frame dynamic error: bus empty dynamic error.
- e. Synchronizing frame error: FlexRay frame has a dedicated indicating bit in the frame header. When this indicating bit is valid, the data frame is a synchronous frame.
- f. Start frame: FlexRay frame has a dedicated indicating bit in the frame header. When this indicating bit is valid, the data frame is a start frame.

(10) Decoding Setting

Quickly enter the entrance of FlexRay protocol decoding, refer to reference protocol decoding "[FlexRay Decoding](#)".

7.21 Regional Trigger

For complicated and volatile circuit signal in circuit debugging, the oscilloscope with high waveform capture rate can easily observe fleeting accidental abnormal signal. If user want to separate the abnormal signal from complicated and volatile circuit and to stable triggered. It may take a lot of time to learn the using of some advanced trigger and even so some more powerful advanced trigger also cannot full triggered.

MSO/UP03000E series add the screen touch regional trigger function, it's really helpful for user to get the using of advanced trigger. Regional trigger function is very easy to use. User just need to open rectangle drawing function to draw one or two rectangle areas in the corresponding signal, it can quickly separate it and for observing signal. Regional trigger can combine with basic trigger, advanced trigger and protocol trigger function and it also supports decoding, recording waveform and pass/fail test. It's really convenient for debugging complicated signal.

Regional trigger provides tow rectangle areas: Region A and Region B. Both regions support setting the region trigger condition to intersection or non-intersection; and the two regions support setting the corresponding enable sources CH1, CH2, CH3, CH4.

(1) Rectangle drawing menu can set region A enable, source A, region B enable, source B.

- a. Region A enable: Set whether Region A is effective, it can be ON or OFF.
If there is a region frame is display on the screen, ON: display region frame; OFF: turn off region frame.
 - b. Source A: Set source of region A enable, which can be CH1~CH4.
 - c. Region B enable: Set whether Region B is effective, it can be ON or OFF.
If there is a region frame is display on the screen, ON: display region frame; OFF: turn off region frame.
 - d. Source B: Set source of region B enable, which can be CH1~CH4.
- (2) Rectangle drawing menu can set cancel, 1: intersection, 1: non-intersection, 2: intersection, 2: non-intersection.
- a. Cancel: Turn off the current drawn region and cancel the condition.
 - b. A: intersection: The current drawn region is Region A trigger.
Condition: It will be triggered if region A intersects with source A waveform, if it not triggered then not intersected.
 - c. A: non-intersection: The current drawn region is Region A trigger.
Condition: It will be triggered if region A is not intersect with source A waveform, if it intersected then not triggered.
 - d. B: intersection: The current drawn region is Region B trigger.
Condition: It will be triggered if region B intersects with source B waveform, if it not triggered then not intersected.
 - e. B: non-intersection: The current drawn region is Region B trigger.
Condition: It will be triggered if region B is not intersect with source B waveform, if it intersected then not triggered.

The dot is displayed in the intersecting area. The diagonal line is displayed in the non-intersecting area. Clicking the region trigger frame on the screen can pop out the setting menu. Or it can touch the horizontal position and vertical position of region trigger frame in moving area to adjust the waveform's time base scale, volts/div scale. The region trigger frame will extend and compressed accordingly.

Not open region trigger as shown in Figure 7-11.

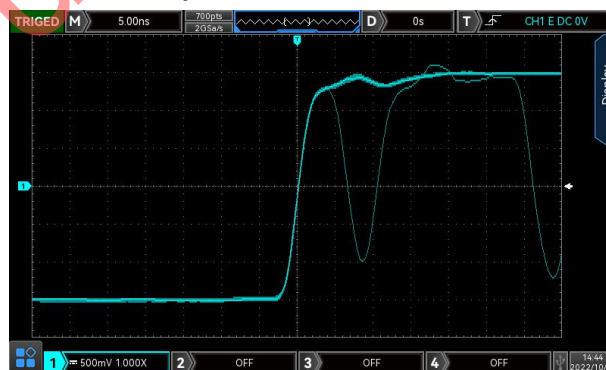

Figure 7-11

Open regional trigger in the position of abnormal signal, as shown in Figure 7-12.

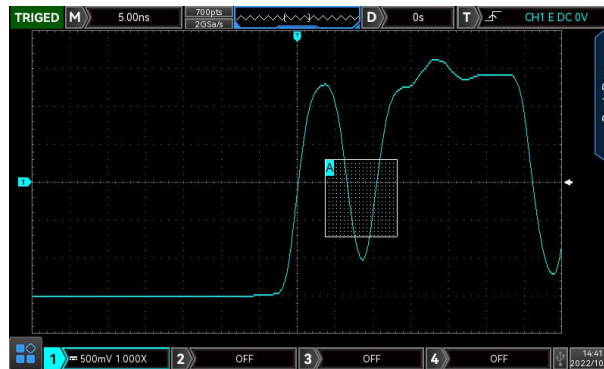

Figure 7-12

Note: If the currently selected region is already exists, then the current region trigger information will replace the original region trigger message and the region area trigger frame will be closed.

8. Automatic Measurement

- Parameter Measurement
- Automatic Measurement Menu
- All Parameter Measurement
- User-defined Parameter

8.1 Parameter Measurement

MSO/UP03000E series oscilloscope can automatically measure 36 kinds of parameters. It includes voltage, time and other.

① Voltage

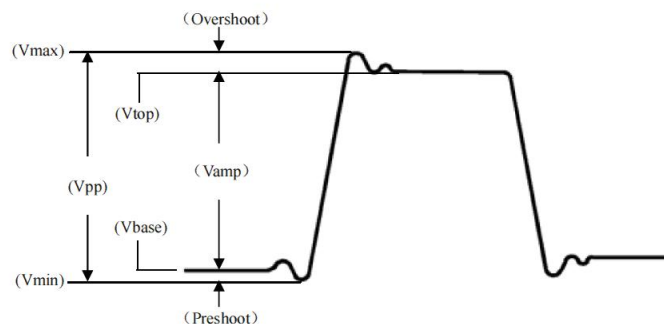

Max: The voltage from the highest point of the waveform to GND.

Min: The voltage from the lowest point of the waveform to GND.

High: The voltage value from the flat top of the waveform to GND.

Low: The voltage value from the bottom of the waveform to GND.

Middle: Half of the sum of the voltage values at the top and bottom of the waveform

Pk-Pk: Peak-to-peak value, the voltage value from the highest point to the lowest point of the waveform.

Amp: Voltage from top to bottom of the waveform.

Mean: The average amplitude of the waveform in the screen.

CycMean: Average amplitude of the waveform in one period.

DC RMS: The DC effective value.

CycRMS: The energy produced by the conversion of AC signal in a period, it corresponds to a DC voltage that generates equivalent energy.

AC RMS: The RMS value is the waveform which DC component has removed.

② Time



Period: Time between two consecutive, same-polarity edges of a repetitive waveform.

Frequency: The reciprocal of the period.

Rise time: Time needed for waveform amplitude rising from 10% to 90%.

Fall time: Time needed for waveform amplitude falling from 90% to 10%.

Rise delay: The delay time between the two rising edges of the primary and secondary signals.

Fall delay: The delay time between the two falling edges of the primary and secondary signals.

+Width: The width of a positive pulse at 50% amplitude.

-Width: The width of a negative pulse at 50% amplitude.

FRFR: Time from the first rising edge of source 1 to the first rising edge of source 2

FRFF: Time from the first rising edge of source 1 to the first falling edge of source 2

FFFR: Time from the first falling edge of source 1 to the first rising edge of source 2

FFFF: Time from the first falling edge of source 1 to the first falling edge of source 2

FRLF: Time from the first rising edge of source 1 to the last falling edge of source 2

FRLR: Time from the first rising edge of source 1 to the last rising edge of source 2

FFLR: Time from the last falling edge of source 1 to the last rising edge of source 2

FFLF: Time from the last falling edge of source 1 to the last falling edge of source 2

③ Other

+Duty: Ratio of positive pulse width to period.

-Duty: Ratio of negative pulse width to period.

OverSht: The ratio of the difference between the maximum value and the top value of a waveform to its amplitude.

PreSht: The ratio of the difference between the minimum value and the bottom value of a waveform to its amplitude.

Area: The algebraic sum of the time product of voltage at all points on the screen.

CycArea: The algebraic sum of the time product of voltage at all points in a cycle of waveform.

Phase: The phase difference between the master source and the slave source.

Pulse Count: Completed rising edge number on the screen.

8.2 Automatic Measurement Menu

Press **MEASURE** button on the front panel to enter the automatic measurement menu.

Automatic Measurement Menu (Page 1)

Function Menu	Setting	Description
Main Source	CH1,CH2,CH3,CH4, MATH	Select any of CH1,CH2,CH3,CH4, MATH for automatic parameter measurement
Slave Source	CH1,CH2,CH3,CH4, MATH	Select the second source that requires two channels for measurement
All Parameter	OFF	Turn off display frame of all parameter measurement
	ON	Pops up a display frame of all parameters on the waveform display area
User-defined		A user-defined parameter selection interface pops up on the waveform display area, adjust the Multipurpose knob to select and press the knob to confirm to show the parameter on the screen. Press the user defined key again to close the user-defined parameter choice box.
Measurement Statistical Analysis	OFF	Turn off measurement statistical function
	Extremum	Automatic calculates and displays the current user defined parameters, the average, maximum, and minimum. Only enabled when user defined parameters display on the screen.
	Difference	Automatic calculates and displays the current user defined parameters, the average, standard deviation and measurement times. Only enabled when user defined parameters display on the screen.

Automatic Measurement Menu (Page 2)

Function Menu	Setting	Description
Selection Indicator		Press <u>Multipurpose</u> knob to select the parameter of selection indicator.
Indicator	Off	Turn off the indicator function
	On	Indicate the physical significance of the indicator parameter intuitively by line
Delete		Clear all the user-defined parameter
Measurement	Screen area	The whole screen area

Window		
	Cursor area	<p>CURSOR horizontal time cursor area, user can set the cursor position according to your needs. And it can direct test the results in the cursor area.</p> <p>Note : Cursor area has an impact on all parameter measurement results of automatic measurement, and the CURSOR voltage measurement is invalid.</p>

8.3 All Parameter Measurement

Press **MEASURE** to pop out all parameter to measuring all parameters, as shown in Figure 8-1.



Figure 8-1

All parameters are always marked the same color with the current measuring channel (the main source). When "----" is shown, it indicates that the current source has no signal input, or the measurement result is not within valid range (too large or too small).

Parameter measurement supports parts of measurement testing in ROLL mode as shown in Figure 8-2.



Figure 8-2

8.4 User-defined Parameter

Press **MEASURE** to pop out user defined menu, as shown in Figure 8-3.

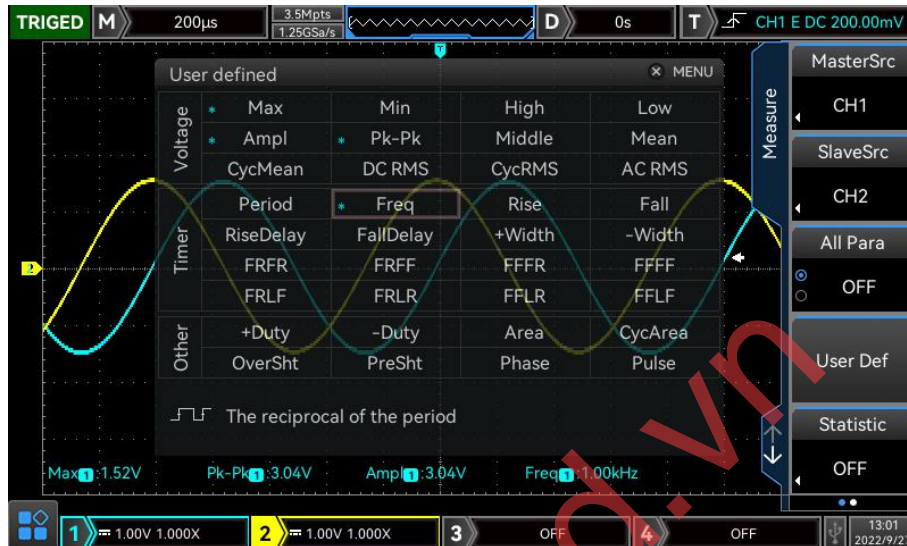

Figure 8-3

Rotating the **Multipurpose** knob to select parameter and press the knob to confirm. For every selected parameter, a * symbol will appear in front of the parameter. The user defined parameter will display on the bottom of the screen, it can measuring 5 parameters at the same time.

User can select difference value, extremum to perform measuring statistic to the user-defined parameters.

9. Cursor Measurement

The cursor can be used to measure the X axis value (time) and the Y axis value (voltage) of the selected waveform.

Press the **CURSOR** button to enter the cursor measurement menu.

Cursor measurement supports testing the multiple channels at the same time, and it also supports the measurement of callback waveform. The source and measurement type can be set.

(1) Source: Set the source for cursor measurement, it can be set to CH1-CH4, MATH or Ref A~Ref D

(2) Measurement type: supports three types of measurement, time, voltage and screen

- Time Measurement
- Voltage Measurement

■ Screen Measurement

9.1 Time Measurement

Press **CURSOR** key to enter the cursor measurement menu, select the type and the source to perform time measurement, as shown in Figure 9-1.

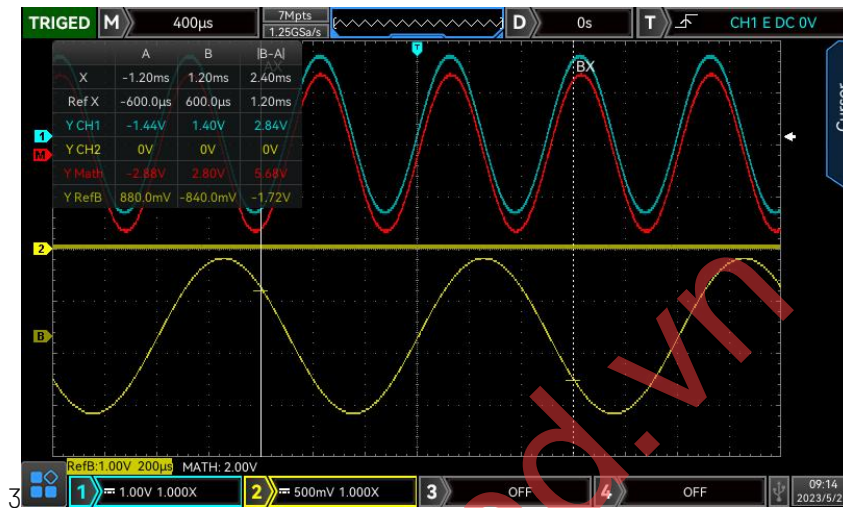

Figure 9-1

Display box of cursor measurement on the top left corner: "X" indicates the time test result of the channel, "Ref X" indicates the time test result of reference waveform, "Y" indicates the voltage test result between the opened channel and the intersection of the cursor. The cursor AX, BX horizontal position can be adjust by Multipurpose knob to realize the time measurement.

9.2 Voltage Measurement

The method of setting the time measurement is same as the time measurement. Measure the voltage value of each cursor source by change the vertical position of the cursor.

Press **CURSOR** key to enter the cursor measurement menu, select the voltage and the source to perform voltage measurement, as shown in Figure 9-2.

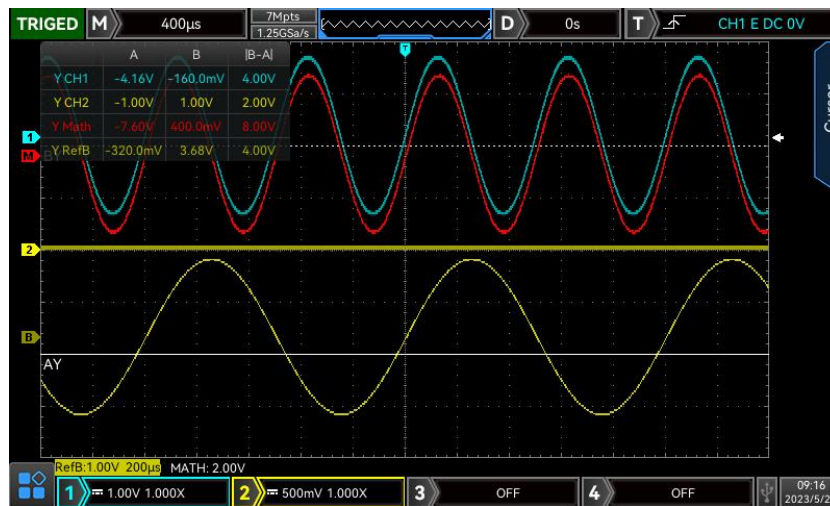

Figure 9-2

The upper left corner of the display area shows the cursor measurement information: Y represents the result of voltage measurement, Press Multipurpose knob to adjusting the vertical position of AY and BY to achieve the voltage measurement.

9.3 Screen Measurement

Screen measurement supports set the time cursor and the voltage cursor and measure the time and voltage at the same time.

Press CURSOR key to enter the cursor measurement menu, select the screen and the source to perform screen measurement, as shown in Figure 9-3.

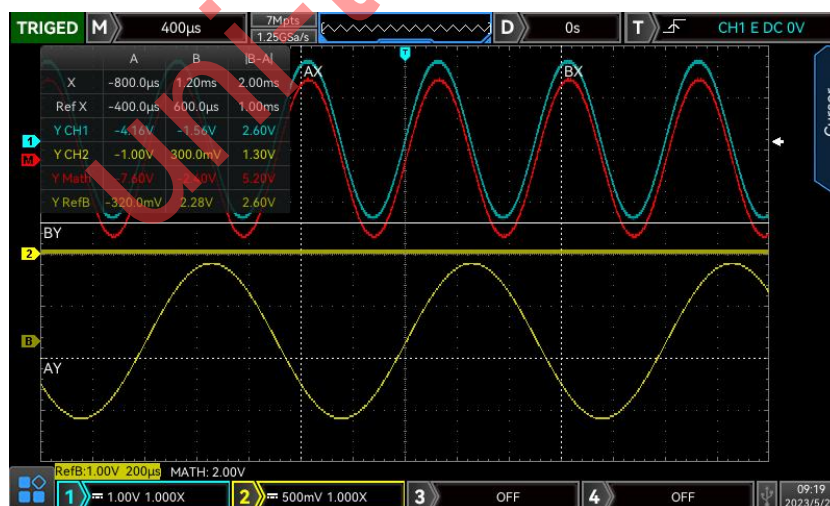

Figure 9-3

Display box of cursor measurement on the top left corner: "X" indicates the time test result of the channel, "Ref X" indicates the time test result of reference waveform, "Y" indicates the voltage test result. The cursor AX, BX, AY, BY vertical position can be adjust by Multipurpose knob to realize the time measurement and the voltage measurement.

10. Sampling System

Sampling is convert signal of analog input channel to discrete point via analog-digital converter (ADC).

Press **ACQUIRE** key on the front panel to enter sampling menu.

- Sampling Rate
- Acquisition Mode
- Storage Depth

10.1 Sampling Rate

(1) Sampling and Sampling Rate

Sampling is the oscilloscope sampling the input analog signal and then convert it to digital data.

Gathering the digital data to waveform record and stored in sampling memory.

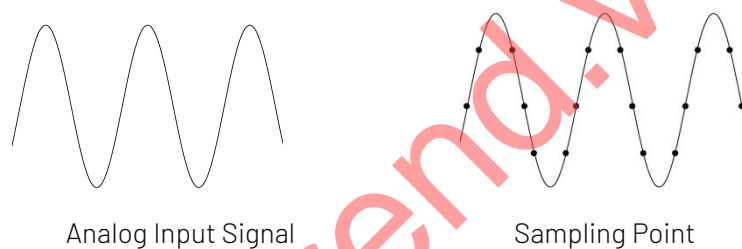

Sampling rate refers to the time interval between two sampling points. The maximum sampling rate of the MSO/UP03000E series is 2.5 GSa/s.

The sampling rate will be affected by the change of timing scale and storage depth. MSO/UP03000E oscilloscopes sampling rate is displayed in real-time in the status bar on the top of the screen. The horizontal **SCALE** knob can adjust the horizontal time base or modify the storage depth to change it.

(2) The influence of low sampling rate

- **Waveform Distortion:** Due to low sampling rate, the details of the waveform might be missing, the sampling waveform might be different than the actual signal. As shown in Figure 10-1.

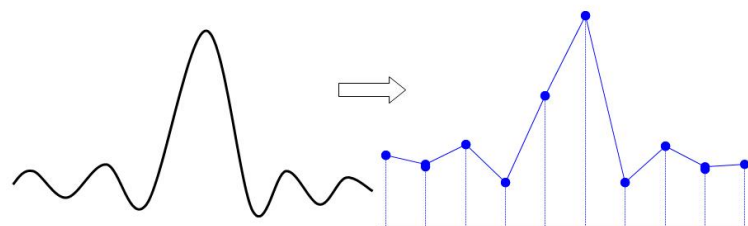

Figure 10-1

- **Wave Mixing:** When the sampling rate is 2 times lower than the actual signal frequency (Nyquist frequency), the frequency of the reconstructed signal will be less than the actual signal frequency. As shown in Figure 10-2.

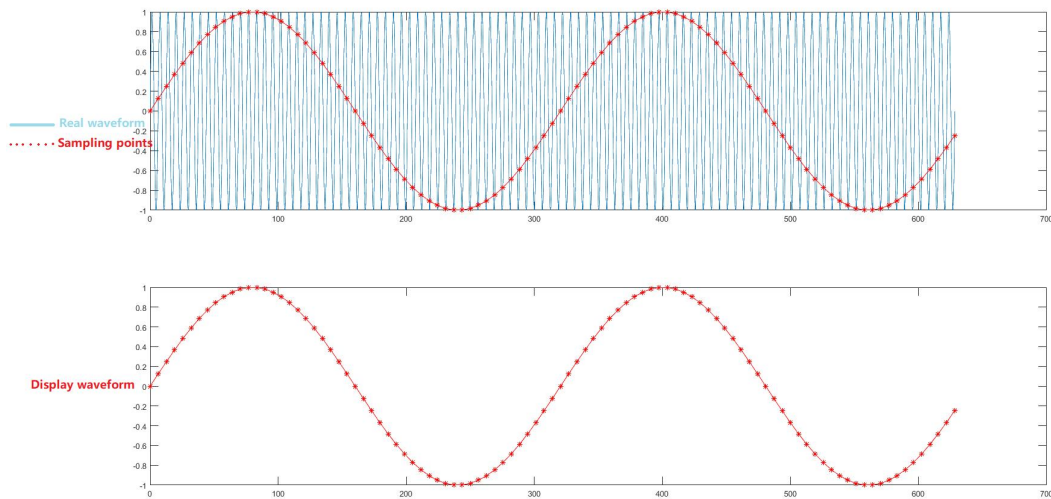

Figure 10-2

- **Waveform Lost:** Due to low sampling rate, the reconstructed waveform not reflect the actual signal. As shown in Figure 10-3.

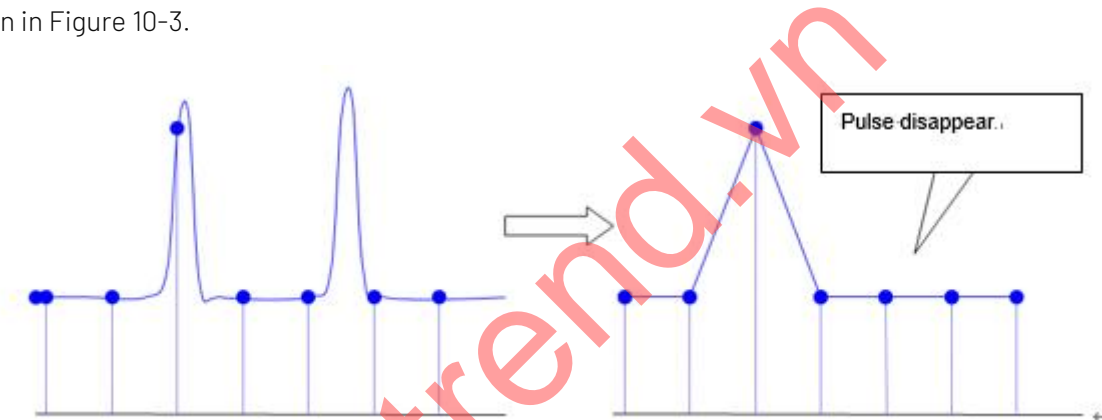

Figure 10-3

10.2 Acquisition Mode

Acquisition mode is used to control how to generate waveform from sampling points. Press **ACQUIRE** key to switch acquisition mode.

(1) Normal Sampling

The signal is sampled and reconstructed with equal time intervals. For most waveforms, this mode can perform the best display.

(2) Peak Sampling

The maximum and minimum values of the input signal are found at each sampling interval, and these values to display the waveform. The oscilloscope can acquire and display a narrow pulse, otherwise the narrow pulse might be missed in the normal mode. Noise might be enlarged in this mode.

(3) High Resolution

The oscilloscope will averaging the adjacent points of the sampled waveform, it can reduce random noise from the input signal and generate smoother waveform.

(4) Envelope

Sampling multi-amplitude waveforms, calculating all the sampling point at the same time which relative to trigger point and display its maximum and minimum. In general, envelope mode uses the peak detection mode for each single acquisition.

(5) Average

The oscilloscope obtains several waveforms to take the average, and display the final waveform. This method can reduce random noise.

By changing the acquisition mode setting to observe the waveform changes. If the signal contains large noise, when the average mode is not adopted and when the 32 times average mode is adopted, the sampled waveform is shown in the following figure.

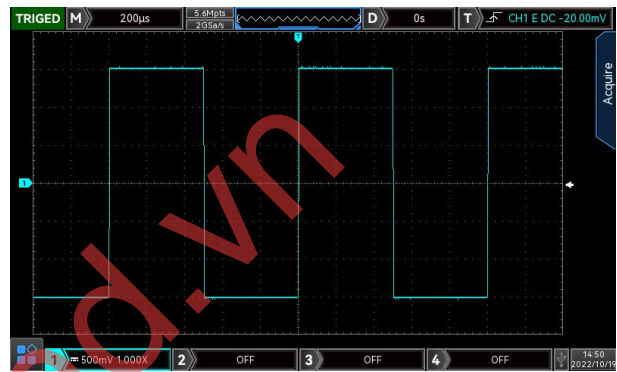
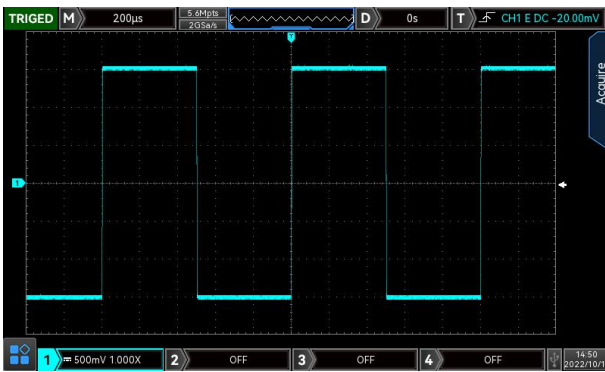

Waveform when the average mode is not adopted

Waveform when the 32 times average mode

Note: Average and high resolution uses different average methods. The former is multiple sampling average, the latter is single sampling.

10.3 Storage Depth

The storage depth is the number of waveform that can be stored in the oscilloscope during a trigger acquisition. It reflects the memory storage capacity of the acquisition.

The relation of storage depth, sampling rate and waveform length should meet the calculating formula:

$$\text{storage depth} = \text{sampling rate} \times \text{horizontal time base} \times \text{the number of grid of horizontal direction}$$

MSO/UP03000E the maximum storage depth 250 Mpts (single or sweep mode). In **ACQUIRE** menu, user can freely to set the storage depth to auto (limits to 7 M), 700, 7 k, 70 k, 700 k, 7 M, 14 M, 28 M, 56 M/70 M, 250M . The default setting is auto.

Note: Storage 70M, 250M can only be used in special conditions, the specific refer to Table 10-1.

Table 10-1

Storage Depth	Instrument Setup	Number of Opened Channel
	Arbitrary setup	Single channel is opened

70M	Single trigger	Single channel or multiple channels are opened
	Sweep mode	Single channel or multiple channels are opened
250M	Single trigger	Single channel is opened
	Sweep mode	Single channel is opened

11. Display System

11.1 Waveform Display

DISPLAY can set the display type of waveform, grid display type, grid brightness, waveform brightness, background brightness, duration time, color temperature, anti-color temperature, transparency of pop out dialog and default transparency.

(1) Display Type

- ① Vector: This mode provides the most realistic waveform in most cases and makes it easy to view the steep edges of the waveform (e.g. square wave).
- ② Point: Displays sampling points directly.

(2) Grid Type

Grid type can be set in the DISPLAY menu, which includes full display, grid, crosshair and frame.

(3) Grid Brightness

Grid brightness can be set in the DISPLAY menu, rotating multipurpose knob, jag dial or drag scroll bar to set the grid brightness. The default value is 50%.

(4) Waveform Brightness

Waveform brightness can be set in the DISPLAY menu, rotating multipurpose knob, jag dial or drag scroll bar to set the grid brightness. The default value is 50%.

(5) Backlight Brightness

Backlight brightness can be set in the DISPLAY menu, rotating multipurpose knob, jag dial or drag scroll bar to set the grid brightness, the default value is 50%.

(6) Persistence Time

Persistence time of waveform can be set in the DISPLAY menu, and it can set to the minimum value, 50ms, 100ms, 200ms, 500ms, 1s, 2s, 5s, 10s, 20s and infinite afterglow. The default value is the minimum.

(7) Color Temperature

Open color temperature in DISPLAY menu, it can intuitively reflect the probability of the occurrence of waveform signals. The waveform with high frequency is displayed in warm color, and the waveform with low frequency is displayed in cold color.

(8) Anti-color Temperature

Open color temperature in DISPLAY menu, anti-color temperature is the opposite of color temperature.

(9) Transparency of Pop out Dialog

Set the percentage of transparency of pop out dialog, which can set to 20% ~ 100%, 100% means non-transparent.

(10) Default Transparency

Restore the transparency of pop out dialog to default. The default value is 85%.

12. Storage and Recall

With the storage function, user can save the oscilloscope's settings, waveforms, and screen images to the oscilloscope or external USB storage devices, and load the saved settings or waveforms anytime. Press the **STORAGE** key to enter the storage function setting interface.

- Storage and Load Setting
- Waveform Storage and Load
- Print Screen
- Arbitrary Waveform Storage and Loading
- Picture Storage
- Preview Picture
- Saved Path

12.1 Storage and Load Setting

Table 12-1 Storage Menu Setting

Function Menu	Setting	Description
Type	Setting	
Disk	Local	Press save key, the setting will be saved in the oscilloscope
	USB	Press save key, the setting will be saved in external USB storage device
Filename		Press filename soft key to pop out virtual keyboard, touch screen or adjusting Multipurpose knob to select the letter and the numerical value. The default filename is UNIT001. Rotating Multipurpose knob to directly change the filename, the length limit is 79 characters.
Save		Performing the save setting, save the setting as .set format to the specified storage location.
Load		Loading the previously saved settings in the specified memory location, return the oscilloscope to the previously saved setting state.

12.2 Waveform Storage and Load

Table 12-2 Waveform Storage Menu

Function Menu	Setting	Description
Type	Waveform	
Source	CH1, CH2, CH3, CH4	Set which channel waveform to be saved.
Disk	Lock	Press save key, the waveform will be saved in oscilloscope.
	USB	Press save key, the waveform will be saved in external USB storage device.
	USB CSV	Press save key, the waveform will be saved as .csv format in external USB storage device, this format can use Excel software open on PC.
Filename		Press filename soft key to pop out virtual keyboard, touch screen or adjusting Multipurpose knob to select the letter and the numerical value. The default filename is UNIT001. Rotating Multipurpose knob to directly change the filename, the length limit is 79 characters.
Save		Performing the save setting, save the setting as .dat format to the specified storage location.

After the waveform is saved, user can select the **REF** key on VERTICAL control area to load waveform. Press **REF** key to enter recall menu of reference waveform as the following.

Table 12-3 REF Waveform Load Menu

Function Menu	Setting	Description
Reference	Ref-A, Ref-B, Ref-C, Ref-D	Select any of the four references to load waveforms.
Disk	Local	Press REF, loading the waveform form internal of the oscilloscope.
	USB	Press REF, loading the waveform from external USB storage device.
Load		Press REF to pop out the select file frame, adjusting Multipurpose to select file
Delete		Turn off the current REF waveform.

The callback REF waveform is shown in Figure 12-1.

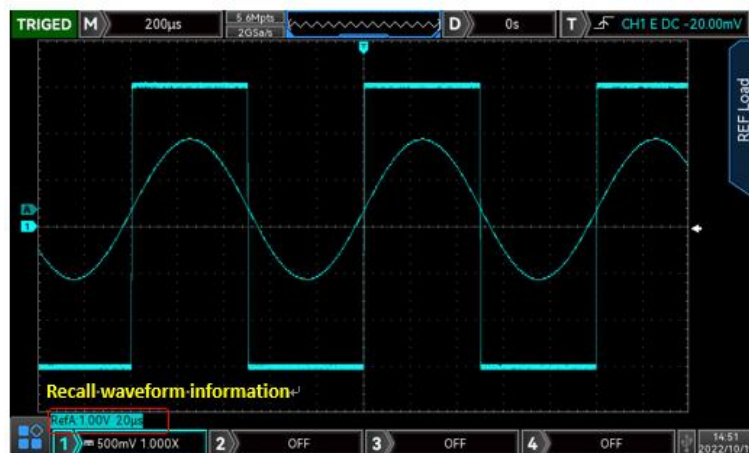

Figure 12-1

After the callback, the Ref waveform status will be displayed in the lower left corner, including time base scale and amplitude scale. User can use the VERTICAL and HORIZONTAL control knob to adjust the Ref waveform position on the screen and the time base scale and the amplitude scale.

Remark

- Only when the oscilloscope is connected to an external USB storage device, user can select the disk as USB, and then save the settings to the USB storage device. When the USB storage device is not connected, it will prompt "Detect USB device is failed."

12.3 Print Screen

The **PrtSc** key can be used to store the current screen in PNG format to an external USB storage device. The bitmap can be opened directly on the PC. This function can only be used when external USB storage device is connected.

12.4 Arbitrary Waveform Storage and Loading

Table 12-4 Arbitrary Waveform Menu

Function Menu	Setting	Description
Type	Arbitrary Waveform	
Source	CH1, CH2, CH3, CH4	Set which channel waveform to be saved.
Disk	Local	Press save key, the arbitrary waveform will be saved in oscilloscope
	USB	Press save key, the arbitrary waveform will be saved in external USB storage device
Filename		Press filename soft key to pop out virtual keyboard, touch screen or adjusting Multipurpose knob to select the letter and the numerical value. The default filename is UNIT001. Rotating Multipurpose knob to directly change the filename, the length limit is 79 characters.
Save		Performing the save setting, save the setting as .bsv format to the specified storage location.
Time Cursor		Set the storage range of arbitrary waveform, it can adjust by Multipurpose knob.
AWG CHA Output	AWG	Directly output the selected waveform on the screen into CHA/CHB of AWG and named "Arb.csv", the waveform file will not save.
AWG CHB Output	AWG	

After the arbitrary waveform is saved, use AWG function to loading, the operating refer to "[Select arbitrary waveform](#)".

12.5 Picture Storage

Table 12-5 Preview Menu of Picture Storage

Function Menu	Setting	Description
Type	Picture	
Format	Original picture	Oscilloscope screenshot is saved in the color displayed on the oscilloscope interface
	Save ink	Oscilloscope screenshot will turn the dark background into light color for storage, the purpose is saving ink to printing photos.
	Grayscale	Oscilloscope screenshot will turn the color picture to grayscale picture for storage.
	Save ink & grayscale	Oscilloscope screenshot will turn the dark background into light color, color picture to grayscale picture for storage.
Filename		Press filename soft key to pop out virtual keyboard, touch screen or adjusting Multipurpose knob to select the letter and the numerical value. The default filename is UNIT001. Rotating Multipurpose knob to directly change the filename, the length limit is 79 characters.
Save		Press save key, the current waveform will saved as .png format into external USB device.

12.6 Preview Picture

Table 12-6 Preview Menu of Preview Picture

Function Menu	Setting	Description
Type	Preview picture	
Preview		Press preview soft key to enter preview picture page, rotating Multipurpose knob to change the order of saved picture in USB and display the picture on the instrument's screen. The picture is on the top, press other functional key to automatically turn off preview picture.
Esc		Turn off the display of preview picture.

12.7 Saved Path

After a file or picture is saved on a USB storage device, a UNIT folder is automatically generated in the root directory of the USB storage device. In this folder, lower-level folders are automatically generated based on file types. The saved files are stored in these folders. The system automatically classifies files based on

their types and saves them to folders of their own types.

13. Auxiliary Function

Press the **UTILITY** key to enter the auxiliary function settings menu.

- System Function
- Recording Waveform
- Pass/Fail Test
- System Update
- Bode Diagram
- Web Access

13.1 System Function

(1) Automatic Calibration

Automatic calibration allows the oscilloscope to work optimally to obtain the most accurate measurements. Automatic calibration divide into analog channel calibration and LA calibration. This function can perform at any time, especially when the ambient temperature range reaches or exceeds 5 °C . Before performing the automatic calibration operation, make sure that the oscilloscope is operating for more than 20 minutes.

- a. Analog channel calibration: Only calibrating analog channel and calibrating time about 3 ~5min.
- b. LA calibration: Only calibrating digital channel and calibrating time about 3 ~5min.

(2) System Information

System Information can view the system information of the oscilloscope, which includes model, SN number, software version number, hardware version number, FPGA version number, manufacturer and website's QR code.

(3) Language

Language can set system language to English, simplified Chinese , traditional Chinese and Deutsch. By default, language display is the current setting.

(4) Interface Setting

Interface menu can set menu display time and transparency of pop out dialog. Menu display time can set to 5s, 10s, 20s or manual. The default setting is manual.

(5) Square Output

Square Output can set the output frequency of local square waveform, which can set to 10 Hz, 100 Hz, 1 kHz or 10 kHz. The default setting is 1 kHz.

(6) Frequency Meter

Frequency Meter can set the state of frequency meter (on/off). Source can set to CH1-CH4 or trigger source. When the frequency meter is enabled, source and frequency meter information in Freq pop out dialog will display on the top of the screen. When the frequency meter is disabled, Freq pop out dialog will disappear. Frequency meter is the counter of trigger event frequency in the trigger channel,

display as hardware 7 digitals frequency meter.

(7) AUX Output Selection

Output Selection set which signal can output via AUX OUT port, it can select "trigger" or "pass/fail test". When "trigger" is selected, AUX OUT port exports trigger synchronizing signal. When "pass/fail test" is selected, AUX OUT port exports the output signal of pass /fail test. The default setting is "trigger".

(8) Automatic Setting

Auto can set hold or auto mode. Hold which is keep the setting before AUTO; AUTO which is freely to set and not keep the setting, such as channel setting, sampling setting, trigger setting and activated channel.

- a. Channel setting: In hold mode, remain the bandwidth limit and inverse phase, restore coupling (ground) and volts/div scale to the default value.
- b. Sampling setting: In hold mode, remain the sampling mode and average time, restore the storage depth to automatic.
- c. Trigger setting: In hold mode, remain source and trigger coupling setting, other setting will restore to "edge trigger, automatic, rising edge."
- d. Signal setting: Remain the channel state.

(9) Clear Data

Clear can delete stored waveform and the setting file in the oscilloscope.

(10) SCPI Port

SCPI port configuration can allocate USB and UART. The default setting is USB.

(11) Internet Setting

When the device is connected with available internet, IP setting can set the IP, subnet mask and gateway of the oscilloscope.

- a. Mode: Switch IP acquire mode, it can set manual or auto.
Manual: Set IP address, subnet mask and gateway by manual
Auto: Only for checking IP address, subnet mask and gateway
- b. IP Address: IP address format is nnn.nnn.nnn.nnn, the first nnn range is from 1 to 233, the second nnn range is from 0 to 255. It is recommended that user can consult network administrator for an available subnet mask.
- c. Subnet mask: The format is nnn.nnn.nnn.nnn, the nnn range is from 0 to 255. It is recommended that user can consult network administrator for an available subnet mask.
- d. Gateway: The format is nnn.nnn.nnn.nnn, the first nnn range is from 1 to 255, the second nnn range is from 0 to 255. It is recommended that user can consult network administrator for an available subnet mask.

(12) RTC Setting

RTC can set the time of the oscilloscope. User can separately set year, month, date, hour and second. Switch the setting item by key. After the setting is completed, the oscilloscope will display the setting time.

Note: If RTC time is networking and synchronizing the internet time, the adjustment will not take effect.

(13) Boot Loading

Boot Loading can set whether to automatically set the settings before the shutdown when the oscilloscope starts up. It can set the last setting or the default setting.

- Last setting: Load all the settings before shutdown;
- Default setting: Restore the oscilloscope to the default factory setting after starting up.

(14) Power-on Mode

Set the power-mode of the oscilloscope, it can set always off, always on and last status.

- Always off: After the power switch on the rear panel of the oscilloscope is turned on, user should press the soft boot key by manual on the front panel of the oscilloscope. Then the oscilloscope will power on.
- Always on: After the power switch on the rear panel of the oscilloscope is turned on, the oscilloscope will directly power on.
- Last status: After the power switch on the rear panel of the oscilloscope is turned on, the oscilloscope will rebooting with the last shut down status. If the last shut down is turned off by soft key, then the oscilloscope should press the soft key to power on; if the last shut down is turned off directly, then it will power on directly.

(15) Option Function

Option Function is the entrance of activating option, it can select to activate single option as shown in Figure 13-1 or activate all as shown in Figure 13-2. All options supports free trial for 145 hours as shown in Figure 13-1. After free trial, the option should purchase to use. Activating option should select the purchased option and acquire the corresponding license and save it into USB and then insert to the instrument. MSO/UP03000E option supports UART, I²C, SPI, CAN, CAN_FD, LIN, FlexRay, bode diagram and LA.





Figure 13-1



Figure 13-2

13.2 Recording Waveform

Recording Waveform can set to record the waveform, this function includes recording setting (REC SET), record , stop  and display .

(1) Recording Setting

Set the parameter of recording waveform, which includes recording interval, end of frame and playback delay.

- a. **Recording interval:** Set time interval between each frame of waveform recording.
- b. **End of frame:** The waveform recording will automatically stop recording when it reaches the end frame.
- c. **Playback delay:** Set time interval between each frame of playback waveform.



(2) Record

Start to recording or press  to directly recording.

(3) Stop

Stop the waveform recording or press  to stop it.

(4) Play

Start to play the waveform playback or press  to start it. When the waveform play back is playing, press  to pause it. Adjusting Multipurpose knob (jag dial or numeric keyboard) to jump to the specified frame.

(5) Quick Record

Quick record is continuously recording waveform for improving waveform capture rate; in quick record mode, the waveform will not displayed on the screen. The waveform can only played when the recording is finished. Quick record can set to on or off.

(6) Save the recording content

Table 13-1 Record Storage

Function	Setting	Description

Menu		
Type	Waveform	Save record waveform into USB. Open and play analysis in the analysis software of the upper computer.
	Picture	Save record waveform as picture format into USB. Open and play analysis in the analysis software of the upper computer.
Disk	USB	Press save key, the setting will save into external USB storage device.
Filename		Press filename soft key to pop out virtual keyboard, touch screen or adjusting Multipurpose knob to select the letter and the numerical value. The default filename is UNIT001. Rotating Multipurpose knob to directly change the filename, the length limit is 79 characters.
Save		Press save key, save the setting to the specific storage position.

Note: Each stored frame is related to play delay when save recorded picture. The maximum picture storage is 10000.

13.3 Pass/Fail Test

Pass/Fail can set the template and judgment condition to perform Pass/Fail test, which can set allow to test, output, information source, operating, template and stop setting.

The Pass/Fail uses a template to detect whether the input signal within the range of the template requirements. If the input signal exceeds the limited range of the template, it is judged as failed.

(1) Allow to test

Allow to test is to select whether perform test or not. ON: turn on to set and perform the test; OFF: not allow to perform the test.

(2) Output

Set which signal output by AUX port, which can set pass or fail.

- a. **Fail:** Set the AUX port on the rear panel of the oscilloscope to output pulse when it is "fail" and produce beeps.
- b. **Pass:** Set the AUX port on the back panel of the oscilloscope to output pulses when it is "pass" and produce beeps.

Note: AUX output selection needs to switch to Pass test.

(3) Display Information

Set whether the test result is display on the right corner of the screen, as shown in the following figure.

```

Pass Wfs: 26
Fail Wfs: 2
Total Wfs: 28

```

Total Wfs represents the total frame number that has tested;

Pass Wfs represents the frame number that has passed;

Fail Wfs represents the frame number that has failed.

(4) Stop Setting

Set the stop conditions for pass/fail test, and automatically stop the test when the condition is met.

Table 13-2 Condition Setting

Function Menu	Setting	Description

Stop Type	Pass Count	Set the Pass/Fail function to stop the test automatically after it reaches the specified threshold count of pass.
	Fail Count	Set the Pass/Fail function to stop the test automatically after it reaches the specified threshold count of failure.
Condition	>=, <=	Set stop condition
Threshold		Adjusting Multipurpose knob to set the threshold of stop condition. The default value is 1.

(5) Template Setting

Template setting is to set the template of pass/fail test. CH1 is used as the reference waveform to create a template by default. If the waveform is within the template range, then the output is successful. If the waveform exceeds the template range, then the output is failed.

Table 13-3 Template Setting

Function Menu	Setting	Description
Reference Waveform	CH1, CH2, CH3, CH4, Local REF, USB REF	Specify a channel waveform in CH1 ~ CH4, DSO REF, USB REF and plus the horizontal and vertical tolerance as the conditions for creating a template
Horizontal Tolerance	1~100	Adjusting Multipurpose knob to select the range of horizontal tolerance. The default value is 5.
Vertical Tolerance	1~100	Adjusting Multipurpose knob to select the range of vertical tolerance. The default value is 5.
REF Loading		Loading reference waveform as the reference waveform for creating template.

(6) Operating

After all above setting is completed, press operating key to run the pass/fail test.

13.4 System Update

This series can use USB to update program. It's convenient and flexible.

USB update has two methods. Method 1: Turn on the oscilloscope to detect USB update; Method 2: utility-update-detect USB update file and select the file to update. The specific steps refer to the following.

Method 1

- a. Press **UTILITY** key to enter auxiliary function menu, press system key to check the system information to find the model name, software and hardware version information.
- b. Download the update file from UNI-T official website or ask UNI-T distributor to provide the update file. The update file is the same as the model and hardware version of the instrument, the software version is higher than the version of the instrument. Save the update file in the root directory of the USB.
- c. The instrument is in shut down state. Insert USB and boot the instrument, wait it to enter the upgrade interface, and then press F1 to confirm to update.
- d. Updating process requires about 5min. After it finished, turn off the instrument and plug out USB.

- e. Reboot the instrument to check whether the system information is same as the provided version. If it is the same that means the update is successful.

Method 2

- a. Press **UTILITY** key to enter auxiliary function menu, press system key to check the system information to find the model name, software and hardware version information.
- b. Download the update file from UNI-T official website or ask UNI-T distributor to provide the update file. The update file is the same as the model and hardware version of the instrument, the software version is higher than the version of the instrument. Save the update file in the root directory of the USB.
- c. Turn on the oscilloscope and insert UBS into the oscilloscope. Press Utility- Upgrade to check the update file.
- d. Select the update file and confirm to upgrade.
- e. After the upgrade is finished, reboot the oscilloscope to complete the update.

Note: Please ensure that the power is not turned off during the entire upgrade process, it is to avoid failure to reboot due to incomplete system upgrade content.

13.5 Bode Diagram

Bode diagram function is for the frequency respond curve of the device under test DUT, as shown in Figure 13-3. In scanning. During the scan, the oscilloscope configures the function/arbitrary waveform generator output signal and connects to the DUT, then compares the DUT input signal with the DUT output signal.

Each frequency will measuring gain (G) and phase (p) and drawing in the frequency respond bode diagram. When the loop respond analysis is completed, user can move cursor on the diagram for checking the gain and phase value of each frequency. User can also adjust the figure scale and displacement setting for amplitude and phase graphs.



Figure 13-3

- 1: Gain scale is display based on the setting gain scale and gain displacement.
- 2: Phase Margin (PM) value is the difference value between the phase measurement corresponding to the frequency point with a gain of 0dB and 0°.
- 3: Gain Margin (GM) value is the difference value between the gain measurement at 0dB and the frequency point at 0° phase. That is $GM = 0\text{db} - \text{gain measured value}$.
- 4: Frequency scale is display based on start frequency and stop frequency of the scanning.
- 5: Scanning the gain result curve.
- 6: Scanning the phase result curve.
- 7: Cursor, please refer to chapter "cursor".
- 8: The gain value, phase value and frequency value of the intersection of the two cursor lines with the gain curve and the phase curve.
- 9: Phase scale is display based on the setting phase scale and phase displacement.

(1) Operating

Operating can turn on/off bode diagram function.

(2) Scanning Mode

Scan Mode can set single scanning or continuous scanning

(3) Scanning Setting

Scan can set scanning parameter, which is start frequency, stop frequency, scanning point, amplitude mode, amplitude setting, DC displacement and source impedance, as shown in Figure 13-4.

- a. Start frequency: Set start frequency of the scanning, the range can set to 50 Hz ~ 50 MHz.
- b. Stop frequency: Set stop frequency of the scanning, the range can set to 60 Hz ~ 50 MHz.
- c. Scanning point: Set the scanning point, the higher the number of points the higher the scanning resolution. The range can set to 1~1000.
- d. Amplitude mode: Set the amplitude of scanning signal, which can be fixed amplitude or variable amplitude.

- e. Amplitude setting: In fixed amplitude mode, it can only set one fixed amplitude; in variable amplitude, signal at different frequency can set different amplitude, the range can set to 10 mV ~ 3 V.
- f. DC displacement: Set the offset of the scanning signal, the rang can set to -1V~1V.
- g. Source impedance: Set source load, which can be 50 Ω or high resistance.

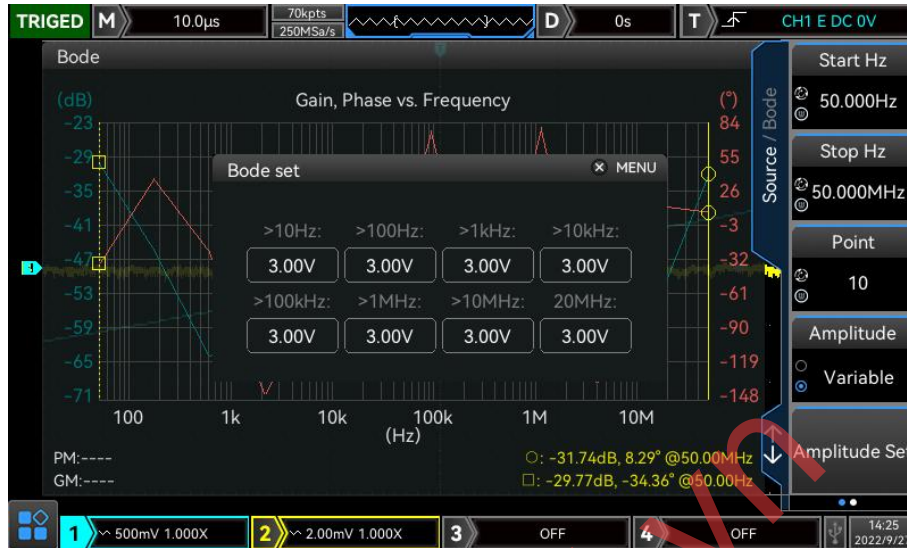

Figure 13-4

(4) Channel Selection

Channel Selection can set the input and output signal channel of DUT.

- a. DUT input: Select the input signal channel of DUT, which can be CH1~CH4.
- b. DUT output: Select the output signal channel of DUT, which can be CH1~CH4.

(5) Display Setting

Set the display parameter, which can set automatic setting, gain scale, gain displacement, phase scale, phase displacement, start frequency, stop frequency, gain display and phase display.

- a. Automatic setting: The oscilloscope is automatically to set gain scale, gain displacement, phase scale, phase displacement, start frequency, stop frequency based on the amplitude curve and phase curve.
- b. Gain scale: Set the gain scale in waveform window, the range can set to 1 dB ~ 500 dB.
- c. Gain displacement: Set the gain displacement in window frame, the range can set to -250 dB ~ 250 dB.
- d. Phase scale: Set the phase scale in window frame, the range can set to 1° ~ 180°.
- e. Phase displacement: Set the phase displacement in window frame, the range can set to -180° ~ 180°.
- f. Start frequency: Set the start frequency display on the horizontal axis in window frame, the range can set to 50 Hz ~ 50 MHz.
- g. Stop frequency: Set the stop frequency display on the horizontal axis in window frame, the range can set to 60 Hz ~ 50 MHz.
- h. Gain display: Set whether display gain data and the relevant information in window frame, which can set ON or OFF.
- i. Phase display: Set whether display phase data and the relevant information in window frame, which can set ON or OFF.

(6) Cursor

MSO/UP03000E supports using the cursor to assist in measuring the bode chart curve. It can set

cursor state and mode.

- a. State: Turn on, off cursor.

Turn on: Two cursors will display in bode diagram curve. Using Multipurpose knob or touch gesture to move cursor position. The data list will display its scanning point information and the phase value, gain value and frequency value intersecting with the cursor will display on the right bottom corner.

Turn off: Hide the cursor, the relevant measured value will not display on the right bottom corner.

- b. Mode: Set cursor moving mode, which can set to independent or track. Press Multipurpose knob to switch the mode.

Independent: Two cursors can move independently.

Track: Two cursors can move in the same time.

(7) Data List

Data list displays all scanning point information scan by bode diagram as shown in Figure 13-5, which includes serial number, frequency, amplitude, gain and phase information. It can set turn on or off.

- a. ON: Turn on the left data list pop out frame. When the cursor is turned on, using Multipurpose knob or touch to select scanning point, cursor on the right figure will move to the corresponding position.

- b. OFF: Turn off pop out frame.

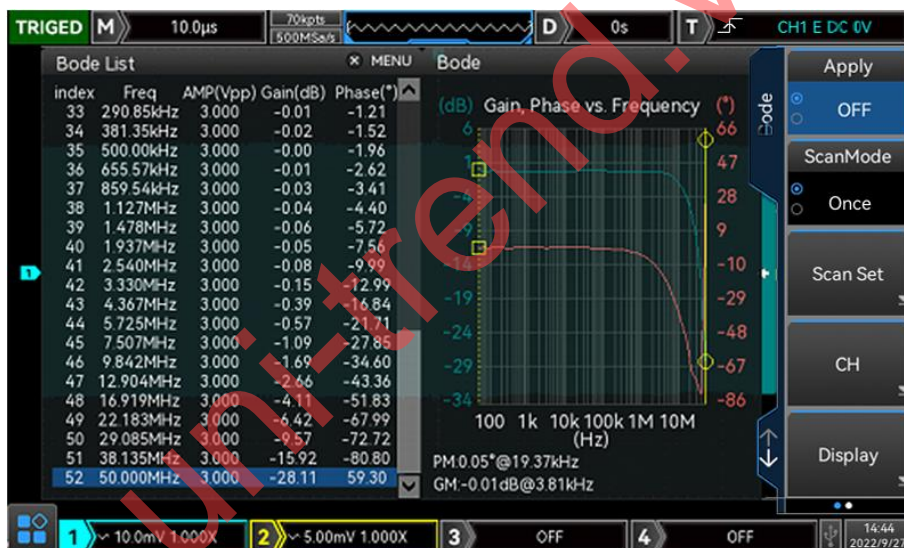

Figure 13-5

(8) Data

Data can set save and load the scanning data information of bode diagram, which is set the file name, save or load the file.

- a. Input name: Touch or press the input key to pop out the virtual keyboard, touch to select or adjust Multipurpose knob to select letter and digit.
- b. Storage: Save bode diagram's scanned data as the .csv format into USB. Insert USB to set it.
- c. Reload: Reload bode diagram's scanned data from USB. Insert USB and it should has the relevant data.

(9) Wiring Diagram

Before using bode diagram function, it should proper to set loop connecting as shown in Figure 13-6. User can see the wiring explanation and wiring connecting figure in pop out window.

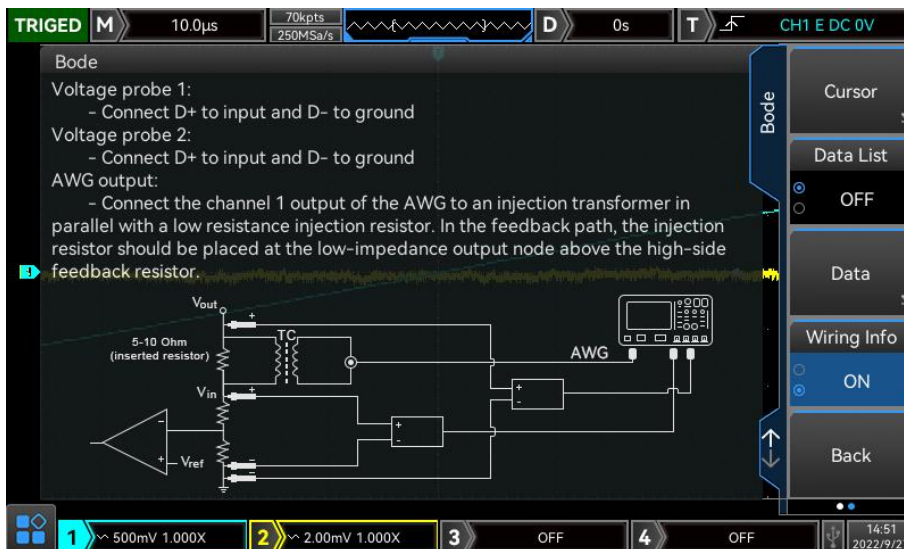

Figure 13-6

13.6 Web Access

(1) Access Local Area Network

The computer and the oscilloscope should be under the same LAN. Check the IP address through the UTILITY menu of the oscilloscope, and then the browser accesses the oscilloscope by IP: 9000 port.

Example:

Computer IP: 192.168.42.3

Oscilloscope IP: 192.168.42.12

PC browser using 192.168.42.12:9000 to access the oscilloscope

View the basic information, as shown in Figure 13-7.

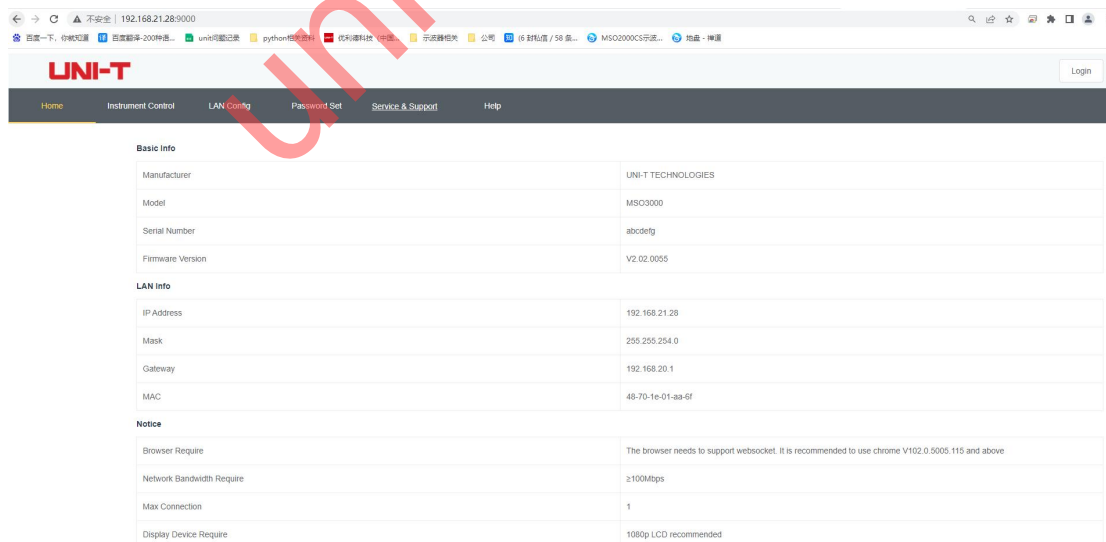

Figure 13-7

Log in to check the instrument setting, internet setting and password setting. Web user name and password see Utility/System Information. View waveform and control, as shown in Figure 13-8.

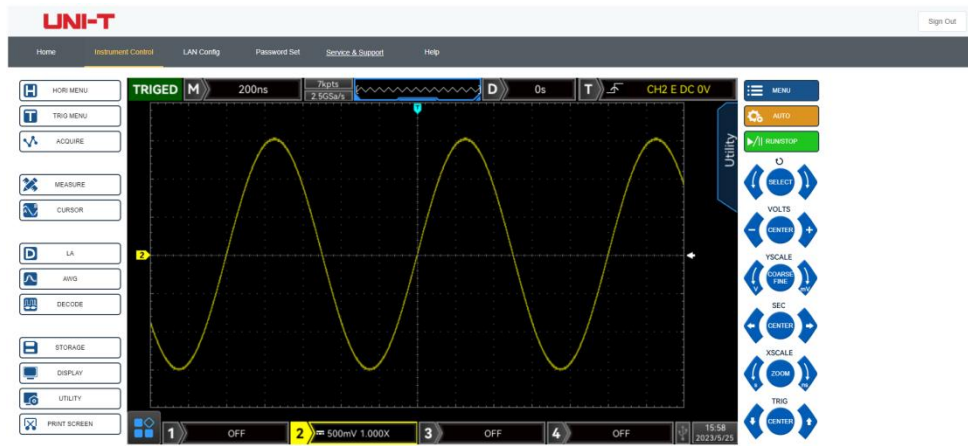

Figure 13-8

In Web page, click the corresponding key and knob to control the oscilloscope. Multiple operating can be set in screen part of the oscilloscope, such as

- drag waveform cursor to adjust the vertical position of the waveform; drag the trigger position cursor to adjust the trigger position.
- click the channel to switch turn on/off the current channel
- use mouse wheel to adjust the amplitude volts/div scale in the channel
- use mouse wheel to adjust the time base scale in time base position (M)
- slide left right to adjust the pretrigger position in D display area. Click the trigger delay to move the pretrigger position to the center of the screen.
- click menu to adjust the setting option directly

The internet setting information of the oscilloscope, as shown in Figure 13-9.

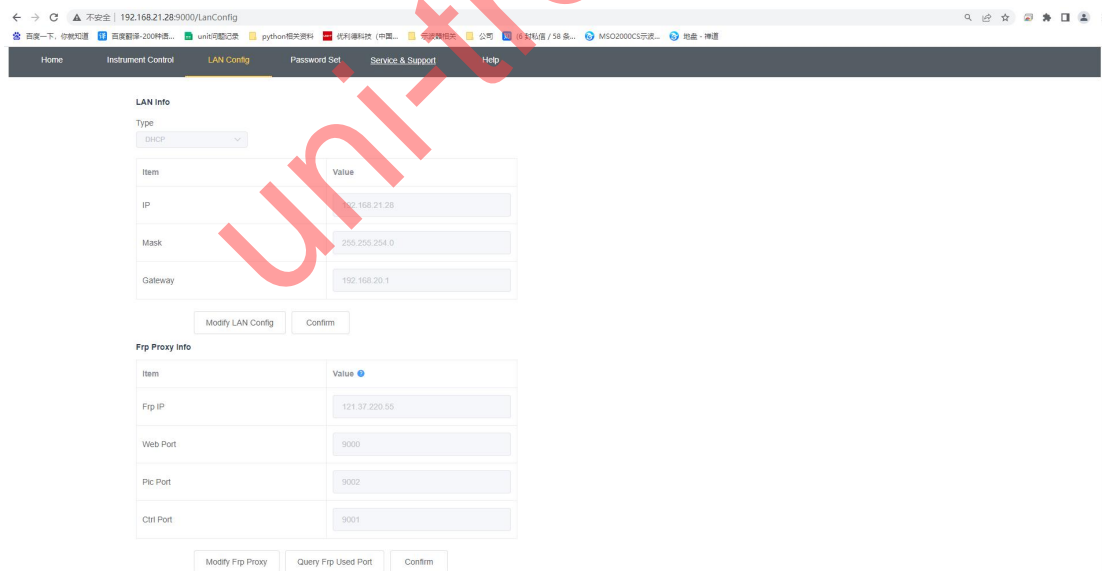

Figure 13-9

(2) Access Outer Network

- Plug the network cable into the oscilloscope and the network can be access internet
- Open frp proxy service on the server
- Configure the oscilloscope frp proxy IP and port
- The browser can access the proxy IP:9000 port, and the access interface LAN is consistent.

Note: This oscilloscope uses frp intranet penetration way to achieve external network access. frp use

version is 0.34.0. This machine with frp-0.34.0 client, it need use with the server, the server needs to open frp server, the client connects to the frp server port is 7000, so the server needs to configure bind_port = 7000

(3) Network Parameter Setting

a. Local area network setting

It should log in to access the internet setting of the oscilloscope, web user name and password see Utility/System Information. The setting interface as shown in Figure 13-10.

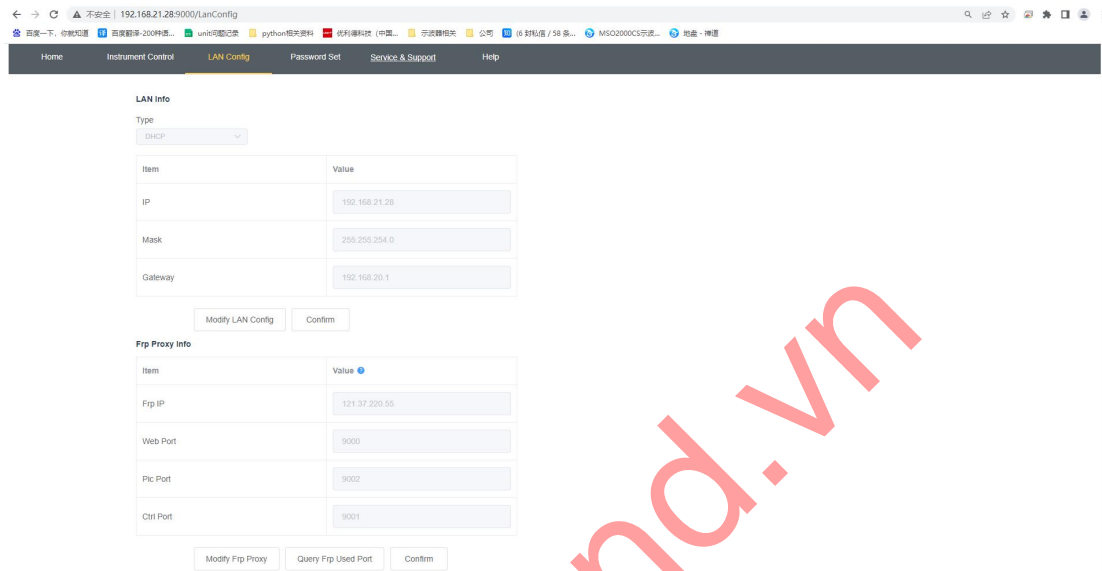

The screenshot shows a web browser window with the URL 192.168.21.28:9000/LanConfig. The page has a navigation bar with links: Home, Instrument Control, LAN Config (active), Password Set, Service & Support, and Help. The main content area is divided into two sections:

LAN Info

Type: DHCP (dropdown menu)

Item	Value
IP	192.168.21.28
Mask	255.255.254.0
Gateway	192.168.20.1

Buttons: Modify LAN Config, Confirm

Frp Proxy info

Item	Value
Frp IP	121.37.229.55
Web Port	9000
Pic Port	9002
Clif Port	9001

Buttons: Modify Frp Proxy, Query Frp Used Port, Confirm

Figure 13-10

Internet information setting includes IP address acquisition method (dhcp/static), local IP address, subnet mask and gateway. If IP setting is dhcp, it not need to fill in the configuration IP address, subnet mask and gateway, click confirmation directly. If IP setting is STATIC, it should fill in the correct IP address, subnet mask and gateway, and then click confirmation, as shown in Figure 13-11.

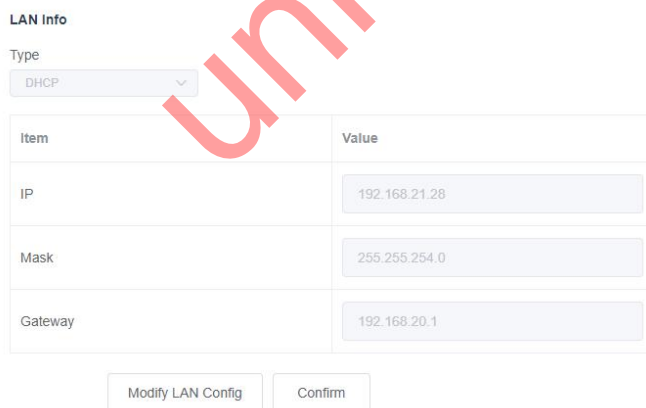

The screenshot shows the LAN Info section of the web interface. The Type is set to DHCP. The configuration fields are as follows:

Item	Value
IP	192.168.21.28
Mask	255.255.254.0
Gateway	192.168.20.1

Buttons: Modify LAN Config, Confirm

Figure 13-11

Click the confirmation after the input is completed, it can continuous to access according to the new modified IP address information (in correct configuration).

b. frp proxy network information setting

The setting interface setting as shown in Figure 13-12.

The screenshot shows the 'LAN Config' page with a navigation bar at the top containing 'Home', 'Instrument Control', 'LAN Config', 'Password Set', 'Service & Support', and 'Help'. Below the navigation bar, there are two main sections:

LAN info

Type:

Item	Value
IP	192.168.21.28
Mask	255.255.254.0
Gateway	192.168.20.1

Buttons:

Frp Proxy info

Item	Value
Frp IP	121.37.220.55
Web Port	9000
Pic Port	9002
Ctrl Port	9001

Buttons:

Figure 13-12

It includes frp proxy network server IP address, web_port, pic_port proxy port and ctrl_port proxy port. Click to change frp setting, that is to edit proxy IP address, web_port, pic_port, ctrl_port, as shown in Figure 13-13.

The screenshot shows a close-up of the 'Frp Proxy Info' form. It contains a table with the following data:

Item	Value
Frp IP	121.37.220.55
Web Port	9000
Pic Port	9002
Ctrl Port	9001

Buttons:

Figure 13-13

Click the confirmation after the input is completed, it can continuous to access according to the new modified frp proxy IP address information (in correct configuration).

Notes:

If each oscilloscope is connect with the same frp server, then web_port, pic_port, ctrl_port of each oscilloscope should be consistent, otherwise frp proxy fails and cannot access.

If frp proxy is modified, it cannot access by local area network IP: 9000. If user need to recover the normal access, press the DEFAULT button on the oscilloscope panel to reset the configuration and then use IP: 9000 port to access.

(4) Password Setting

Password setting is for the user account to log in. After the user changes the login password, the user needs to use the new password for the next login. If you forget the password, reset the password by pressing the DEFAULT button on the oscilloscope panel.

14. Protocol Decoding

MSO/UP03000E performs common protocol decoding for input signal of analog channel, which includes RS232, I²C, SPI, CAN, CAN-FD, LIN and FlexRay. User can easily find error, debug hardware, and speed up development progress through protocol decoding. It guarantee high speed and quality completion of projects.

- RS232 Decoding
- I²C Decoding
- SPI Decoding
- CAN Decoding
- CAN-FD Decoding
- LIN Decoding
- FlexRay Decoding

14.1 RS232 Decoding

RS232 interface is an asynchronous transmission standard interface developed by the Electronics Industry Association. It is usually available in DB-9 or DB-25 applications. It is suitable for communication with data transmission rate in the range of 0 ~ 29491200/s and is widely used in microcomputer communication interface. The data to be sent is combined into a specific set of serial bits according to the protocol rules and sent in an asynchronous serial.

The data sent each time is according to the following rules: send one start bit firstly, then 5 to 8 is data bits, the next is optional parity bits, and the last is one or two stop bits. The number of data bits is agreed upon by the two communicating parties and can be 5 to 8 bits, no parity bits, or select odd or even parity. Stop bit can select one or two bits. In the following description, one data string transmission is referred to as one frame, as shown in Figure 14-1.

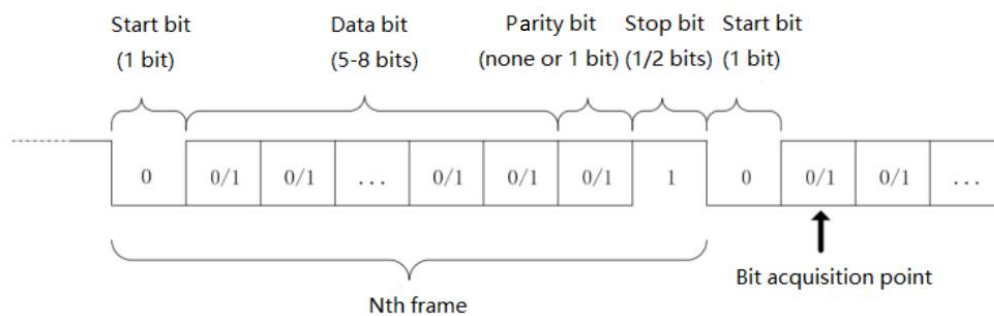

Figure 14-1

(1) Bus Decoding

Bus decoding menu can set bus status, display format and event list and position.

- a. Bus status: set whether bus decoding is enabled.
- b. Display format: set the display format of bus decoding, it can be hexadecimal, decimal, binary system or ASCII (Only for RS232).
- c. Event list: display data after decoding in data line, the corresponding line number, time, data and parity data in list format for observing the long decoded data.
- d. Vertical position: adjusting Multipurpose knob to change the bus position, which can set the range to 10~190.

(2) Information Source

Set the trigger source, which can be CH1, CH2, CH3, CH4 or D0-D15. The current selected source will display on the right corner of the screen. The source supports display and select digital channel only when the digital channel is opened in LA.

Note: Only the channel that has been connected to the signal, select it as the trigger source that can get the stable trigger and correct decoding.

(3) Polarity

Press Polarity key to select the trigger polarity to positive or negative.

- a. Negative: opposite logic level polarity, i.e. high level is 0 and low level is 1.
- b. Positive polarity: normal logic level polarity, i.e. high level is 1, low level is 0.

(4) Parity

Set the parity mode of data transmission. It can select no parity, even parity or odd parity.

(5) Bit Width

Specify the data bit width of RS232 protocol signal to be decoded. 5 bits, 6 bits, 7 bits, 8 bits can be selected.

(6) Bit Order

Specify whether the data bits of the RS232 protocol signal to be decoded is high bit at the front (MSB) or low bit at the front (LSB). MSB or LSB can be selected.

- a. MSB: The high bit of data is transmitted first.
- b. LSB: The low bit of data is transmitted first.

(7) Stop Bit

Stop bit which is set stop bit for each data frame. It can set to 1 bit or 2 bits.

(8) Baud Rate

When RS232 is asynchronous transmission communication, there is no accompanying clock signal during data transmission. In order to solve the determination of data bits, the protocol stipulates that both parties of communication should agree on the bit rate. Usually, the bit rate is defined as the number of bits that can be transmitted in 1s. For example, 9600 bps means 9600 bits can be transmitted in 1s. It should note that the start, data, parity and stop bits are all counted as bit, so the baud rate does not directly equal to the effective data transmitting rate. The oscilloscope will sample the bit values according to the setting baud rate.

Baud rate can be 2400 bps, 4800 bps, 9600 bps, 19200 bps, 38400 bps, 57600 bps, 115200 bps or user-defined. The baud rate can be adjusted via the Multipurpose knob or jog dial when user-defined is selected.

It is recommended to set the baud rate based on the hardware and software of RS232 communication protocol. Due to the basic model of this transmission protocol, RS232 protocol is usually used for short distance (under 20m) and low speed (under 1 Mbps) transmission. Communication beyond this range is

susceptible interference and unreliable.

14.2 I²C Decoding

I²C trigger usually used to connecting micro-controller and peripheral equipment, it's widely applied in micro-electronics area. This bus protocol has two lines to transmit, one line is serial data SDA, and another line is serial clock SCL. Communicated by master-slave system which can both-way communication between master and slave computer. The bus is a multiple master bus that prevents data corruption through conflict detection and arbitration mechanisms. It is worth noting that the I²C bus has two address bit widths, 7 bits and 10 bits, where 10 bits and 7 bits addresses are compatible that can be used in combination. When the bus is idle, both lines are high level. When any device on the bus output low level, it will make the bus signal goes low, i.e., the signals of multiple devices are "wired and" logic. This special logic relation is the key to bus arbitration. The protocol requires that the data SDA must remain stable while the clock line SCL is high, and the data is usually transmitted in MSB form. As shown in Figure 14-2.

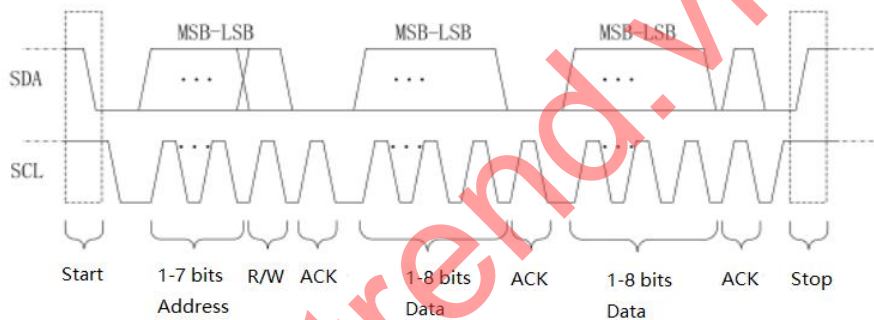

Figure 14-2

(1) Bus Decoding

Refer to [RS232 Bus Decoding](#).

(2) SCL SOURCE

Select SCL source to any one of CH1~CH4 or D0-D15 to be clock input of I²C.

(3) SDA Source

Select SDA source to any one of CH1~CH4 or D0-D15 to be data input of I²C.

14.3 SPI Decoding

SPI (serial peripheral interface) can connect the host with peripheral equipment in serial way to communication. It's full duplex and synchronous communication bus. It's usually use 4 signal connecting line, MOSI: master data output, slave data input; MISO: master input, slave data output; SCLK: clock signal generated by master; CS: chip select enable signal from slave.

SPI interface is mainly used for synchronous serial data transfer between the host and low-speed peripheral equipment. Under the shift pulse of the host, the data is transferred bit by bit, the high bit in front and behind is the low bit. SPI interface is widely used because it does not require slave address addressing, which is full duplex communication and the protocol is simple. SPI protocol transmission

as shown in Figure 14-3.

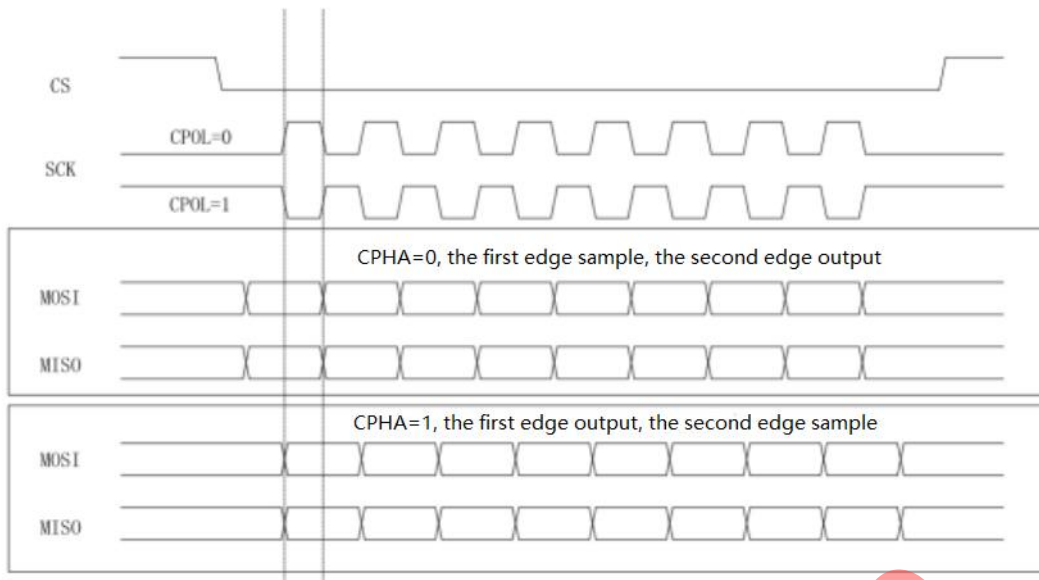

Figure 14-3

Note: The analog channels of the MSO/UP03000E series 2-channel products do not have this feature because the number of output channels needs to be at least 3.

- (1) Bus Decoding
Refer to [RS232 Bus Decoding](#).
- (2) Bit Width
Set the bit width of each frame of SPI protocol signal, which can set to 4~32.
- (3) Bit Order
Specify whether the data bits of the SPI protocol signal to be decoded is high bit at the front (MSB) or low bit at the front (LSB). MSB or LSB can be selected.
 - a. MSB: The high bit of data is transmitted first.
 - b. LSB: The low bit of data is transmitted first.
- (4) CS Source
CS source can set any one of CH1~CH4 or D0-D15 to be chip selection input of SPI decoding signal. The source supports display and select digital channel only when the digital channel is opened in LA.
- (5) SCLK Source
Press SCLK source key to set any one of CH1~CH4 or D0-D15 to be clock source of SPI decoding signal. The source supports display and select digital channel only when the digital channel is opened in LA.
- (6) Data Source
Press MOSI source key to set any one of CH1~CH4 or D0-D15 to be data MOSI input of SPI decoding signal. The source supports display and select digital channel only when the digital channel is opened in LA.
- (7) CS Polarity
Set the polarity of chip selection enable signal to positive or negative.
 - a. Positive polarity: It is 1 when the setting signal is greater than threshold. Otherwise, it is 0.
 - b. Negative polarity: It is 1 when the setting signal is less than threshold. Otherwise, it is 0.
- (8) SCLK Polarity

Set the edge of clock signal to rising edge or falling edge.

- a. Rising edge: It will be generated on the rising edge of clock signal.
- b. Falling edge: It will be generated on the falling edge of clock signal.

(9) Data Polarity

Set the polarity of data signal MOSI to positive or negative.

- a. Positive polarity: It is 1 when the setting signal is greater than threshold. Otherwise, it is 0.
- b. Negative polarity: It is 1 when the setting signal is less than threshold. Otherwise, it is 0.

14.4 CAN Decoding

(1) Bus Decoding

Refer to [RS232 Bus Decoding](#).

(2) Information Source

Set CAN protocol trigger source, which can be CH1, CH2, CH3, CH4 or D0-D15. The current selected source will displayed on the right corner of the screen. The source supports display and select digital channel only the digital channel is opened in LA.

Note: Only the channel that has been connected to the signal, select it as the trigger source that can get the stable trigger and correct decoding.

(3) Signal Type

Set the input signal of the current source is high data line signal or low data line signal, which can select CAN_H or CAN_L.

(4) Bit Rate (bps)

Set the bit rate of CAN bus serial data, which can select 10 k, 20 k, 25 k, 31.25 k, 33.3 k, 37 k, 50 k, 62.5 k, 68.266 k, 83.3 k, 92.238 k, 100 k, 125 k, 153 k, 250 k, 400 k, 500 k, 800 k, 1 M or user-defined. User can input customized bit rate when "user-defined" is selected.

14.5 CAN-FD Decoding

(1) Bus Decoding

Refer to [RS232 Bus Decoding](#).

(2) Information Source

Set CAN-FD protocol trigger source, which can be CH1, CH2, CH3, CH4 or D0-D15. The current selected source display on the right corner of the screen. The source supports display and select digital channel only when the digital channel is opened in LA.

Note: Only the channel that has been connected to the signal, select it as the trigger source that can get the stable trigger and correct decoding.

(3) Signal Type

Set the input signal of the current source is high data line signal or low data line signal, which can select CAN_H or CAN_L.

(4) Bit Rate(bps)

Set the bit rate of CAN-FD bus serial data, which can select 10 k, 20 k, 25 k, 31.25 k, 33.3 k, 37 k, 50 k, 62.5 k, 68.266 k, 83.3 k, 92.238 k, 100 k, 125 k, 153 k, 250 k, 400 k, 500 k, 800 k, 1 M or user-defined. User can input customized bit rate when "user-defined" is selected.

(5) FD Bit Rate

Set FD bit rate of CAN-FD bus serial data, which can select 250 k, 500 k, 800 k, 1 M, 1.5 M, 2 M, 4 M, 6 M, 8 M and user-defined. User can input customized bit rate when "user-defined" is selected.

14.6 LIN Decoding

(1) Bus Decoding

Refer to [RS232 Bus Decoding](#).

(2) Information Source

Set trigger source of LIN protocol, which can be CH1, CH2, CH3, CH4 or D0-D15. The current selected source display on the right corner of the screen. The source supports display and digital channel only when the digital channel is opened in LA.

Note: Only the channel that has been connected to the signal, select it as the trigger source that can get the stable trigger and correct decoding.

(3) Polarity

Set the polarity of the input signal, which can be normal (high=1), inverse (high=0).

(4) Version

Set the version to v1.x, v2.x or random.

(5) Bit Rate (bps)

Set the bit rate of LIN, which can be 1.2 k, 2.4 k, 4.8 k, 9.6 k, 10.417 k, 19.2 k or user-defined. User can input customized bit rate when "user-defined" is selected.

(6) ID Parity Bit

Set ID parity bit to "yes" or "no". If "yes" is selected, it includes parity bit and ID; if "no" is selected, parity bit and ID is not include.

(7) Setup Data Length

Set whether display the setting menu of data length. It can set yes or no.

Yes: Display the setting menu of data length

No: The setting menu of data length is not display.

(8) Data Length

Set LIN data length, the range can set to 1~8. It is only valid when "Setup data length" is "Yes".

14.7 FlexRay Decoding

(1) Bus Decoding

Refer to [RS232 Bus Decoding](#).

(2) Information Source

Set LIN protocol trigger source, which can be CH1, CH2, CH3, CH4 or D0-D15. The current selected source display on the right corner of the screen. The source supports display and select digital channel only when the digital channel is opened in LA.

Note: Only the channel that has been connected to the signal, select it as the trigger source that can get the stable trigger and correct decoding.

(3) Polarity

Polarity can set to BM, BDiff or BP.

(4) Channel Type

Set signal channel type to A or B.

(5) Bit Rate(bps)

Set bit rate, which can be 2.5 M, 5 M, 10 M or user-defined. User can input customized bit rate when "user-defined" is selected.

15. Mathematical Operation

MSO/UP03000E series digital phosphor oscilloscope carries a variety of mathematical operations, it includes MATH, FFT, digital filter and advanced operation.

Enter mathematical operation menu, adjusting POSITION or SCALE knob on vertical control area to change the vertical position and the vertical scale of the waveform. The math operation waveform cannot be independent adjust the horizontal time base scale. It will change automatically according to the horizontal time base scale of the analog input channel.

Math operation cursor  marks the result of a mathematical operation.

- Math Function
- FFT
- Digital Filter
- Advanced Operation

15.1 Mathematical Function

Use operator "+", "-", "x", "÷" to operating the channel waveform to get the math waveform.

(1) Operator

Operator supports "+", "-", "x", "÷".

- a. +: The waveform of source 1 and source 2 are added point by point.
- b. -: The waveform of source 1 and source 2 are subtracted point by point.
- c. x: The waveform of source 1 and source 2 are multiplied point by point.
- d. ÷: The waveform of source 1 and source 2 are divided point by point.

15.2 FFT

Using FFT (Fast Fourier Transform) mathematical operations, the time domain signal (YT) can be converted into frequency domain signal. The following types of signals can be easily observed by using FFT:

- Harmonic content and distortion in measurement system;
- Perform the noise feature in DC power supply;
- Vibration Analysis;

(1) Vertical Unit

The unit of the FFT operation result can select **Vrms** and **dB**. **Vrms** and **dB** display the vertical amplitude size in a linear way and decibel volts way. If the FFT spectrum need to display in a large dynamic range, dB is recommended.

(2) Frequency Range

a. Range

- Start Frequency: Set the start sweep frequency of FTT.
- End of Frequency: Set the end sweep frequency of FTT.
- Reference Frequency: Automatically set start frequency, end of frequency to a fit value for observing the distinct sampling point of peak in FFT waveform.

b. Bandwidth

- Center Frequency: Set the center frequency of the FFT waveform and the FFT waveform will be changed accordingly.
- Bandwidth: Set the bandwidth of FTT sweep.
- Reference Frequency: Set the center frequency of the FFT waveform and the FFT waveform will be changed accordingly.

(3) Count

Perform a data count of FFT operation, it can set to auto, 1 k, 2 k, 4 k, 8 k, 16 k, 32 k, 64 k, 128k, 256 k, 512 k, and 1024 k.

(4) Window

Window function can select Hamming, Blackman, Rectangle or Hanning.

a. Rectangle: It has the best frequency resolution and the worst amplitude resolution, which is similar to the one with no window. It is suitable for measuring the following waveforms:

- Transient or short pulse, the signal level is almost equal to before and after.
- Equal amplitude sine wave with very similar frequency.
- Wide-band random noise in a slowly changing spectrum.

b. Hanning: Compared with the rectangle window, it has better frequency resolution, but poorer amplitude resolution. It is suitable for measuring sine, periodic and narrow-band random noise waveforms.

c. Hamming: The frequency resolution is slightly better than that of Hanning window. It is suitable for measuring transient or short pulse, and the waveform with great difference before and after the signal level.

d. Blackman: It has the best amplitude resolution, and the worst frequency resolution. It is suitable for measuring the single frequency signals or seeking higher harmonics.

(5) Display Mode

Display mode divides into full screen, split screen, independent screen and waterfall curve. FFT wave displays 10 grids in all of the display window and corresponding to the coordinates, it's for observing frequency spectrogram.

a. Split screen: Display the source waveform and the waveform of FFT spectrum waveform in split screen, and extend display the spectrum. As shown in Figure 15-1.

b. Full screen: Superimposed display the source waveform and the FFT spectrum waveform in full screen. User can observe the spectrum more clearly and make more accurate measurements.

c. Independent screen: Only display FFT wave for observing frequency spectrogram more clearly, as shown in Figure 15-2.

- d. Waterfall curve 1: Spectrum, waterfall curve and waveform are separately display in 3 window. Waterfall curve shows the time changing of dB value in spectrum. It has "record" function. Waterfall curve can only select when enhance FFT is opened. The maximum record 200 spectrum which corresponds to waterfall curve.
- e. Waterfall curve 2: Spectrum and waterfall curve split to two window to display. Waterfall curve shows the time changing of dB value in spectrum. It has "record" function. Waterfall curve can only select when enhance FFT is opened. The maximum record 200 spectrum which corresponds to waterfall curve. As shown in Figure 15-3.

Chip selection: In STOP state, use Multipurpose knob or keypad to input fragment. For observing the spectrum waveform in a time point on waterfall curve.

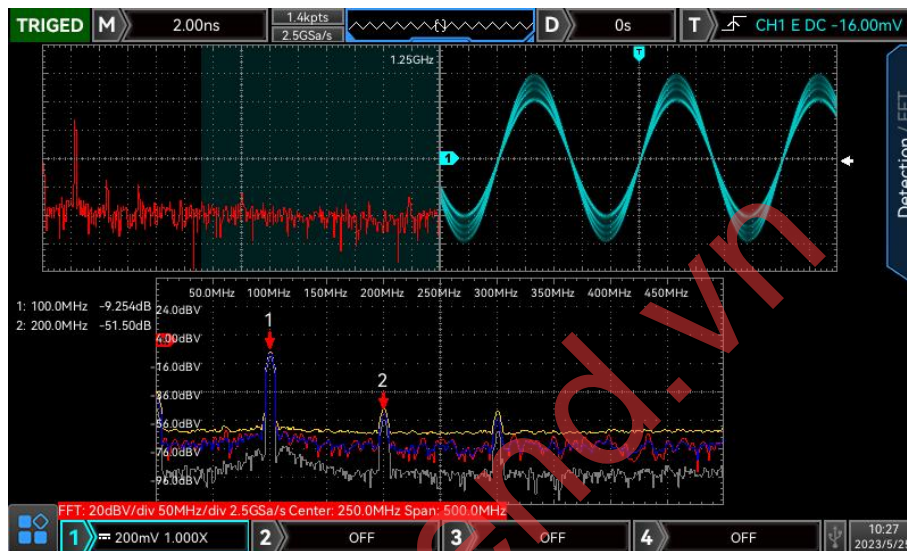

Figure 15-1

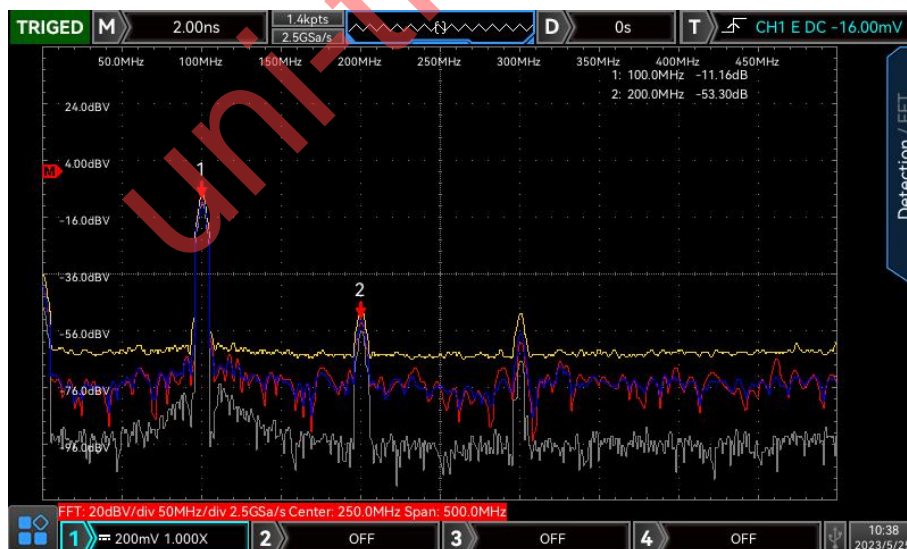

Figure 15-2

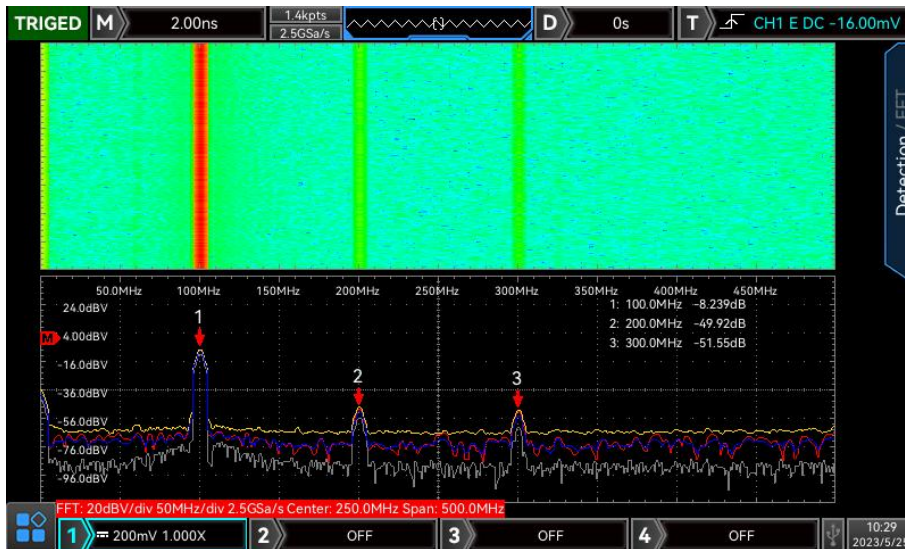

Figure 15-3

(6) FFT - Detecting Mode

The detecting mode is to set the way to display the sampling points of the raw data after FFT operation. The display mode can be set to normal, average, maximum hold and minimum hold. The sampling point mode can be set to + peak, - peak, average and sampling, as shown in Figure 15-4.



Figure 15-4

Display Mode

- Normal: the spectrum waveform displays all sampled values, the corresponding spectrum waveform is displayed in red color.
- Average: the spectrum waveform displays the average value by sampling point in time interval, the corresponding spectrum waveform is displayed in blue color.
Average time: set the number of times of the average calculation, when the average spectrum is enabled, the number of times can set to 2, 4, 8, 16, 32, 64, 128, 256, 512, or 1024. The larger the number, the smoother the average spectrum.
- Maximum hold: the spectrum waveform displays the maximum value among the multiple sampling data, and the corresponding spectrum waveform is displayed in yellow.
- Minimum hold: the spectrum waveform displays the minimum value among the multiple sampling

data, and the corresponding spectrum waveform is displayed in gray.

Sampling Point Mode

- a. OFF: turn off the detection display
- b. + Peak: take the maximum value within the range of each sampling point.
- c. - Peak: take the minimum value within the range of each sampling point.
- d. Average: take the average value within the range of each sampling point.
- e. Interval: perform sampling in the same time interval.

Reset trace: fresh every spectrum data

Note: A detection trace must be displayed in detecting mode. If all detecting mode is not enabled, the default setting is normal detecting trace.

(7) Enhance FFT - Marker

To mark the point in spectrum and display frequency value and voltage value. Mark mode includes auto, threshold and manual.

- a. Auto
 - Mark trace: Select spectrum wave as the marker source, which is the spectrum waveform generated by different detection types under the detecting mode, it can set to normal, average, maximum hold and minimum hold.
 - Maximum count: Set the maximum marker point. The range can set to 1~50.
 - Event list: Display the information of current marker point, which is serial number of point, frequency and voltage.
- b. Threshold
 - Mark trace: Select spectrum wave as the marker source, which is the spectrum waveform generated by different detection types under the detecting mode, it can set to normal, average, maximum hold and minimum hold.
 - Threshold: Set the threshold value as the compare condition. Display the marker point when peak value is greater than threshold. Otherwise, it will not display the marker point.
 - Event list: Display the information of current marker point, which is serial number of point, frequency and voltage.
- c. Manual: Adjust Multipurpose knob to move marker to any point on trace.
 - Mark trace: Select spectrum wave as the marker source, which is the spectrum waveform generated by different detection types under the detecting mode, it can set to normal, average, maximum hold and minimum hold.
 - Maximum peak value: Set manual mark trace to the maximum peak value of sampling point by default.

Note: If the selected mark trace is not display which means there are no mark point. It can be mark only when the mark trace is displayed.

FFT Operation Tips

Signals with DC components or deviations can cause errors or deviations in the FFT waveform components.

To reduce the DC component, the channel can be set to AC coupling.

To reduce the random noise and aliasing frequency components of the repetitive or single pulse, user can set the oscilloscope acquisition mode to average acquisition.

15.3 Digital Filter

- (1) Filter Type
 - a. Low pass : Only signal with the source frequency lower than the upper limit of the current frequency are allowed to pass.
 - b. High pass: Only signal with the frequency higher than the lower limit of the current frequency are allowed to pass.
 - c. Band pass: Only signal with the frequency higher than the lower limit of current frequency and lower than upper limit of the current frequency are allowed to pass.
 - d. Band Limited: Only signal with the frequency lower than the lower limit of the current frequency or higher than the upper limit of the current frequency are allowed to pass.
 - (2) The lower limit of frequency
Adjusting the Multipurpose knob to change the value of the lower limit of frequency. In low pass, the lower limit of frequency is invalid and the menu is hidden.
 - (3) The upper limit of frequency
Adjusting the Multipurpose knob to change the value of the high limit of frequency. In high pass, the high limit of frequency is invalid and the menu is hidden.
- Note:** The range of the upper/lower limit of frequency is related to the current horizontal time base.

15.4 Advanced Operation

User can freely defined the operation of each signal of input channel to get different operation result of MATH waveform.

- (1) Expression
This function can set to turn on/off. Turn on to pop out dialog frame as shown in Figure 15-5.

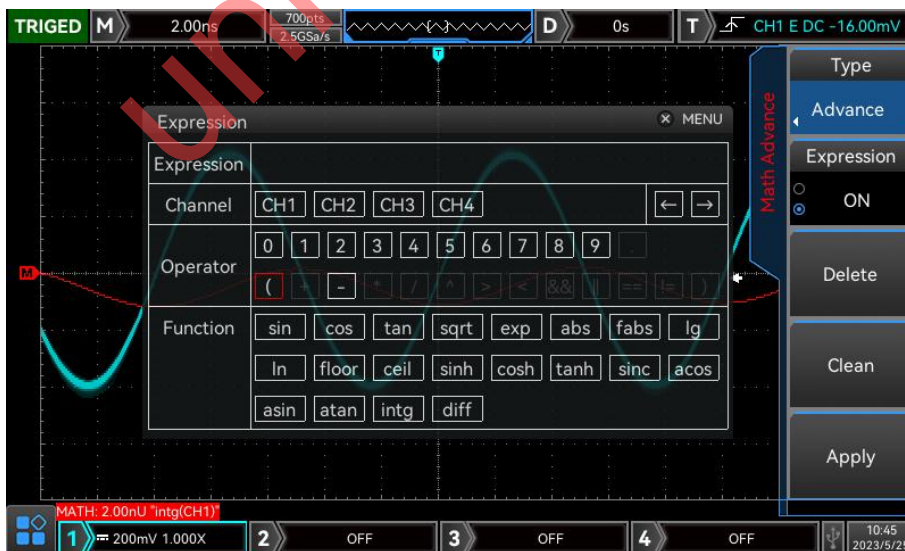

Figure 15-5

Adjust the Multipurpose knob to select "Channel", "Function", or "Operator", then press the knob to display the options in the list after Expression.

When editing the expression, user can press the delete key to "delete", "clear" and "application" the expression. After applying the expression, the oscilloscope performs operations according to the expression and displays the result.

(2) Expression Dialog Frame

- a. exp: It represents the formula consist of channel, function, variation and operator. The length of expression cannot over 40 characters.
- b. Ch: Channel can select to CH1, CH2, CH3 or CH4.
- c. Function: The function of each function option as shown in Table 15-1.

Table 15-1

Function Name	Description of Function
Sin	Calculating the sine of the selected source.
Cos	Calculating the cosine of the selected source.
Sinc	Calculating the normalization value of the selected source.
Tan	Calculating the tangent of the selected source.
Sqrt	Calculating the square root of the selected source.
Exp	Calculating the exponent of the selected source.
Log	Calculating the logarithm of the selected source.
Ln	Calculating the logarithm of the selected source.
floor	The selected source is round down to an integer.
ABS	The selected source take the absolute value (integer absolute value).
acos	Calculating the arccosine of the selected source.
asin	Calculating the arcsine of the selected source.
atan	Calculating the inverse tangent of the selected source.
sinh	Calculating the hyperbolic sine of the selected source.
tanh	Calculating the hyperbolic tangent of the selected source.
cosh	Calculating the hyperbolic cosine of the selected source.
ceil	The selected source is round up to an integer.
fabs	The selected source take the absolute value (floating number absolute value).
intg	Calculating the integral operation of the selected source.
diff	Calculating the differential operation of the selected source.

- d. Opt: The function of each operator as shown in Table 15-2.

Table 15-2

Function Name	Description of Function
+,-,*,/,^	Mathematical operator: add, subtract, multiply, divide, exponent
()	Parenthese is used to raise the priority of operations in parentheses.
<, >, ==, !=	Relation operator: greater than, less than, equal to, unequal to
, &&	Logical operator: or, and

0 ~ 9, .

Perform digit operation

16. Digital Channel

MSO/UP03000E series digital phosphor oscilloscope has 2 analog channel and 16 digital channel. For digital channel, the oscilloscope will compare the sampled voltage of each time to the preset logical threshold. If the voltage of sampling point is greater than threshold, it will be saved as logic 1. Otherwise, it will be saved as logic 0. The oscilloscope can intuitively display the logic 1 and logic 0 in figure. It's convenient for user to detect and analyze the error in circuit design (hardware and software design).

This chapter is to introduce how to use the digital channel of MSO/UP03000E series digital phosphor oscilloscope.

Use the accessory UT-M15 logical probe to connect to the oscilloscope and the device under test before using the digital channel. Application of logical probe refer to UT-M15 Logical Probe User's Manual.

- Open Digital Channel
- Select Digital Channel
- Waveform Size
- Rank Selection
- Threshold Setting
- Data Bus Setting
- Label Setting
- Group Setting
- Event List
- Delay Calibration

16.1 Open Digital Channel

Enter switch setting menu of the digital channel via channel switch.

- (1) Channel selection: Open D0-D15 channel selection list to select turn on/off arbitrary channel. Opened channel indicates and displayed on the screen.
- (2) Turn on/off D7-D0, D15-D8 channel;
- (3) Turn on/off group, the selected group indicates . If the group has digital channel, the channel will be displayed on the screen (user-defined group refer to "Group Setting").

Note: Only digital channel group has set by group setting can be selected.

16.2 Select Digital Channel

The current channel can select any channel, the selected channel will be highlight. Rotary Multipurpose knob to move the selected channel to the desired position.

Note Only the channel that have been displayed on the oscilloscope screen, and the selected to move the position can be effective.

16.3 Waveform Size

Waveform size can set to S, M, and L. The default setting is S.

Note: L (large) display mode is only available if there are no more than 8 channels currently opened, and requires sorting before and then it can take effect.

16.4 Rank Selection

Rank selection can select the waveform in opened channel. Rank order from top to down is "D0-D15" or "D15-D0." The default is "D0-D15".

16.5 Threshold Setting

Threshold setting menu can independently set the threshold level of two group's channel "Type L" and "Type H". When the voltage of input signal is greater than the current threshold, it judge to logic 1. Otherwise, it judge to logic 0.

Type L or Type H can be preset value or user-defined.

- a. Preset value includes TTL, 5.0V CMOS, 3.3V CMOS, 2.5V CMOS, 1.8V CMOS, ECL, PECL, CLDS and 0V. After a type is selected, the threshold level corresponding to that type is applied to the type.
- b. "User-defined": Adjusting Multipurpose knob to set the desired threshold. The range can set to -20.0 V ~ +20.0 V.

16.6 Data Bus Setting

User can set three digital channels D0-D7, D8-D15, D0-D15 or None to data bus according to your needs.

Each data bus value will display in the data or figure format on the bottom of the screen. Three digital channel groups is displayed as data bus. MSO/UP03000E allows user to create 2 data buses.

- (1) Bus: It can be "BUS1" or "BUS2".
- (2) Bus status: Turn on/off data bus.
- (3) Quick selection: Select the corresponding channel group of BUS1 or BUS2, which can be D0-D7, D8-D15, D0-D15 or None.

- (4) Bit: Select the corresponding channel bit of the bus, which can be D0 ~ D15, CH1 or CH2.
- (5) Bit order: Set the bus bit order, which can select "low to high" (D0 locate in low bit) or "high to low" (D0 locate in high bit).
- (6) Clock: Select any one of channel (D0~D15, CH1, CH2) as the reference clock of bus. Select "NULL" means not set the reference clock.
- (7) Edge type: Set sampling edge type of reference clock, which can be "rising edge, falling edge".
- (8) Display type: Select display format of data bus, which can be hexadecimal, decimal, binary system, ASCII or figure. In figure display mode, the oscilloscope will display the bus data to the level of the corresponding value in a specific way. It is convenient to observe the changing trend of bus value, as shown in Figure 16-1.
- (9) Shake proof: Turn on/off shake proof function.
Shake: It indicates the short-term deviation of a signal at a particular moment relative to its ideal time position, as shown in Figure T1 and T2. If the bus is not select the reference clock, the hopping state of each channel will cause the change of the bus data. When bus data changes, unnecessary data will occurs due to the shaking. When shake proof is opened, the bus will not display the change in bus data caused by a certain shake time, but still maintain the valid data.
- (10) Shake time: Rotating outer layer of jog dial knob to adjust shake time with a large stepped value. Rotating inner layer of jog dial knob to adjust shake time with a small stepped value. The range can set to 0ns~50us.

Note: Shake proof and shake time can only be set when data bus has no reference clock.

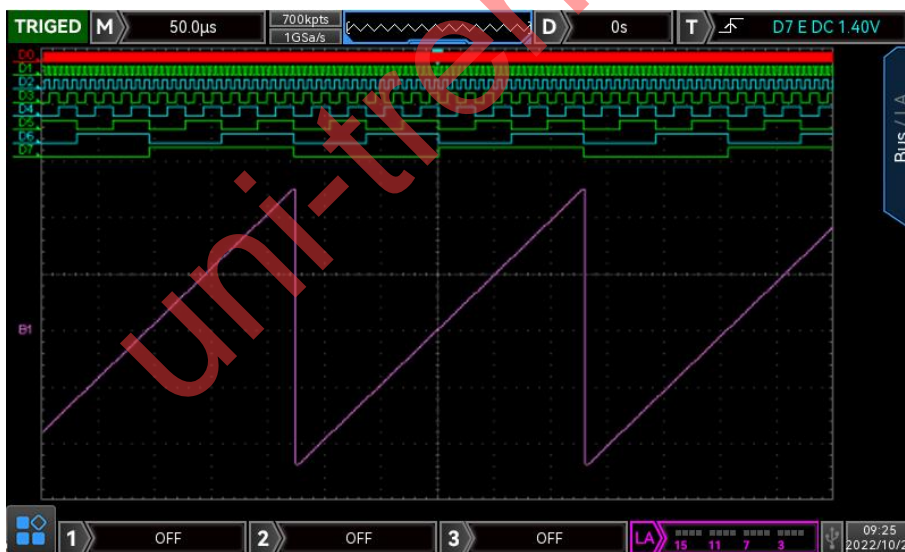

Figure 16-1

16.7 Label Setting

Label setting menu can set label for the specified digital channel. Label can set by preset label or input label.

- (1) Preset Label

Select a digital channel (D0-D15) which need to set label. The label can be select in preset list, which includes ACK, ADO, ADDR, BIT, CAS, CLK, DATA, HALT, INT, UB, NIMI, OUT, PIN, RAS, RDY and RST.

(2) Input Label

Select a digital channel which need to input label (D0-D15). Press input to enter input interface, it can input by manual. The way to input channel label as the following,

The oscilloscope is mark the corresponding channel with its channel number by default (such as **D3**). For the convenience of using, user can set a custom label for each digital channel (such as **D0_A D0**).

Note User-defined label can include capital letter (A-Z), lowercase (a-z), digit (0-9) and special character. The length cannot over 27 characters.

(3) Clear Label

Clear set label in all channel.

16.8 Group Setting

Group setting can random group or cancel group 16 digital channels, it supports divide into 4 groups. A channel can join multiple groups and channel that have been added to a group will display . In each group option box, LA digital graphics display its current selected channel as shown in Figure 16-2.



Figure 16-2

16.9 Event List

Event list displays the data, line number and time after decoding. It is convenience for observing the long decoded data. (This function is only enabled when BUS state is opened.)

16.10 Delay Calibration

When use the oscilloscope to perform the actual measurement, transmit delay of probe cable may cause big error (zero offset).

The zero offset is defined as the offset of the intersection of the waveform and the trigger level line relative to the trigger position.

Adjusting Multipurpose knob to set delay time, which can set to -100 ns ~100 ns.

Note: This parameter setting is related to the instrument's model and the current time base scale size. The greater the time base scale, the larger the setting step.

17. Function/Arbitrary Waveform Generator

MSO/UP03000E has built-in function/arbitrary waveform generator (only for MSO-S). It use direct digital combination technology to generate accurate and stable waveform output with the resolution lower to 1 μ Hz. MSO/UP03000E is economical functional /arbitrary waveform generator.

- Enable Function/Arbitrary Waveform Generator
- Output Basic Waveform
- Advanced Application
- Common Setting

17.1 Enable Function/Arbitrary Waveform Generator

Enable functional /arbitrary waveform generator via **AWG**, as shown in Figure 17-1.



Figure 17-1

- (1) The ① on the above figure is CHA/ CHB information: The currently selected channel will be highlight.
- (2) "Limit" represents output amplitude limit, white is valid, gray is invalid.
 - a. "HighZ" represents the match impedance of output port is high resistance (it can select Highz or 50 Ω . The factory setting is Highz) .
 - b.  represents the currently sine wave. (In different operating mode, it may be "fundamental

wave" "modulating" "OFF".)

- (3) The ② on the above figure is waveform reference list: Display the parameter of waveform in the list format. If an item in the list is in white, then it can use menu operating soft key, numeric keyboard, direction key or Multipurpose knob to adjust the parameter. If the base color of the current character is the color of the current channel (It is white when the system is in setting), which represents the character is in the editing state and can be set with the direction key (as shown in Figure 17-2) or use the numeric keypad or Multipurpose knob to set the parameter.

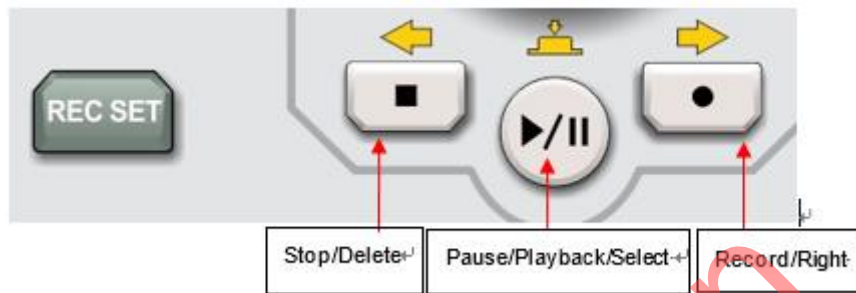

Figure 17-2

- ① Stop : Stop key is left yellow arrow on the above figure. It can move to left when adjusting the numerical value.
- ② Playback/Pause: Playback/Pause key is the yellow arrow in the middle on the above figure. It is for selection when switch the parameter.
- ③ Record: Record key is right yellow arrow on the above figure. It can move to right when adjusting the numerical value.
- (4) The ③ and ④ on the above figure is soft key label: It is for identify the function menu soft key next to it and the current function of the menu operation soft key. Highlighting: Highlighting indicates that the center of the label shows the current channel color or the gray color when the system is in setting and the font is pure white. ③ represents if a label is highlighted, it is selected. ④ displays its indicating content.
- (5) The ⑤ on the above figure is waveform display area: Display the current waveform's shape (It can distinguish which channel is the current waveform by color or the highlight information bar of CH1/CH2. The left parameter list displays the parameter of waveform.)

17.2 Output Basic Waveform

AWG can output basic waveform from single channel or output simultaneously form double channel, which includes sine wave, square wave, slope wave, arbitrary wave and noise wave. After press **AWG** key, the oscilloscope outputs a sine wave with 1 kHz, amplitude 100 mVpp by default. This chapter is to introduce how to configure the oscilloscope to output various types of basic waveforms, take CH1 as an example.

- (1) Set output frequency

When AWG is opened, the oscilloscope outputs a sine wave with 1 kHz, amplitude 100 mVpp by default. It can adjust the frequency value by using the Multipurpose knob or numeric keyboard.

(2) Set output amplitude

The default configuration of waveform is sine wave with amplitude 100 mVpp. It can adjust the amplitude value by using the Multipurpose knob or numeric keyboard.

(3) Set DC Offset Voltage

The DC offset voltage of waveform is 0 V by default. It can adjust the DC Offset voltage value by using the Multipurpose knob or numeric keyboard. DC offset voltage range can set to -2.99 V ~ 2.99 V.

(4) Set the phase

The phase waveform is 0° by default. It can adjust the phase value by using the Multipurpose knob or numeric keyboard. DC offset voltage range can set to -360° ~ 360°.

(5) Set duty cycle of pulse wave

Pulse wave with frequency 1 kHz, duty cycle 50% by default. The duty cycle is limited by the minimum pulse width size 80 ns. It can adjust the duty cycle by using the Multipurpose knob or numeric keyboard. Duty cycle range can set to 1% ~ 99%.

(6) Set symmetry degree of slope wave

Symmetry degree of slope wave is 50% by default. It can adjust the symmetry degree by using the Multipurpose knob or numeric keyboard. Symmetry degree range can set to 0.1% ~ 99.9%.

(7) Set DC voltage

DC voltage is 0 V by default. It can adjust DC voltage value by using the Multipurpose knob or numeric keyboard. DC voltage value range can set to ±3 V (high resistance); ±1.5 V (50 Ω).

(8) Set noise wave

The standard Gauss noise with amplitude 100 mVpp, DC offset 0 V by system default. It can adjust the amplitude value and DC offset value of noise by using the Multipurpose knob or numeric keyboard.

17.3 Advanced Application

AWG can output AM, FM. Press AWG key to turn on function/arbitrary generator and enter the interface, press MENU to turn on modulation. Take CH1 as an example to introduce.

(1) Amplitude Modulating (AM)

In amplitude modulating, modulated waveform is consist of carrier wave and modulating wave. The amplitude of carrier wave will change along with the amplitude of modulating wave.

- Enable amplitude modulating

Press MENU to extend the menu list and press Modulate to select the amplitude modulating as shown in Figure 17-3.

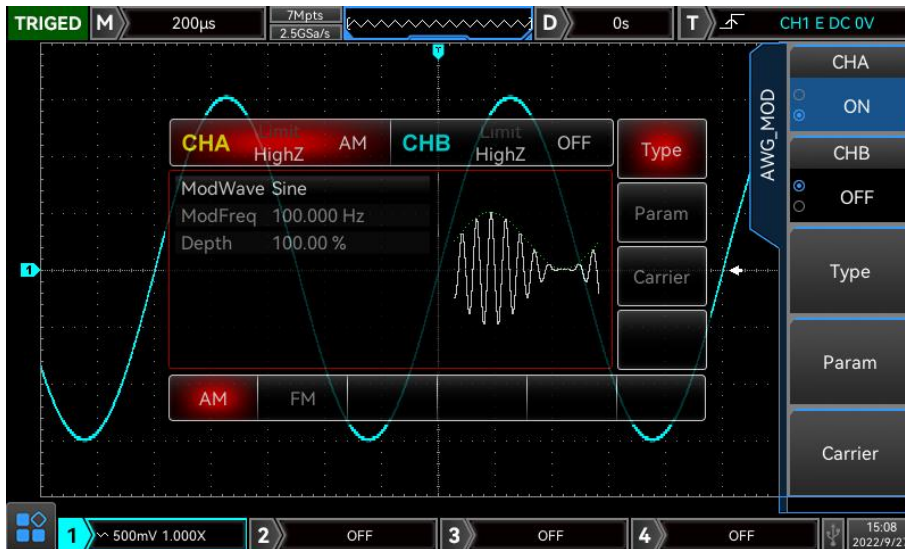

Figure 17-3

- Carrier wave

AM carrier wave can be sine, square, slope, pulse or arbitrary waveform (except DC). The default is sine waveform. After select AM modulating, press **Carrier** soft key to enter the interface, press **Multipurpose** knob to select the desired carrier wave as shown in Figure 17-4.



Figure 17-4

- Carrier frequency

Different carrier wave has different frequency range. The default frequency of all carrier wave is 1 kHz. Frequency range for each carrier wave as shown in Table 17-1.

Table 17-1

Carrier Waveform	Frequency	
	Minimum Value	Maximum Value
Sine Wave	1 μ Hz	50 MHz
Square Wave	1 μ Hz	15 MHz
Ramp Wave	1 μ Hz	400 kHz

Pulse Wave	1 μ Hz	15 MHz
Arbitrary Wave	1 μ Hz	5 MHz

Set carrier frequency after select the carrier wave. Adjusting Multipurpose knob, numeric keyboard to set the frequency value.

- Modulating wave

Modulating wave can be sine wave, square wave, rising slope wave, falling slope wave, arbitrary wave or noise. The default is sine wave. When AM function is enabled, the sine wave will appeared. Adjusting Multipurpose knob to select the desired modulating wave.

- Square wave: duty cycle is 50%
- Rising slope wave: symmetry degree is 100%
- Falling slope wave: symmetry degree is 0%
- Arbitrary wave: select the arbitrary wave as the modulating wave, function/arbitrary waveform generator limits the length of arbitrary wave to 4 kpts by automatic sampling point mode.
- Noise: White Gauss noise
- Set the frequency of modulating wave
Set the frequency of modulating wave to 2mHz~50kHz (the default is 100Hz). When AM function is enabled, the default frequency of modulating wave will be displayed. Adjusting Multipurpose knob, numeric keyboard to set the frequency value.
- Set the depth of modulating wave

Modulating depth indicates the changing of amplitude, it expressed by percentage. AM modulating depth can set to 0%~120%. The default is 50%. Adjusting Multipurpose knob, numeric keyboard to set the modulating value.

- Output a constant amplitude when the modulating depth is 0% (a half of the setting carrier amplitude)
- Output amplitude will change along with modulating wave when the modulating depth is 100%.
- Output amplitude will not over 3 Vpp when the modulating depth is greater than 100%. (Load is 50 Ω .)

(2) Frequency Modulating (FM)

In frequency modulating, the modulated waveform usually consists of a carrier wave and a modulated wave, and the carrier frequency will change with the amplitude of the modulated wave.

- Enable FM modulating

Press MENU to extend menu list, press Modulate to select FM modulating as shown in Figure 17-5.

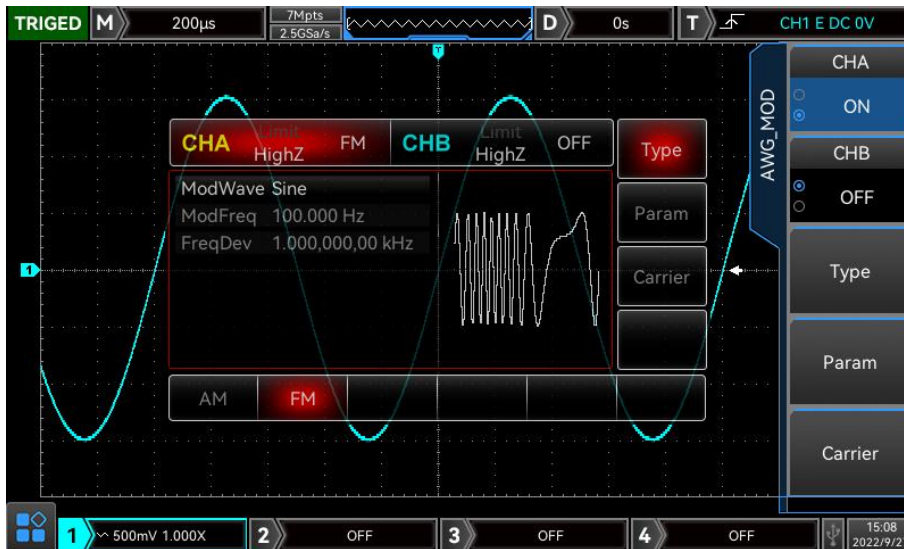

Figure 17-5

- Select carrier waveform

FM carrier waveform can be sine wave, square wave, slope wave, pulse wave or arbitrary wave (except DC). The default is sine wave. After FM modulating is selected, press **Carrier** soft key to enter carrier waveform interface, press **Multipurpose** knob to select the desired carrier waveform, as shown in Figure 17-6.



Figure 17-6

- Carrier frequency

Refer to AM-carrier frequency.

- Modulating wave

Refer to AM-modulating wave

- Set modulating frequency

Set the frequency of modulation wave, the range can set to 2 mHz~50 kHz(the default is 100 Hz). After FM function is enabled, the default frequency 100 Hz will appeared. The frequency value can adjust by using **Multipurpose** knob or numeric keyboard.

- Set frequency offset

Frequency offset represents the deviation of the frequency of the FM modulated waveform relative to the carrier frequency. The FM frequency offset can be set from the minimum DC to half of the maximum of the current carrier bandwidth, and the system default frequency offset is 100 Hz. The frequency value can adjust by using Multipurpose knob or numeric keyboard.

- Frequency offset \leq carrier frequency. If the frequency value is greater than the carrier frequency value, the instrument will automatically limit the offset to the maximum allowed by the current carrier frequency.
- The sum of frequency offset and carrier frequency \leq the maximum frequency allowed by the current carrier. If the frequency offset value is set to an invalid value, the instrument will automatically limit the offset to the maximum allowed by the current carrier frequency.

(3) Output arbitrary wave

This oscilloscope has stored 200 kinds of arbitrary wave, each wave name refer to built-in arbitrary wave list.

- Enable arbitrary wave

Press MENU to extend menu list, press WAVE and select arbitrary wave to enable its function. The oscilloscope will output the arbitrary wave based on the current setting. As shown in Figure 17-7.



Figure 17-7

- Point by point output/ Play mode

AWG supports point-by-point output arbitrary waveform. In point-by-point output mode, the signal generator automatically calculates the frequency of the output signal according by the waveform length and sampling rate. The signal generator outputs waveform points one by one at this frequency. The point-by-point output mode prevents the loss of important waveform points. The default value is no. In this case, the waveform output arbitrary waveform at a fixed length and frequency in the parameter list by means of automatic software interpolation and sampling point. It can adjust Multipurpose knob to Play mode on the arbitrary wave interface and set play mode to "On". The playback mode supports a maximum of 512 k.

- Select arbitrary wave

User can select the arbitrary wave from the oscilloscope's built-in or saved in internal or external of the oscilloscope. When arbitrary wave function is enabled, adjusting Multipurpose knob to select the arbitrary wave from different storage medium.

Built-in arbitrary wave as shown in Table 17-2

Table 17-2

Type	Name	Description
Common Function (11 kinds)	NegRamp	Anti-sawtooth wave
	PPulse	Positive pulse
	NPulse	Negative pulse
	Sinc	Sinc function
	Cardiac	Electrocardiograph
	EEG	Electroencephalogram
	DualTone	Dual tone signal
	AbsSine	Absolute value of sine
	StairDn	Stair down
	StairUp	Stair up
	Trapezia	Trapezia
	BandLimited	Band limited signal
Engine (23 kinds)	BlaseiWave	Blasting vibration "time-vibration" curve
	Butterworth	Butterworth filter
	Chebyshev1	Chebyshev1 filter
	Chebyshev2	Chebyshev2 filter
	Combin	Combination function
	CPulse	C-Pulse signal
	CWPulse	CW pulse signal
	DampedOsc	Damped vibration "time-displacement" curve
	Gamma	Gamma signal
	GateVibar	Gate vibration signal
	LFMPulse	Linear frequency-modulation pulse
	MCNoise	Mechanical execution noise
	Discharge	Discharge curve OF nickel-metal hydride battery
	Pahcur	Brushless DC motor current wave
	Quake	Earthquake wave
	Radar	Radar signal
	Ripple	Power ripple
	RoundHalf	Hemisphere wave
	StepResp	Step response signal
	SwingOsc	Swing oscillation-time curve
	TV	TV signal
Voice	Voice signal	
Maths (26 kinds)	Airy	Airy function
	Besselj	Bessel function of the first kind
	Besselk	Besselk function

	Bessely	Bessel function of the second kind
	Cauchy	Cauchy distribution
	Cubic	Cubic function
	Dirichlet	Dirichlet function
	Erf	Error function
	Erfc	Complementary error function
	ErfcInv	Inverse complementary error function
	ErfInv	Inverse error function
	ExpFall	Exponent fall function
	ExpRise	Exponent rise function
	Gammaln	Napierian logarithm of gamma function
	Gauss	Gauss distribution (normal distribution)
	HaverSine	Haversine function
	Laguerre	4 th degree laguerre polynomial
	Laplace	Laplace distribution
	Legend	5 th legendre Polynomials
	LogNormal	Logarithmic normal distribution
	Lorentz	Lorentz function
	Maxwell	Maxwell distribution
	Rayleigh	Rayleigh distribution
	Versiera	Versiera
	Weibull	Weibull distribution
	ARB_X2	Square function
SectMod (5 kinds)	AM	Sine segment amplitude modulated wave
	FM	Sine segment frequency modulated wave
	PFM	Pulse segment frequency modulated wave
	PM	Sine segment phase modulated wave
	PWM	Pulse width segment frequency modulated wave
Bioelect (4 kinds)	EOG	Electro-Oculogram
	EMG	Electromyography
	Pulseilogram	Ordinary person's sphygmogram
	ResSpeed	Ordinary person's expiration speed curve
Medical (4 kinds)	LFPulse	Low frequency pulse electrotherapy wave
	Tens1	Electrical nerve stimulation wave 1
	Tens2	Electrical nerve stimulation wave 2
	Tens3	Electrical nerve stimulation wave 3
Standard (17 kinds)	Ignition	Ignition of a car's internal combustion engine wave
	ISO16750-2 SP	Starting profile of the car with oscillations
	ISO16750-2 Starting1	Car voltage waveform caused by startup 1
	ISO16750-2 Starting2	Car voltage waveform caused by startup 2
	ISO16750-2 Starting3	Car voltage waveform caused by startup 3
	ISO16750-2 Starting4	Car voltage waveform caused by startup 4
	ISO16750-2 VR	Profile of the car's operating voltage when it resetting

Trigonome (20 kinds)

AntiTrigonome (17 kinds)

ISO7637-2 TP1	Due to power cut-off, it cause transient phenomenon of a car
ISO7637-2 TP2A	Due to the inductance in wiring, it cause transient phenomenon of a car
ISO7637-2 TP2B	Due to boot turn to shut down, it cause transient phenomenon of a car
ISO7637-2 TP3A	Due to the conversion, it cause transient phenomenon of a car
ISO7637-2 TP3B	Due to the conversion, it cause transient phenomenon of a car
ISO7637-2 TP4	Operating profile of the car when it starts booting
ISO7637-2 TP5A	Due to charge and power cut-off, it cause transient phenomenon of a car
ISO7637-2 TP5B	Due to charge and power cut-off, it cause transient phenomenon of a car
SCR	SCR sintering temperature release figure
Surge	Surge Signal
CosH	Hyperbolic cosine
CosInt	Integral cosine
Cot	Cotangent function
CotHCon	Cupped hyperbolic cotangent
CotHPro	Raised hyperbolic cotangent
CscCon	Cupped cosecant
CscPro	Raised cosecant
CotH	Hyperbolic cotangent
CscHCon	Cupped hyperbolic cosecant
CscHPro	Raised hyperbolic cosecant
RecipCon	Cupped reciprocal
RecipPro	Raised reciprocal
SecCon	Cupped secant
SecPro	Raised secant
SecH	Hyperbolic secant
SinH	Hyperbolic sine
SinInt	Integral sine
Sqrt	Square root function
Tan	Tangent function
TanH	Hyperbolic tangent
ACos	Arc cosine function
ACosH	Arc hyperbolic cosine function
ACotCon	Cupped arc cotangent function
ACotPro	Raised arc cotangent function
ACotHCon	Cupped arc hyperbolic cotangent function
ACotHPro	Raised arc hyperbolic cotangent function
ACscCon	Cupped arc cosecant function

	ACscPro	Raised arc cosecant function
	ACscHCon	Cupped arc hyperbolic cosecant function
	ACscHPro	Raised arc hyperbolic cosecant function
	ASecCon	Cupped arc secant function
	ASecPro	Raised arc secant function
	ASecH	Arc hyperbolic function
	ASin	Arc sine function
	ASinH	Arc hyperbolic sine function
	ATan	Arc tangent function
	ATanH	Arc hyperbolic tangent function
Noise (6 kinds)	NoiseBlue	Blue noise
	NoiseBrown	Brown(red) noise
	NoiseGray	Gray noise
	NoisePink	Pink noise
	NoisePurple	Purple noise
	Noisewhite	White noise
Window Function (17 kinds)	Bartlett	Bartlett window
	BarthannWin	CalibratedBarthannwindow
	Blackman	Blackman window
	BlackmanH	BlackmanH window
	BohmanWin	BohmanWin window
	Boxcar	Rectangular window
	ChebWin	Chebyshev window
	GaussWin	Gauss window
	FlattopWin	Flattop window
	Hamming	Hamming window
	Hanning	Hanning window
	Kaiser	Kaiser window
	NuttallWin	Minimum 4 th Blackman-harris window
	ParzenWin	Parzen window
	TaylorWin	Taylor window
	Triang	Triangle window, it's also called Fejer window
	TukeyWin	Tukey window
Complex Wavelets (7 kinds)	Complex Frequency B-spline	Complex Frequency B-spline function
	Complex Gaussian	Complex Gaussian function
	Complex Morlet	Complex Morlet wavelet
	Complex Shannon	Complex Shannon function
	Mexican hat	Mexican hat wavelet
	Meyer	Meyer wavelet
	Morlet	Morlet wavelet
Other (43 kinds)	ABA_1_1	
	ABA_1_2	
	ALT_03	

ALT_04	
ALT_05	
AUDIO	
AbsSineHalf	
AmpALT	
AttALT	
COIL_2_1	
COIL_2_2	
DC_04	
ECT_1_2	
EGR_2	
EGR_3_2	
EST_03_2	
GaussPulse	
Gaussian monopulse	
IAC_1_1	
INJ_1_1	
INJ_2	
INJ_3	
INJ_4	
INJ_5_6	
INJ_7	
KS_1_1	
Log10	
MAF_1_1	
MAF_1_2	
MAF_5_3	
MAP_1_1	
MAP_1_2	
MC_3	
O2PROPA1	
O2PROPA2	
O2SNAP	
RounsPM	
STAR02_1	
SineTra	
SineVer	
StairUD	
TPS_1_1	
TPS_1_2	

17.4 Common Setting

Press **MENU** key to enter menu list, press **Utility** key to set the common parameter of channel, as shown in

Table 17-3.

Table 17-3

Function Menu	Submenu Function	Setting	Description
CHA and CHB Setting	Channel output	OFF, ON	Set the status of channel output. The default is OFF.
	Channel inverse	OFF, ON	Set the status of channel inverse. The default is OFF.
	Load	50Ω, high resistance	Set the channel's load. The default is high resistance.
	Amplitude limit	OFF, ON	Set the status of amplitude limit. The default is OFF.
	Upper limit of amplitude		Set the upper limit of channel amplitude output.
	Lower limit of amplitude		Set the lower limit of channel amplitude output.

18. Additional Function Key

- Automatic Setting
- Run/Stop
- CLEAR
- Factory Setting

18.1 Automatic Setting

Automatic settings will choose appropriate time base scale, amplitude scale and trigger parameter according to the input signal so that the waveform will automatically display on the screen. Press the **AUTO** key to enable automatic settings.

Automatic setting only applies to the following conditions:

- a. Automatic setting is only suitable for simple single frequency signal. It is impossible to achieve effective automatic setting for complex combination waves.
- b. The measured signal frequency is not less than 20 Hz, and the amplitude is not less than 20 mVpp; the duty cycle of square wave is greater than 5%.

18.2 Run/Stop

Use the **RUN/STOP** key on the front panel to set. When press this key and the green light is on, it indicates the RUN state. If the red light is on after the key is pressed, it is the STOP state.

In the running state, the oscilloscope is continuously acquiring waveform and the upper part of the screen shows "AUTO"; in the stop state, the oscilloscope stops the acquisition and the upper part of the

screen shows "STOP". Press the **RUN/STOP** key to switch the waveform sampling between the run and stop states.

18.3 CLEAR

Use the **CLEAR** key on the front panel to set. Press this key to clear the recalled reference waveform on the screen.

18.4 Factory Setting

Press the **DEFAULT** key on the front panel, the oscilloscope can quickly restore to factory setting. MSO/UP03000E series digital phosphor oscilloscope factory settings are as shown in Table 18-1.

Table 18-1

System	Function	Factory Setting
Vertical System	CH1	200 mV/DIV
	Vertical displacement	0(vertical midpoint)
	Zero position	0(vertical midpoint)
	Coupling	DC
	Bandwidth limit	Full bandwidth
	Volts/div scale	Coarse tuning
	Deflection factor of fine tuning	0
	Impedance	1 MΩ
	Probe	1×
	Phase inverse	OFF
	Unit	V
	CH2, CH3, CH4	OFF
	MATH, REF	OFF
Horizontal System	Extension window	OFF
	Split screen display	OFF
	Multi-Scopes	OFF
	Time base selection	Extension time base
	Mode	YT
	XY-CH	CH1-CH2

	Horizontal time base	1 μ s/div
	Horizontal displacement	0(horizontal midpoint)
Trigger System	Trigger mode	Edge
	Trigger polarity1	Rising edge
	Coupling mode	DC
	Trigger condition	Greater than
	Lower limit of time	20 ns
	Upper limit of time	20 ns
	Edge count	1
	Trigger line L position	0
	Trigger line H position	0
	Trigger mode	Auto
	Trigger holdoff	100 ns
	Source 1	CH1
	Source 2	CH1
	Trigger polarity 2	Rising edge
	Video trigger	PAL
	Video trigger synchronization	EVEN
	Video trigger specified line	1
	Display	Format
Grid display		Full display
Transparency of pop out dialog		15%
Menu display		Manual
Backlight brightness		50%
Duration		Minimum
Temperature color		OFF
Anti-temperature		OFF
Grid brightness		50%
Waveform brightness		50%
MATH	Type	MATH
	Source 1	CH1
	Operator	+
	Source 2	CH1
	Probe magnification	x1
	FFT window function	Hamming
	FFT unit	DBM
	FFT count	Auto
	FFT mark mode	OFF
	FFT split screen	OFF

	FFT mark threshold	0
	Digital filter	Low pass
Measurement	Main source of measurement	CH1
	All parameter measurement	OFF
	User-defined parameter	OFF
	Statistics	OFF
	Slave source	CH1
	Indicator enable	OFF
	Indicator	Maximum
Pass/Fail Test	Output	Fail
	Source	CH1
	Display	OFF
	Stop type	Fail time
	Stop condition	Be equal or greater than
	Threshold	1
	Template waveform for reference	CH1
	Horizontal position	5
	Vertical position	5
Bus Decoding	Decoding type	RS232
	Bus state	OFF
	Display format	Hexadecimal
	Event list	OFF
	Bus position	10
	RS232 source	CH1
	RS232 polarity	Negative polarity
	RS232 baud rate	2400
	RS232 user-defined baud rate	9600
	RS232 bit width	7 bits
	RS232 bit order	MSB
	RS232 stop bit	1
	RS232 parity bit	none
	RS232 trigger condition	Start frame
	RS232 data	0
	I ² C SCL	CH1
	I ² C SDA	CH1
	I ² C address bit width	7 bits
	I ² C address	0
	I ² C address mask	0
I ² C operating direction	Write	

	I ² C trigger condition	ON
	I ² C byte size	1
	I ² C data	0
	I ² C subnet mask	0
	SPI CS	CH1
	SPI CLK	CH1
	SPI MOSI	CH1
	SPI MISO	CH1
	SPI CS Polarity	Positive polarity
	SPI CLK Polarity	Positive polarity
	SPI MOSI Polarity	Positive polarity
	SPI MISO Polarity	Positive polarity
	SPI bit order	MSB
	SPI Bit Width	8 bits
	SPI idle time	100 ns
	SPI frame size	1
	SPI MOSI data	0
	SPI MOSI subnet mask	0
LA	Low 8 channel threshold (user-defined)	0
	High 8 channel threshold (user-defined)	0
	Shake proof time of BUS1	0
	Shake proof time of BUS2	0
Other System	Frequency meter	ON
	Square wave output	1 KHz
	Synchronized output	OFF
	SCPI port	USB
	DHCP	Manual
	Language	The current setting
	Sampling mode	Normal sampling
	Average sampling time	2
	Storage depth	Auto
	Cursor type	OFF
	Cursor mode	Independent
	Horizontal unit of cursor	Second
	Cursor channel	CH1
	Automatic channel	Autoset
Automatic sampling	Autoset	

	Automatic trigger	Autoset
	Automatic signal	Autoset
	Current channel selection	CH1
	LA	OFF
	RUN/STOP	RUN

19. System Prompt and Troubleshooting

- Description of System Prompt
- Troubleshooting

19.1 Description of System Prompt

This chapter is to describe the system prompt, the detailed explanation as shown in Table 19-1

Table 19-1

Adjusting is up to extremity !	It is prompt that the adjusting is up to extremity in the current status. It cannot be adjust. It will be prompt when vertical scale rotary knob, time base knob, horizontal displacement, vertical displacement and trigger level, trigger time is up to extremity.
There is no valid data !	It will be prompt when saving waveform.
Warning ! It will clear all saved waveforms and settings.	It will be prompt when using clear function.
Forbidden function !	It will be prompt if open event list when bus is disabled; switch extend serial port in roll mode.
Fail to create a template !	It will be prompt when the selected reference waveform is not opened in Pass/Fail template. It will be prompt when turn on operation to run Pass/Fail test.
There is no record data !	It will be prompt if operating play and stop function when there is no record data.
Attention ! Pass/Fail function is invalid when the scanning is turned on.	It will be prompt when allow to test function is enabled.
I/O operation is failed!	It will be prompt when failed to save Bode data; failed to save waveform.
Attention ! It will restore the system to factory setting.	It will be prompt when using the default function.
Storage is failed, please format USB to	It will be prompt if using USB which is not FAT format to save data.

FAT.	
No USB has detected, please insert USB device !	It will be prompt when USB is not connected.
Remove all input signals.	It will be prompt when using analog channel calibration and LA calibration.
Auto-calibration is completed !	It will be prompt when auto-calibration is completed.
Channel has no signal !	It will be prompt when channel is no signal.
The record function is invalid in Roll mode !	It will be prompt when the oscilloscope operates recording waveform in Roll mode.
There is no parameter can be use, please select user-defined measurement parameter !	It will be prompt if there is no user-defined parameter when turn on measurement statics.
Data storage is successful !	It will be prompt when save waveform, setting file, arbitrary wave is completed.
Data storage is failed !	It will be prompt when save waveform, setting file, arbitrary wave is failed.
Loading file is successful !	It will be prompt when recall saved setting or waveform and it appeared in storage.
Loading file is failed !	It will be prompt if it not appeared in storage when recall saved setting or waveform.
Invalid expression !	It will be prompt when MATH advanced operation and application expression is invalid.
Screenshot is successful !	It will be prompt when save picture or use PrtSc to save picture is completed.
The update path was not fund !	It will be prompt if USB is not insert to provide the update file when the instrument is in updating.
The update file was not fund !	It will be prompt if USB cannot provide the update file when the instrument is in updating.
The filename cannot be empty !	It will be prompt if the filename is empty when save waveform, setting file, arbitrary wave, recording waveform.
Language package is error, please check the language package !	It will be prompt when language package occurs error.
Clear data is successful!	It will be prompt when clear data is finished.
In Multi-Scopes, this function is invalid !	It will be prompt when using extend window, recording waveform, reload waveform, Pass/Fail test, MATH, DECODE, LA, drawing rectangle in Multi-Scopes mode.
The program is in updating, do not reboot !	It will be prompt when the program is in updating.
It cannot canceled during update !	It will be prompt if press cancel function when the program is in updating.
Update is failed, please check the update package and version !	It will be prompt if the update program is not complete when the program is in updating.
Update is completed, reboot system now?	It will be prompt when the program is upgraded.
It is in recording, please exit the recording !	It will be prompt if press other function key when in recording waveform.

In Multi-Scopes mode, the adjustment is up to extremity !	It will be prompt when adjusting horizontal time base is slow to 20 ms.
In XY mode, this function cannot be use !	It will be prompt when open MATH, REF, LA, DECODE function in XY mode.
Start to update ?	It will be prompt when select the update file to upgrade.
The channel is not open !	It will be prompt if the selected channel is not opened in cursor measurement, Pass/Fail template, channel waveform storage, arbitrary waveform storage function.
Turn on allow to test !	It will be prompt when allow to test function is disabled.
Waveform reference channel is not open, there is no valid data !	It will be prompt if REF is not loading adjusting horizontal or vertical when waveform reference is select REF in Pass/Fail test.
It's not allow to test in XY and the main window mode !	It will be prompt when Pass/Fail test and XY mode is enabled.
Turn off scanning !	It will be prompt if press other key when it in scanning.
There is no opened channel, please turn on channel to record !	It will be prompt if all analog channel is turned off when in recording waveform.
In Multi-Scopes, LA is forbidden!	It will be prompt when turn on Multi-Scopes function and then open LA.
In FFT split screen mode, this function is invalid !	It will be prompt when using Pass/Fail test, bode diagram, reload waveform, LA function in FFT split screen, waterfall curve mode.
In FFT split screen mode, Pass/Fail test is forbidden !	It will be prompt when turn on Pass/Fail test function and then open FFT split screen.
The file list is empty !	It will be prompt when if the filename is empty when reload reference waveform, the setting file and bode diagram.
Auto-calibration is canceled !	It will be prompt if press MENU key to cancel auto-calibration when in auto-calibration.
Restored to factory setting, internet parameter is not change !	It will be prompt when SCPI is connect the internet to send factory setting command.
Shunt down, please wait...	It will be prompt when the oscilloscope is shutting down.
Turn off quick record and set record interval !	It will be prompt when set the time interval in quick record.
No correct license is detected. Confirm the purchase and try again !	It will be prompt if there is no correct license when insert USB to activate the optional.
Activation is successful !	It will be prompt when activation license is selected in USB.
This function is not activated, please purchase activation code !	It will be prompt when select the optional after the trail is ended.
The function is in trail. If need to use it in the long run, please purchase activation code !	It will be prompt if select the optional when it in trail.

19.2 Troubleshooting

- (1) When press the button, the oscilloscope is blank screen.
 - a. Check whether the power is correctly connected, power supply is normal or not.
 - b. Check whether the power switch is really turned on. The soft power switch button should light in green when the instrument is normal boot. And it should have relay sound.
 - c. If there is a relay sound, it indicates that the oscilloscope starts normally.
Try the following steps: press the **DEFAULT** key, then press **F1**, if device returns to normal, it means backlight brightness is set too low.
 - d. After completing the above steps, restart the oscilloscope.
 - e. If the instrument still cannot work, please contact UNI-T.
- (2) After signal acquisition, signal of waveform does not appear on the screen.
 - a. Check whether BNC port is connected properly.
 - b. Check whether the signal output channel has turned on.
 - c. Check whether the input signal channel has turned on.
 - d. Check whether has DC displacement in signal of information source.
 - e. Plug out the input signal, check whether the baseline is in the screen range (if not, please perform auto-calibration.)
 - f. If the instrument still cannot work, please contact UNI-T.
- (3) The measured voltage amplitude value is 10 times larger or smaller than the actual value: Check the channel probe attenuation coefficient setting is consistent with the used probe attenuation rate.
- (4) There is a waveform display but not stable
 - a. Check the trigger source in the trigger menu and confirm that it matches the input channel of the actual signal.
 - b. Check the trigger type: general signal should use "Edge" trigger. The waveform can display stably only the proper trigger type is used.
 - c. Change the trigger coupling setting to high-frequency or low-frequency reject, in order to filter out the high-frequency or low-frequency noise that interferes with the trigger.
- (5) No display after pressing **Run/Stop** button
 - a. Check whether the mode at the trigger panel (TRIGGER) is on "Normal" or "Single" and whether the trigger level exceeds the waveform range.
 - b. If it exceeds, set the trigger level to the middle or set the trigger mode to **Auto**.
 - c. Press **AUTO** button could automatically finish the above setting.
- (6) Waveform refresh is very slow
 - a. Check whether the acquisition method is average and the average times are large.
 - b. Check whether the holdoff time is large.
 - c. Check whether is single trigger and the current setting is slow time base scale.
 - d. The above will cause slow refreshing of the waveform. It is advised to restore to the factory setting. Waveform can be refresh normally.

20. Appendix

20.1 Appendix A Maintenance and Cleaning

(1) General Maintenance

Keep the instrument away from the direct sunlight.

Caution

Keep sprays, liquids and solvents away from the instrument or probe to avoid damaging the instrument or probe.

(2) Cleaning

Check the instrument frequently according to the operating condition. Follow these steps to clean the external surface of the instrument:

- a. Please use a soft cloth to wipe the dust outside the instrument.
- b. When cleaning the LCD screen, please pay attention and protect the transparent LCD screen.
- c. When cleaning the dust screen, use a screwdriver to remove the screws of the dust cover and then remove the dust screen. After cleaning, install the dust screen in sequence.
- d. Please disconnect the power supply, then wipe the instrument with a damp but not dripping soft cloth. Do not use any abrasive chemical cleaning agent on the instrument or probes.

Warning

Please confirm that the instrument is completely dry before use, to avoid electrical shorts or even personal injury caused by moisture.

20.2 Appendix B Warranty Overview

UNI-T (UNI-TREND TECHNOLOGY (CHINA) CO., LTD.) ensures the production and sale of products, from authorized dealer's delivery date of one year, without any defects in materials and workmanship. If the product is proven to be defective within this period, UNI-T will repair or replace the product in accordance with the detailed provisions of the warranty.

To arrange for repair or acquire warranty form, please contact the nearest UNI-T sales and repair department.

In addition to permit provided by this summary or other applicable insurance guarantee, UNI-T does not provide any other explicit or implied guarantee, including but not limited to the product trading and special purpose for any implied warranties.

In any case, UNI-T does not bear any responsibility for indirect, special, or consequential loss.

20.3 Appendix C Contact Us

If the use of this product has caused any inconvenience, if you in mainland China you can contact UNI-T company directly.

Service support: 8am to 5.30pm (UTC+8), Monday to Friday or via email. Our email address is infosh@uni-trend.com.cn

For product support outside mainland China, please contact your local UNI-T distributor or sales center. Many UNI-T products have the option of extending the warranty and calibration period, please contact your local UNI-T dealer or sales center.

To obtain the address list of our service centers, please visit our website at URL: <http://www.uni-trend.com>

uni-trend.vn